

Product Catalogue 2022



Model Production

Dosing Scales	DSW-2/ -2/4 K	8–9
Vacuum Mixers	Wamix-Touch/ Wamix-Touch Injector	10–11
Power Vibrators	KV-16/ -26 / -26 plus/ -36 / -56	12–13
Trimmers	HSS-99	14–15
	HSS-88	16–17
	HSS-AZ/ -ZA	18–19
Grinding Discs		20–21

Modelling

Steam Cleaners	Wasi-Steam Compact	24–25
	Wasi-Steam Classic II	26–27
Boil Out Units	Wapo-Ex 12 II	28–29
Boil Out and Polymerisation Unit	Wapo-Ex 8 Plus	30–31
Polymerisation Unit	Wapo-Mat III	32–33
Pressure Polymerisation Units and Compactors	Polyquick 260-T105	34–35
	Polyquick 160-T95	36–37
Compactors	DEG-1/ -2	38–39
Dosing and Mixing Unit	Sidomix II	40–41
Hydraulic Press	WW-33	42–43
Ejection Press	APR-1	44–45

Surface Finish

Fine Blasting Units	Cemat-4 II, Cemat-3 II, Cemat-2 II	48–49
	Gobi Comfort-4, Gobi Comfort-3, Gobi Comfort-2	50–51
	Gobi Classic	52–53
	Puna II	54–55
Polishing Compact Units	WP-Ex 3000 II/ 2000 II	56–57
	WP-Ex 10 II	58–59
Polishing Motor	WSM-2	60–61
Automatic Stand		62–63

Suction Technology

Suction Units	SG-10	66–67
	SG-1/1	68–69
	SG-1/2 D	70–71
Suction Drawers	LSG-02 DE/ D	72–73
Mobile Suction Table with Motor Handpiece	Timobil	74–75
Suction Box	Suction Box Compact III	76–77
Accessories Suction Technology		78–79

Consumable Materials

Duplicating Silicone	WaSil soft/ WaSil speed and Accessories	82–83
Blasting Materials	Aluminium Oxide and Glass Beads	84

Service and Contact Information		86–87
---------------------------------------	--	-------

Imprint		88
---------------	--	----



Office building

MADE IN GERMANY

Wassermann is a medium-sized, owner-operated company with head office in Hamburg. We design and produce high-quality technical devices in Germany. Our main users are dental laboratories, dental clinics and various industrial areas worldwide.

Welcome to Wassermann

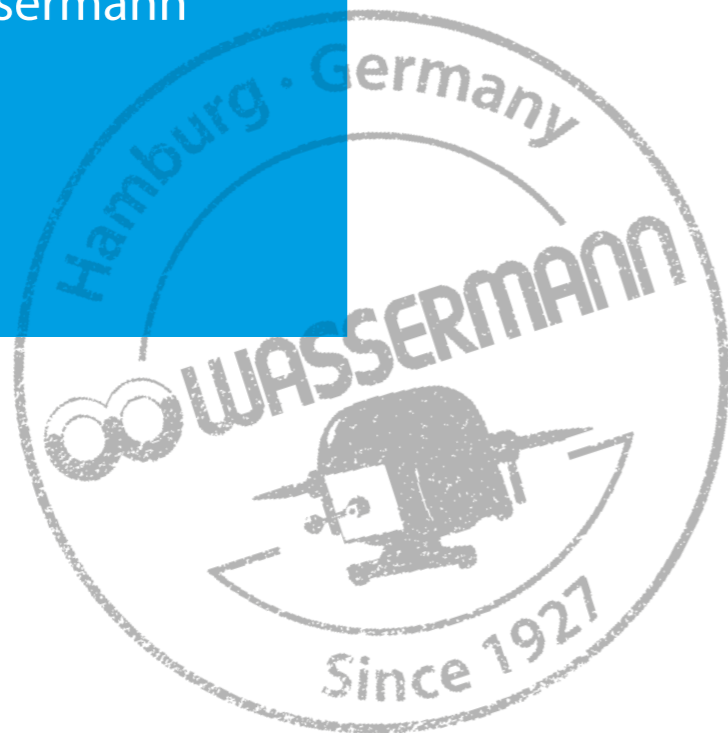

Why a Wassermann product?

Wassermann products are manufactured from high-quality materials and the proportion of plastics used is intentionally kept as low as possible. Our devices are known for their suitability for daily use, functionality and longevity. As a result, the users place high levels of trust in the Wassermann brand. We feel it is our duty to support our customers on a daily basis when it comes to safety, service and productivity. Technological perfection, optimum quality and especially sustainability are the benchmarks we set. Thanks to the combination of these values, the family-owned company, since its establishment in 1927, has gained worldwide recognition as a manufacturer of high-quality products.

Your demands are our obligation

We know: Only top-quality equipment that's ideally suited to its purpose can produce satisfied customers. And that's the goal of our 50 employees – day after day. Because we want to confirm your decision to choose Wassermann again and again. Through individual solutions tailored to meet your needs and desires.

Skill from one source

Fact is: From the first idea to dispatch, from production to sales and service – every Wassermann product is designed and manufactured at our HQ in Hamburg German quality for worldwide use.

Optimal quality management

Perfection and efficiency are Wassermann bywords. We combine tried and true methods of fine machining with the most modern design and manufacturing tools, such as CAD and CNC. That is why all Wassermann equipment is made to the highest manufacturing standards. Perfect products and maximum collaboration from all departments involved. Our DIN EN ISO 9001-certified quality management system is your guarantee.

An investment for the future

The result is dental laboratory equipment of unparalleled value and unmatched durability. And service you can rely on at any time. Not to mention spare parts permanently in stock.



High rack storage area



Production halls



Showroom

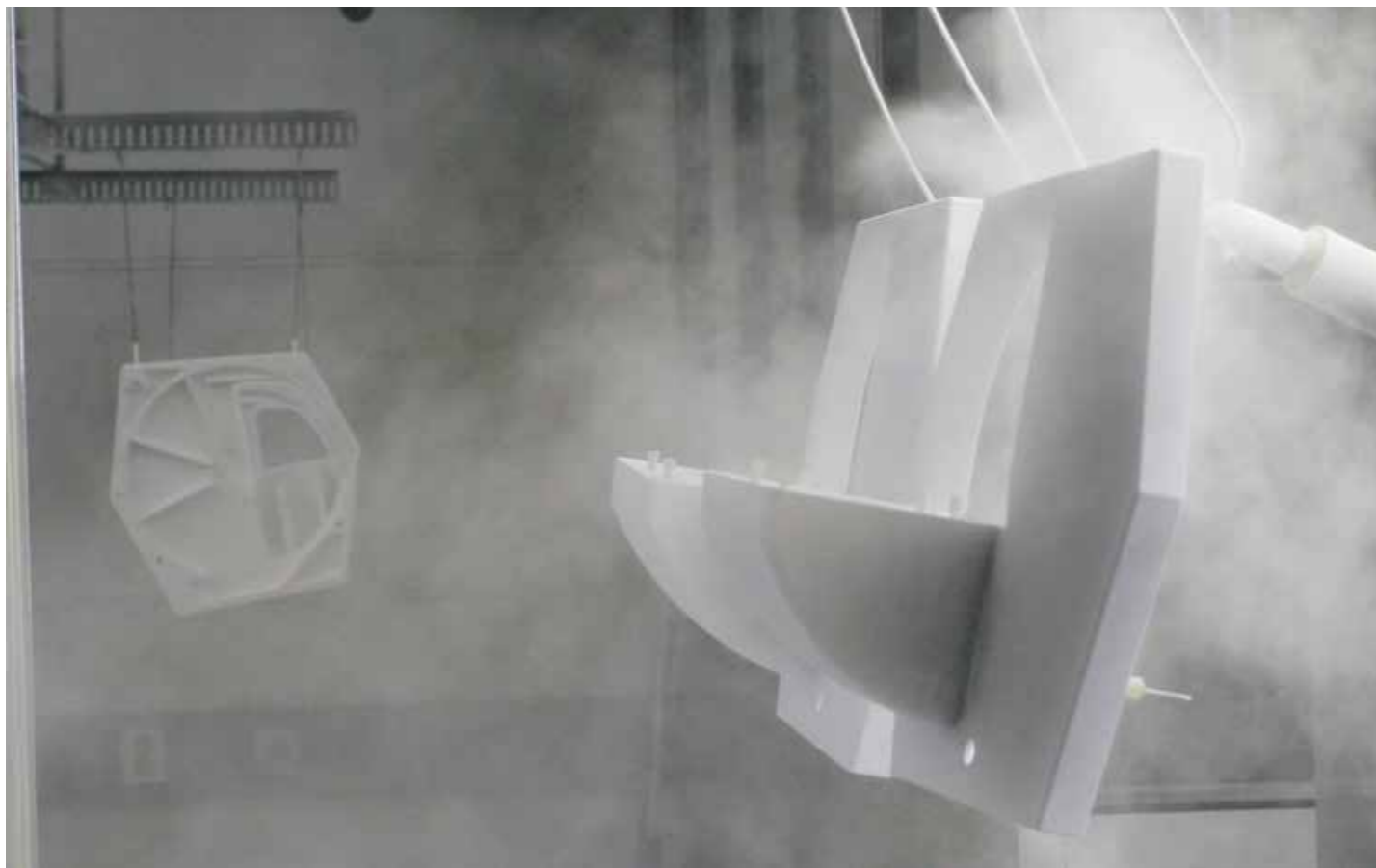

Plastic powder coating
at our site in Hamburg

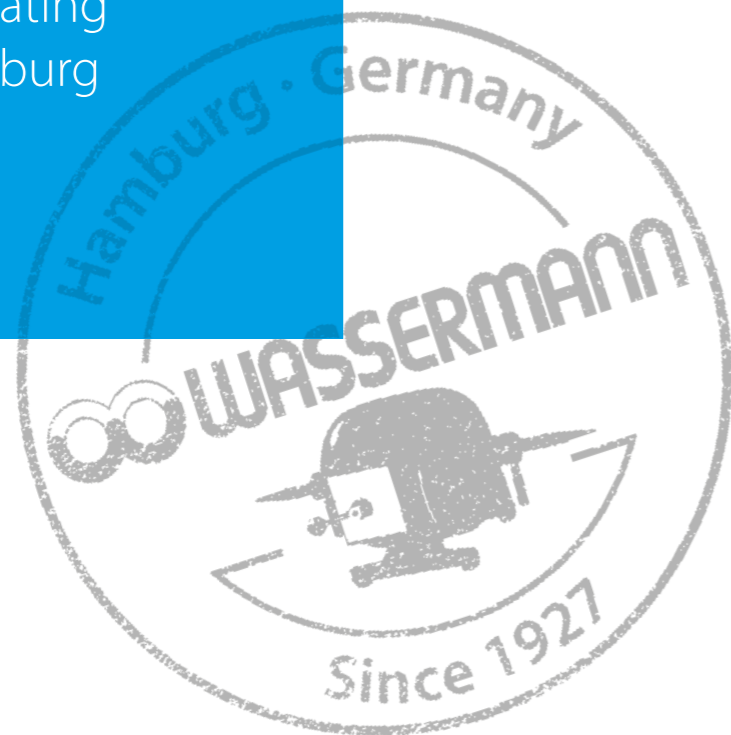

Dosing Scales DSW-2/4K & DSW-2

Indispensable for precise mixing: The DSW-2 and DSW-2/4 K dosing scales make it easy to get exact mixing ratios and reproducible results. The powder is weighed, the required amount of liquid will be added automatically. All pumps can be individually controlled.

The DSW-2/4 K has also a special cooling system to keep the liquid at the set temperature (17 °C, 19 °C or 21 °C).

Major Features

- Precision scales for modern dosing and weighing technologies
- For all common plasters and embedding materials
- Constant mixing ratios of powder and liquids
- Extremely durable, easy to clean housing
- DSW-2/4K comes as standard with 4 pumps for cooled liquids, it is possible to add 2 additional pumps (non-cooled)
- DSW-2 comes as standard with 1 pump non-cooled, it is possible to add 5 additional pumps (non-cooled)
- **Included in delivery:**
DSW-2/4K with 4 pumps, cooled
DSW-2 with 1 pump, non-cooled



DSW-2



DSW-2/4K with temperature ranges cooling system

Large, clear LCD display

Memory for up to 30 mixing recipes

Durable housing, plastic powder coated

Scales in high-quality stainless steel, easy to clean



Accessories	Item no.
Upgrade at one pump, non-cooled	172299
DSW-2/4K	Item no. 172989
DSW-2	Item no. 172988
Voltage	220–240 V / 50/60 Hz
Power consumption DSW-2/4K	0.7 A
Power consumption DSW-2	0.5 A
Output DSW-2/4K	100 W
Output DSW-2	75 W
W x H x D	210 x 470 x 410 mm
Weight DSW-2/4K	17.5 kg
Weight DSW-2	13.0 kg
Weighing range	min.=5 g, max.=6000 g, min. dosing quantity (e)=2 g
Weighing accuracy	+/- 0.5 g
Temperature operative range	5 – 35 °C
Temperature ranges cooling system DSW-2/4K	17 °C, 19 °C, 21 °C



Other voltages on request · Technical changes reserved

Vacuum Mixers **Wamix-Touch & Wamix-Touch Injector**

The **Wamix**-mixers by Wassermann impress with their perfect and bubble free results. They are easy to operate and extremely robust, which makes work much easier for sure. A touch screen and the newly developed control panel allow the user to set the relevant parameters quickly and easily. The technological highlights of the Wamix Series provide the foundation for first class products - quick and reproducible.

Innovative: The vacuum and speed values set by the user are controlled by a microcontroller and are automatically readjusted.

High quality metal components, almost maintenance-free

Visual and audible signal at programme end

Visual safety system helps to identify overfilling, additionally with protective filter against taking up liquids

Silencer Wamix-Touch Injector (Wamix-Touch: Silencer integrated in the unit)

Can be installed flexibly as a wall or counter device, table stand available as extras

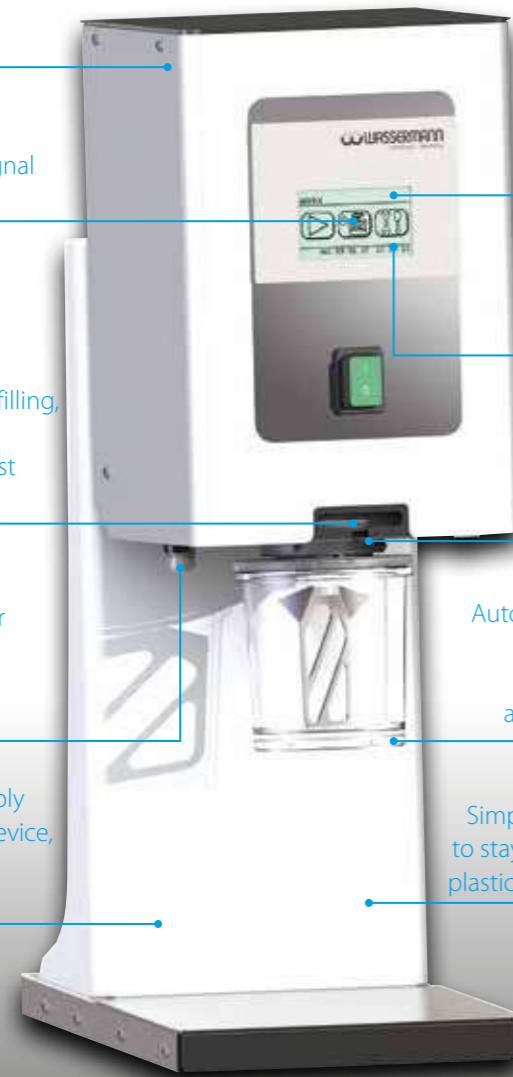

Quick and reproducible processes: You can save 30 programs with your choice of names and access them at any time

Beaker vented only after confirmation, post-vacuum also reduces gas inclusions

Inclined motor for easy insertion of the mixer beaker, comfortable single-hand operation, optimum mixing results

Automatic mixing when beaker is applied, programmable pre-mixing mode with right and left operation, adjustable change of rotation direction

Simple cleaning due to stay-clean surfaces, plastic powder coated

Other voltages on request · Technical changes reserved

Wamix-Touch: The high-capacity and maintenance-free vacuum pump and the speed regulation of the mixer unit makes this unit well-suited to all kinds of plaster, embedding compounds and silicones. Depending on the application three vacuum levels are adjustable. Since it just requires a single power supply connection, the selection of the location is very flexible.

Wamix-Touch Injector: Vacuum is achieved rapidly with this process even for large volumes, thus saving time. Another advantage is the robustness of the highly efficient, oil-free and maintenance-free vacuum generator. Compressed air supply is required.



Wall fastening, mounting set included in delivery



1000 ml, 600 ml, 350 ml, 200 ml und 75 ml

Major Features

- Reproducibility at the push of a button: Vacuum and speed monitoring guarantee homogeneous mixing of all kinds of plaster, embedding materials and silicones
- **Included in delivery:** Beaker, medium cpl. 350 ml
Mounting set for wall fastening
Compressed air hose, 2 m **Wamix-Touch Injector**

Accessories	Item no.
Table stand (W 208 x H 450 x D 275 mm)	171744
Beaker, extra small cpl. 75 ml	171295
Beaker, small cpl. 200 ml	171230
Beaker, medium cpl. 350 ml	171283
Beaker, large cpl. 600 ml	171237
Beaker, extra large cpl. 1000 ml	171269
Vacuum washing beaker, 600 ml	171275
Compressed air hose per meter	320026

Wamix-Touch	Item no. 171970
Wamix-Touch Injector	Item no. 171971
Voltage	100–240 V / 50/60 Hz
Power consumption max. Wamix-Touch	0.44 A (Si 4.0 A)
Power consumption max. Wamix-Touch Injector	0.17 A (Si 4.0 A)
Output Wamix-Touch	94 W
Output Wamix-Touch Injector	40 W
Speed (Motor control with intelligent regulation)	100 – 550 min ⁻¹
Vacuum Wamix-Touch	approx. 120 mbar (absolute)
Vacuum Wamix-Touch Injector	approx. 100 mbar (absolute)
Mixing time	999 sec. adjustable
W x H* x D (wall fastening)	200 x 310 x 200 mm
W x H x D (with stand)	210 x 590 x 300 mm
Weight Wamix-Touch	9.3 kg
Weight Wamix-Touch Injector	7.5 kg
Sound level	≤ 80 dB (A)
Safety class	IP 22
Compressed air connection Wamix-Touch Injector	min. 5 bar

*Leave at least 300-350 mm free space beneath the unit.

Power Vibrators KV-56, KV-36, KV-26 plus, KV-26 & KV-16

Solid, strong and sturdy. Powerful vibrators from Wassermann can meet any challenge. Even vibration over the entire table as well as powerful vibration intensity is guaranteed. All machines are designed for continuous operation and can be switched from 3000 to 6000 oscillations – KV-56, KV-36 and KV-26 plus with infinitely adjustable vibration intensity.

Stainless steel yoke,
perfect for
removing casts



Removable and
washable rubber supports

Vibration damping feet

KV-16, KV-26, KV-26 plus and KV-36 are made entirely of high quality stainless steel. The extremely robust housing is available in the versions "plastic powder coated" and "matt".

Other voltages on request · Technical changes reserved

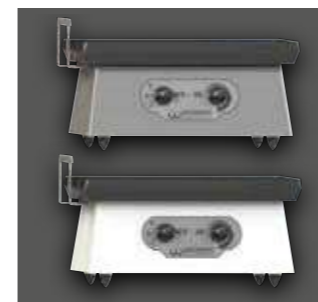

KV-36, white and matt



KV-26 plus, white and matt

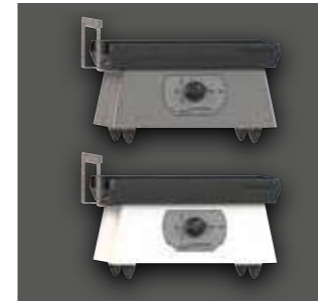

KV-26, white and matt

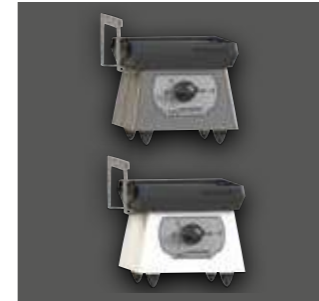

KV-16, white and matt



KV-56, durable cast housing, plastic powder coated



Major Features

- Durable and designed for continuous operation
- System for dampening vibrations minimises relay of vibrations to the work environment

Accessories	Item no.
Spare rubber plate KV-56	169510
Spare rubber plate KV-36	169010
Spare rubber plate KV-26 plus, KV-26	169101
Spare rubber plate KV-16	169201
KV-56 white	Item no. 169997
KV-36 white	Item no. 169999
KV-26 plus white	Item no. 169992
KV-26 white	Item no. 169996
KV-16 white	Item no. 169998
KV-36 matt	Item no. 169989
KV-26 plus matt	Item no. 169988
KV-26 matt	Item no. 169987
KV-16 matt	Item no. 169986
Voltage	220–240 V / 50/60 Hz
Power consumption KV-56	1.3 A
Power consumption KV-36	0.6 A
Power consumption KV-26 plus, KV-26, KV-16	0.3 A
Output KV-56	282 W
Output KV-36	130 W
Output KV-26 plus, KV-26, KV-16	70 W
W x H x D KV-56	445 x 187 x 286 mm
W x H x D KV-36	308 x 173 x 208 mm
W x H x D KV-26 plus, KV-26	228 x 150 x 143 mm
W x H x D KV-16	145 x 150 x 143 mm
Weight KV-56	18.6 kg
Weight KV-36	10.9 kg
Weight KV-26 plus, KV-26	5.2 kg
Weight KV-16	3.9 kg
Table dimensions KV-56	430 x 286 mm
Table dimensions KV-36	293 x 200 mm
Table dimensions KV-26 plus, KV-26	210 x 130 mm
Table dimensions KV-16	130 x 130 mm
Vibrating intensity	3000 / 6000 vibr./min
Vibrating intensity KV-56, KV-36, KV-26 plus	infinitely variable
Sound level KV-56	≤ 70 dB(A)
Sound level KV-36, KV-26 plus, KV-26, KV-16	≤ 59 dB(A)
Safety class	IP 54

The power pack for all occasions: With its powerful 1200 Watt motor the **HSS-99** is suitable for the hardest plasters. Its especially large disc and maximised working section also allow large models to be trimmed. The HSS-99 enables efficient grinding of plaster jaw models and has been designed especially for orthodontics. The top model of the Wassermann plaster trimmer range is the result of years of experience and development based on extensive discussions with laboratories and medical centers. The result: Perfection down to the last detail.

Extendable by orthodontic model table and/or laser light guide for 3 D trimming, ideal for orthodontics

Extra large work section of 120 x 170 mm

Deposit table made of stainless steel

Fully diamond coated grinding disc for smooth and even model surfaces, 300 mm

Inclined support, removable

High-quality housing, plastic powder coated

Convertible drain supports for easier installation even in difficult drain situations



Other voltages on request · Technical changes reserved

Trimmer **HSS-99** for Orthodontics

For bite orientated trimming of plaster jaw models

- Rational and accurate method of trimming
- Exact consideration of all skull levels
- According to Begg (Swiss and EOS version on request)
- Careful attention of the fazilian soft parts ratio
- Dysgnathien immediately noticeable



The **orthodontic model table KMS** allows to produce exact models, after a short trial period the working time is noticeably shorter, than with the usual method.

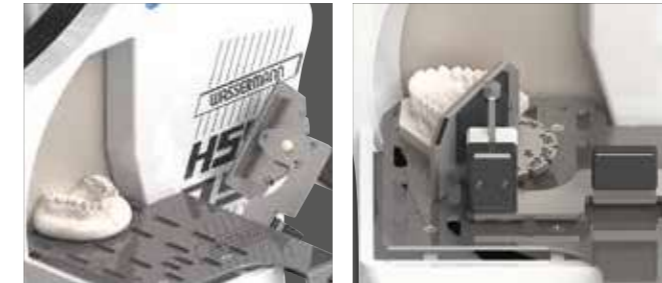

Lockable angle stop, with application-oriented angle engraving, swivels for unrestricted freedom of movement.



Laser light guide: Combination of daylight LED and laser, precise and without glare or reflections. Consequently, it is possible to exactly grind the tuber level of the upper jaw by aligning the Raphe-Median-Line to the ghost line.



Orthodontic template for the upper jaw to grind the tuber level of the lower jaw, a continual inspection of the joint tuber levels during grinding is no longer necessary.

- High grinding speed of 3000 min⁻¹
- Extremely powerful, maintenance-free 1200 Watt motor for high efficiency, splash-protected as per IP 54
- Optimal water control using ball valve and solenoid valve
- Powerful rinsing of disc and interior prevents soiling of the trimmer disc
- Sturdy, oxidation-free bench with longitudinal slots and side openings – avoids water spills
- Easy to open using rear handles, no tool kit necessary
- The orthodontic model table KMS can be delivered also in Swiss and EOS version
- **Included in delivery:**
Inclined support
Supply hose, 1 m
Discharge hose, 1 m

Accessories	Item no.
Spare diamond grinding disc, incl. puller and grease	164063
Sealing grease for trimmer, 25 ml	629002
Puller for grinding disc change	164026
Orthodontic accessories for producing 3D orthodontic models	
Orthodontic model table KMS according to Begg	164130
Laser light guide for model table, cpl.	164110
Orthodontic template for the upper jaw (to grind the lower jaw/tuber level)	164034

HSS-99 incl. diamond grinding disc	Item no. 164998
Voltage	220–240 V / 50/60 Hz
Power consumption	5.5 A
Output	1200 W
W x H x D	400 x 430 x 470 mm
Weight without grinding disc	33 kg
Sound level	65 dB (A)
Speed	3000 min ⁻¹
Duty	S6–40 %
Table dimensions projecting	160 mm

Trimmer HSS-88

The classic among wet trimmers - powerful, flexible and durable: The multi-faceted **HSS-88** by Wassermann is the most sold trimmer for good reason. Its high torque and high speed, but also energy efficient motor guarantees the highest grinding speed. This maintenance-free motor does not require fans or cooling fins, since the motor is cooled through the outer casing. And of course it is needless to say that the trimmer operates with very little noise and no vibration.

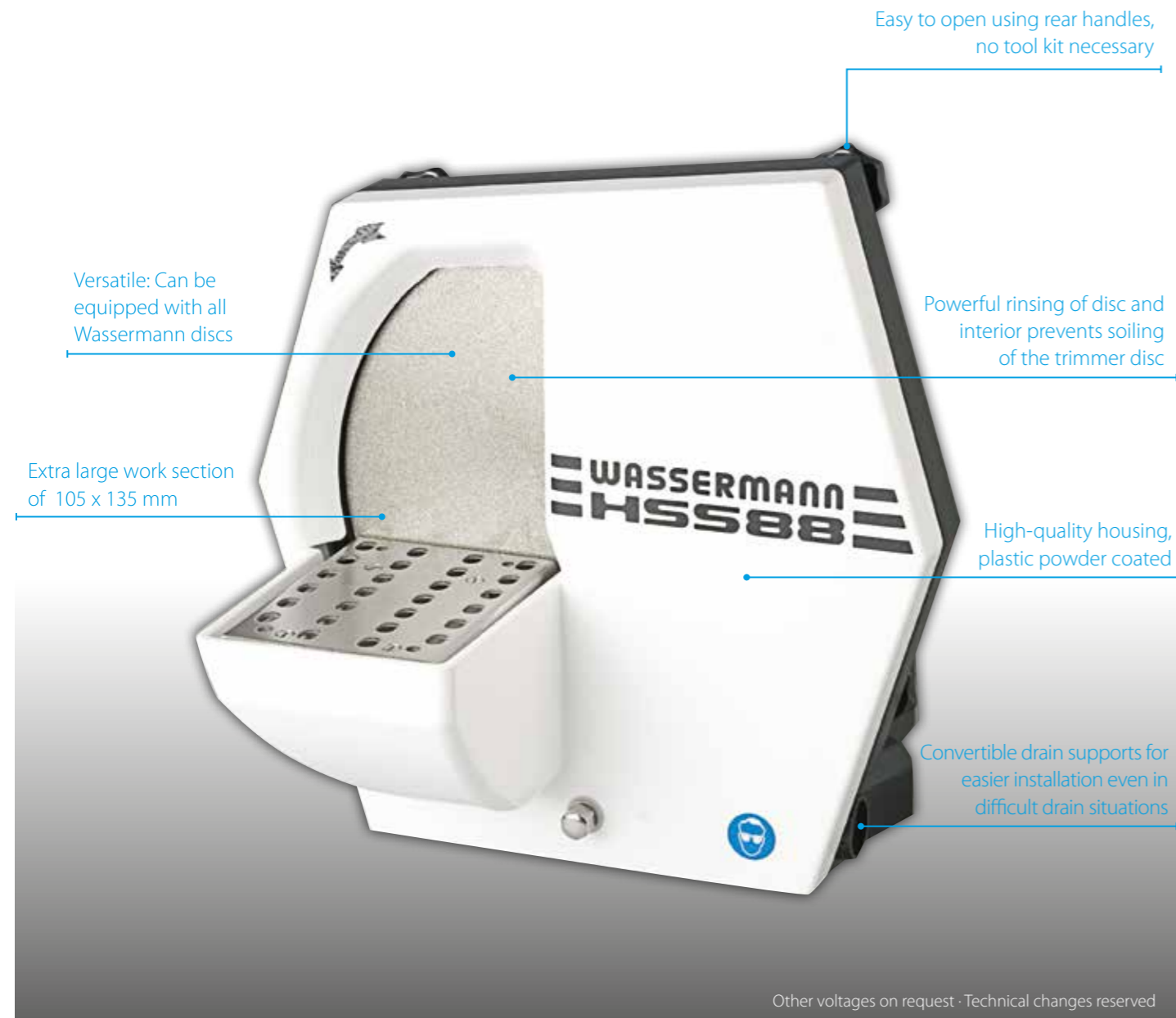

HSS-88 incl. grinding discs	Item no.
HSS-88 incl. diamond grinding disc	168998
HSS-88 incl. Dia-Quick grinding disc	168996
HSS-88 incl. corundum grinding disc	168999
HSS-88 incl. foil grinding disc	168991

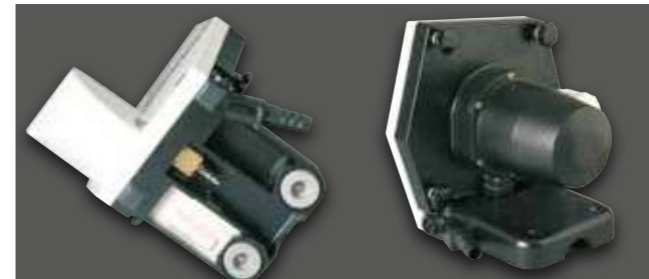

Extendable by orthodontic model table and/or laser light guide for 3 D trimming, ideal for orthodontics (the orthodontic model table can be delivered also in Swiss and EOS version).

Major Features

- Very powerful, maintenance-free motor, max. 3000 min⁻¹, splash protected according to IP 54
- Sturdy, oxidation-free bench with longitudinal slots and side openings – avoids water spills
- Supplied with solenoid valve for automatic water supply
- Multiple expansion options
- **Included in delivery:**
Inclined support
Supply hose, 1 m
Discharge hose, 1 m

Accessories	Item no.
Spare diamond grinding disc, incl. puller and grease	168063
Spare Dia-Quick grinding disc (partially diamond coated), incl. grease	162063
Spare corundum grinding disc, incl. puller and grease	168024
Spare foil grinding disc, 1 set = 4 pieces, incl. grease	162013
Spare foil grinding disc, fine, 1 set = 4 pieces, incl. grease	162023
Conversion kit, Dia-Quick and foil grinding disc	168071
Pressing tool to roughen corundum grinding disc	710001
Sealing grease for trimmer, 25 ml	629002
Puller for grinding disc change	164026

Orthodontic accessories for producing 3D orthodontic models

Orthodontic model table KMS according to Begg	168140
Laser light guide for model table, cpl.	168120
Orthodontic template for the upper jaw (to grind the lower jaw/tuber level)	164034

HSS-88 without grinding disc	Item no. 168997
Voltage	220–240 V / 50/60 Hz
Power consumption	4.6 A
Output	1000 W
W x H x D	330 x 335 x 410 mm
Weight	19.8 kg
Sound level	≤ 70 dB (A)
Speed	3000 min ⁻¹
Duty	S6–40 %
Table dimensions projecting	120 mm

Trimmer HSS-AZ & HSS-ZA

Perfect grinding in the smallest space: Whether it's the powerful **HSS-AZ** wet trimmer or the **HSS-ZA** combination trimmer with additional polishing spindle - excellent results guaranteed for dental models, thanks to their powerful motors and the almost wear- and maintenance-free technology used. The outer housing cools the motor so there is no risk of dirt entering. And of course both units are low-noise and vibration-free.

The foil grinding disc (usable on both sides) or the Dia-Quick grinding disc (partially diamond coated) could be used

Powerful rinsing of disc and interior prevents soiling of the trimmer disc

Sturdy, oxidation-free bench with longitudinal slots and side openings – avoids water spills

Easy to open using rear handles, no tool kit necessary

Splash-protected as per IP 54

High-quality housing, plastic powder coated



Other voltages on request · Technical changes reserved



HSS-AZ, rear side



HSS-ZA



HSS-ZA, in the rear with polishing spindle and convenient deposit table made of stainless steel



HSS-ZA, polishing trough with or without extractor nozzle, available as accessory



HSS-AZ/ -ZA, inclined support (removable)

Major Features

- Highest grinding and polishing speeds
HSS-AZ: 3000 min⁻¹, **HSS-ZA:** 2 settings, 1500 and 3000 min⁻¹
- **HSS-AZ:** Equipped as standard with solenoid valve for automatic water supply
- **Included in delivery:**
Inclined support
Supply hose, 1 m
Discharge hose, 1 m
Brush spindle left, 92 mm **HSS-ZA**

Accessories	Item no.
Spare Dia-Quick grinding disc (partially diamond coated), incl. grease	162063
Spare foil grinding disc, 1 set = 4 pieces, incl. grease	162013
Spare foil grinding disc, fine, 1 set = 4 pieces, incl. grease	162023
Sealing grease for trimmer, 25 ml	629002
Puller for grinding disc change	164026
Polishing trough* with extractor nozzle (Ø 75 mm) HSS-ZA	143115
Polishing trough* with extractor nozzle (Ø 40 mm) HSS-ZA	143131
Polishing trough* without extractor nozzle HSS-ZA	143123
Polishing trough base complete HSS-ZA	161115
Brush spindle left, 92 mm HSS-ZA	152025
Brush spindle left, 125 mm HSS-ZA	152044

* (W 207 x H 275 x D 292 mm)
(H depends on the adjustable safety screen)

HSS-AZ incl. Dia-Quick grinding disc	Item no. 162997
HSS-ZA incl. Dia-Quick grinding disc	Item no. 161996
HSS-AZ incl. foil grinding disc	Item no. 162996
HSS-ZA incl. foil grinding disc	Item no. 161997
Voltage	220–240 V / 50/60 Hz
Power consumption HSS-AZ, HSS-ZA	3.0 A, 3.5 A
Output	750 W
W x H x D HSS-AZ	290 x 320 x 380 mm
W x H x D / D incl. spindle HSS-ZA	300 x 315 x 480 / 525 mm
Spindle height HSS-ZA	170 mm
Weight incl. foil grinding disc HSS-AZ, HSS-ZA	19.2 kg, 19.6 kg
Sound level	≤ 70 dB (A)
Speed HSS-AZ, HSS-ZA	3000 min ⁻¹ , 1500 / 3000 min ⁻¹
Duty	S6–40 %
Table dimensions projecting	120 mm

Grinding Discs



Diamond Grinding Disc for HSS-99 and HSS-88

- Wassermann diamond coated discs make easy work of even the hardest plaster – minimal grinding pressure, maximum time saving
- Fully diamond coated for smooth surfaces model surfaces are always even despite the aggressive grinding power
- Rough and fine grinding in one process
- Extremely long service life – diamonds support each other over the whole surface, hence they cannot break off
- Excellent use for orthodontics

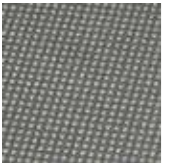

Dia-Quick Grinding Disc for HSS-88 and HSS-AZ/-ZA

- Partially diamond coated, island shape design
- Rapid results even with low grinding pressure
- Long service life
- Maximum safety due to electronically balanced supporting disc



Corundum Grinding Disc for HSS-88

- Approx. 10 mm thick silicon carbide coating
- Self-regenerating therefore constant and powerful grinding over a long period
- Complete surface glued to supporting disc for maximum safety
- Electronically balanced, therefore no vibration



Foil Grinding Disc for HSS-88 and HSS-AZ/-ZA

- Silicon carbide coating – usable on both sides
- Flexible, stable design
- Electronically balanced supporting disc
- Disc not glued to supporting disc, hence easily to be replaced
- Fast and easy replacement of worn discs



Wassermann discs set standards. Available for every plaster hardness and offering the user top quality to meet the highest demands. From the versatile foil grinding disc to Wassermann's own diamond grinding discs – our experience is your benefit.

Major Features

Included in delivery:

Sets of spare grinding discs	Item no.
Spare diamond grinding disc for HSS-99, fully diamond coated, incl. sealing grease and puller for grinding disc change	164063
Spare diamond grinding disc for HSS-88, fully diamond coated, incl. sealing grease and puller for grinding disc change	168063
Spare Dia-Quick grinding disc for HSS-88, HSS-AZ, HSS-ZA, partially diamond coated, incl. sealing grease	162063
Spare corundum grinding disc for HSS-88, 10 mm thick, incl. sealing grease and puller for grinding disc change	168024
Spare foil grinding disc for HSS-88, HSS-AZ, HSS-ZA, 1 set = 4 pieces, incl. sealing grease	162013
Spare foil grinding disc, fine, for HSS-88, HSS-AZ, HSS-ZA, 1 set = 4 pieces, incl. sealing grease	162023
Conversion kit for HSS-88 for Dia-Quick- and foil grinding disc, incl. sealing grease and puller for grinding disc change	168071

Trimmer incl. Grinding Discs



HSS-99, with diamond grinding disc and orthodontic accessories

Device alternatives	Item no.
HSS-99 incl. diamond grinding disc	164998
HSS-88 incl. diamond grinding disc	168998
HSS-88 incl. Dia-Quick grinding disc (partially diamond coated)	168996
HSS-88 incl. corundum grinding disc	168999
HSS-88 incl. foil grinding disc	168991
HSS-AZ incl. Dia-Quick grinding disc (partially diamond coated)	162997
HSS-AZ incl. foil grinding disc	162996
HSS-ZA incl. Dia-Quick grinding disc (partially diamond coated)	161996
HSS-ZA incl. foil grinding disc	161997



HSS-88, can be equipped with all Wassermann discs



HSS-AZ, designed for perfect grinding in the dental clinics



HSS-ZA, in the rear with polishing spindle



ISO-certified
quality management system

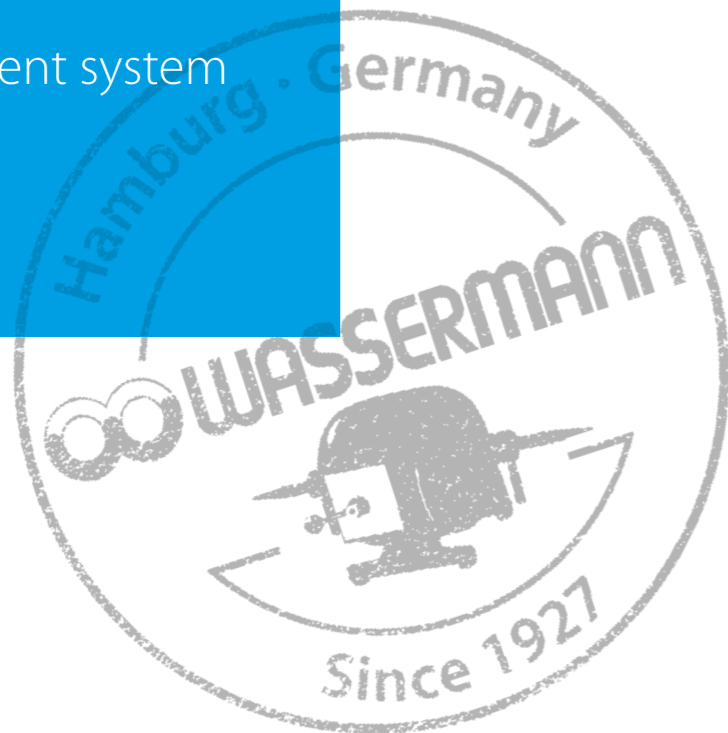

Steam Cleaner Wasi-Steam Compact

The powerful **Wasi-Steam Compact** is a reliable steam cleaner with a wide range of application. This steam cleaner is one of the most powerful units on the market. Thorough and efficient it is suitable for all cleaning jobs in the lab. Its high cleaning pressure of up to 6 bar also guarantees a high cleaning temperature.

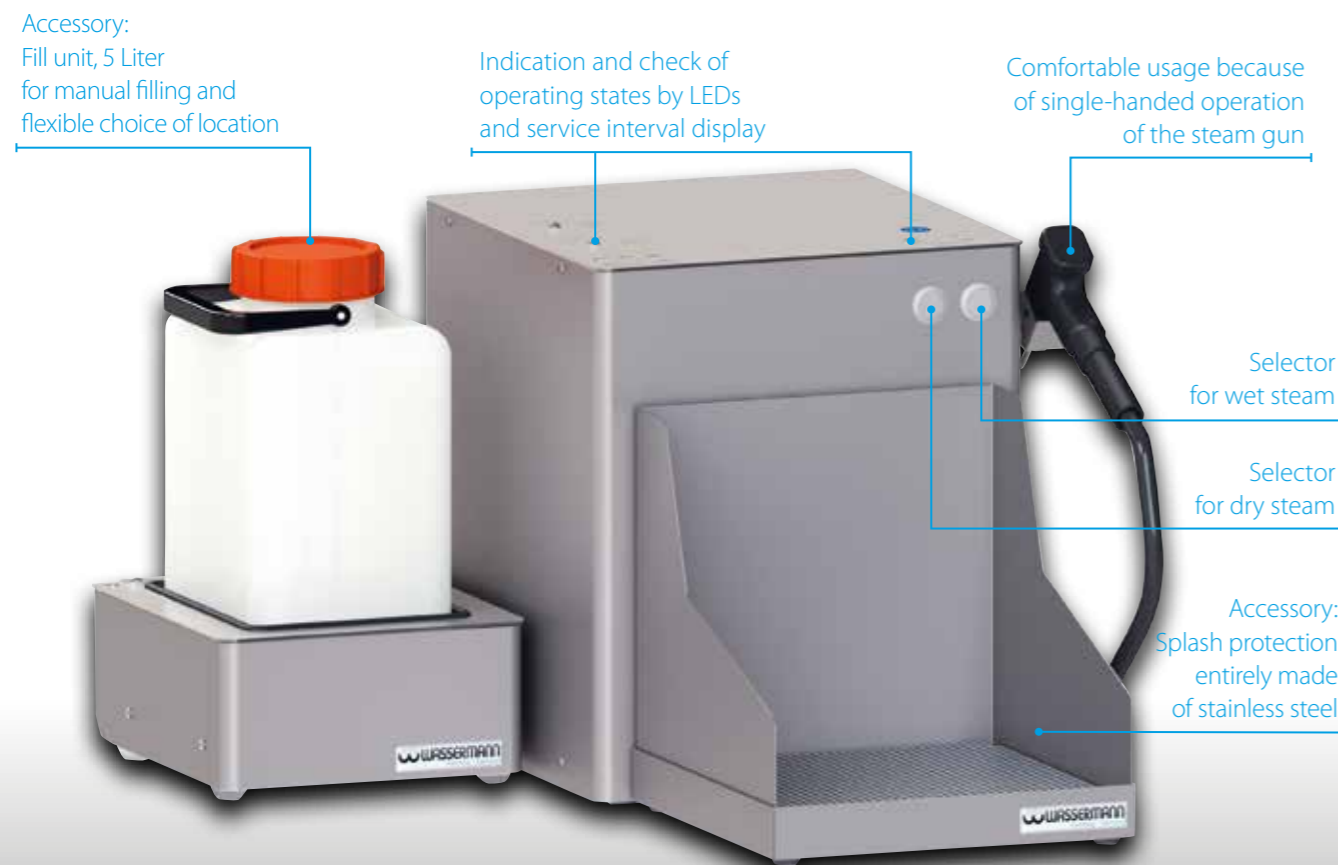

Other voltages on request · Technical changes reserved

Major Features

- Stainless steel housing and boiler
- Simple operation, high safety standards
- Protects seals by reducing pressure to 5 bar after 10-minute break
- Basic version: Tabletop unit, permanent water supply
- Available as accessory: Fill unit (5 Liter) for manual filling and flexible choice of location
- Available on request: Version with wet steam regulation and steam quantity saturation
- **Included in delivery:**
Supply hose, grey, cpl., 1.3 m
Discharge hose, 1.5 m
Hose clip Ø 12-20 x 9



Wasi-Steam Compact, version with accessory, to regulate wet steam saturation and steam quantity



Wasi-Clean water softener, available as accessory. Strongly recommend for labs without a decalcification plant. To prevent the formation of limescale deposits caused by water hardness. Reduced maintenance costs, long service life and reliable operation.



Accessory: Fill unit (5 Liter) for manual filling and flexible choice of location, operation with distilled/ softened water is possible and recommended



Accessory: Fill unit (5 Liter) for manual filling and flexible choice of location, operation with distilled/ softened water is possible and recommended

Accessories	Item no.
Wasi-Clean water softener, table top unit W 190 x H 405 x D 260 mm (This accessory is strongly recommended and hence available in a bundle with 174994 Wasi-Steam Compact.)	174995
Splash protection, stainless steel W 250 x H 265 x D 255 mm	174460
Fill unit (5 Liter) (W 215 x H 340 x D 240 mm, D + connection = 290 mm)	174430
Quantity Control Accessory Set to regulate wet steam saturation and steam quantity (It would require to retrofit the unit at our factory or at one of our authorized service stations.)	174414
Special nozzle Ø 2.5 mm (Basic nozzle Ø 1.2 mm, item no. 174100)	174352
Drain hose per meter	320031
Wasi-Steam Compact stainless steel	Item no. 174994 #CCVA#
Wasi-Steam Compact stainless steel white	Item no. 174994 #CCWH#
Voltage	220–240 V / 50/60 Hz
Power consumption	5.5 A (6.3 A medium-blowing-fuse)
Output	1270 W
W x H x D max.	345 x 360 x 390 mm
W x H x D (housing)	300 x 353 x 310 mm
Weight	19 kg
Noise level	≤ 70 dB (A)
Working pressure	max. 6 bar (stand by 5 bar)
Steam temperature	max. 164°C at 6 bar
Boiler capacity	3.3 l
Safety class	IP 22
Duty	Interrupt operation 5/5 min

Steam Cleaner **Wasi-Steam Classic II**

Compact format, strong performance: The **Wasi-Steam classic** is the perfect solution when there is little space and big demand. With its variable work pressure of up to 5 bar it offers in particular the multistation user a gentle but quick and thorough cleaning of all small parts.

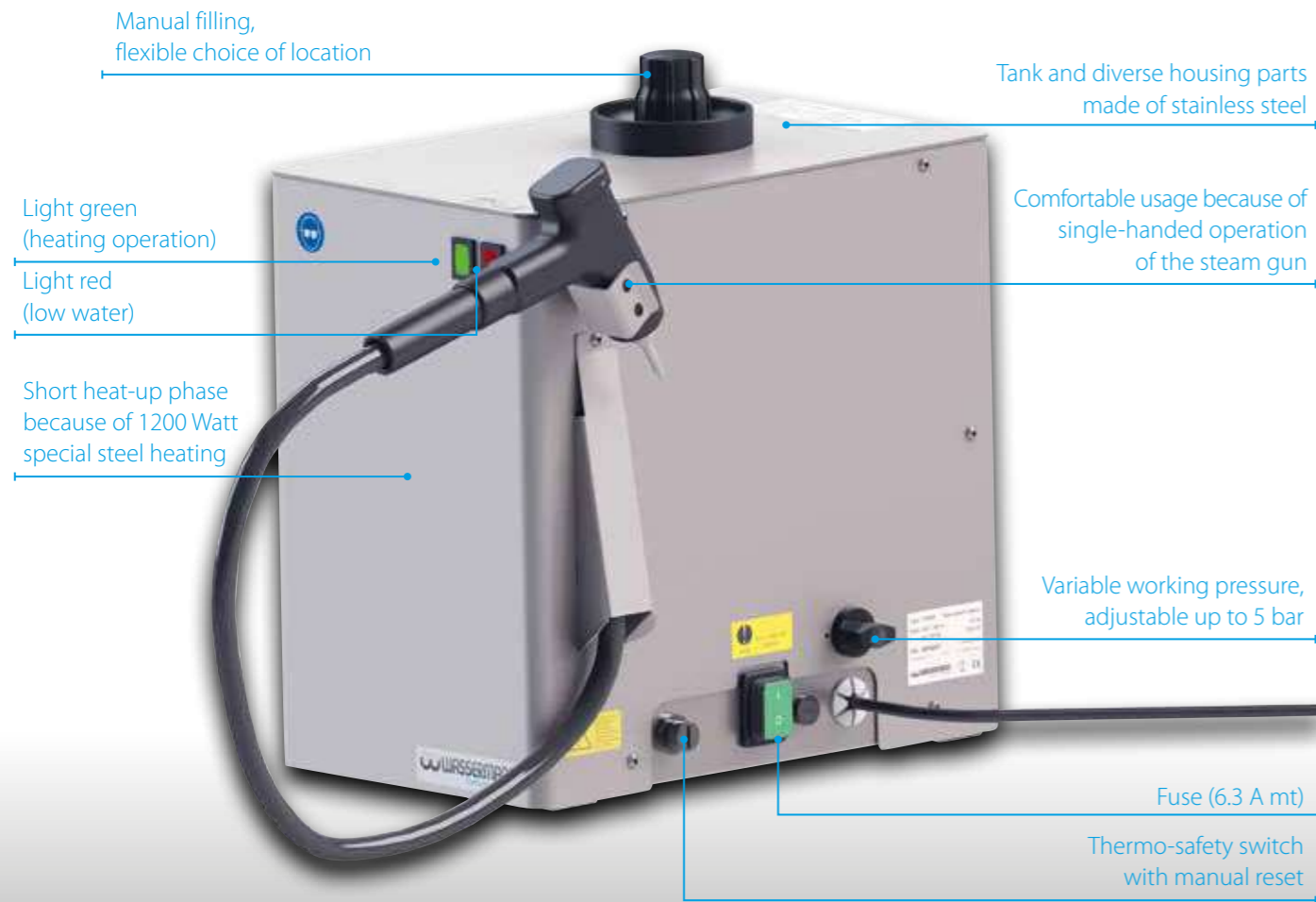

Other voltages on request · Technical changes reserved



Steam gun



Available as accessory: Splash protection entirely made of stainless steel, open at the front and top, easy to clean component parts (splash protection, basement, strainer insert)



Available as accessory: Stainless steel splash protection with fixed hood (chimney effect), easy to clean component parts (splash protection, strainerinsert, plastic basement)

Major Features

- Perfect for use with limited space
- Short heat-up phase because of 1200 Watt-special steel heating
- Gentle and quick to use, thorough results
- High safety because of protection against dry running
- Wall mounting possible, fastening set for wall mounting available as accessory

Accessories	Item no.
Splash protection entirely made of stainless steel W 250 x H 265 x D 255 mm, open at the front and top	174460
Splash protection, stainless steel, plastic basement W 235 x H 385 x D 294 mm, with fixed stainless steel hood	174360
Fastening set for wall mounting	174358
1 L lime remover	655002
Special nozzle Ø 2.5 mm (Spare basic nozzle Ø 1.2 mm, item no. 174100)	174352

Wasi-Steam Classic II stainless steel	Item no. 174996 #CCVA#
Wasi-Steam Classic II stainless steel white	Item no. 174996#CCWH#
Voltage	220–240 V / 50/60 Hz
Power consumption	5.3 A (6.3 A medium-blowing-fuse)
Output	1220 W
W x H x D max. W x H x D (housing)	245 x 350 x 315 mm 200 x 305 x 310 mm
Weight	12.5 kg
Sound level	≤ 70 dB (A)
Working pressure	max. 5 bar
Steam temperature	approx. 158 °C (at 5 bar)
Boiler capacity	3.3 l
Safety class	IP 22



Wasi-Steam Classic II stainless steel



Wasi-Steam Classic II stainless steel white

Boil Out Unit **Wapo-Ex 12 II**

The boil out unit **Wapo-Ex 12 II** stands out thanks to its efficient applications planning, programmable timer and automatic wax removal. This free standing unit with integrated spray gallows scalds up to 12 flask halves simultaneously and fully automatically. A touch screen offers diverse functions and reproducible procedures by simple programming. An elaborate boil out unit manufactured using high quality materials and components and designed for durability.



Other voltages on request · Technical changes reserved

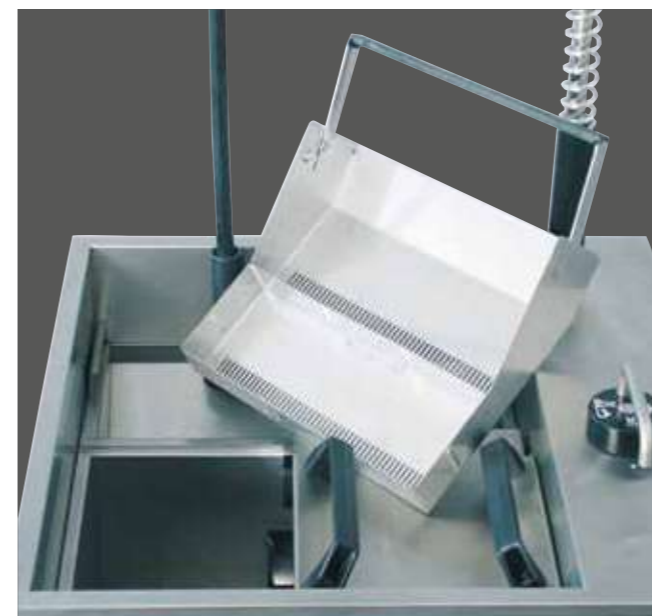
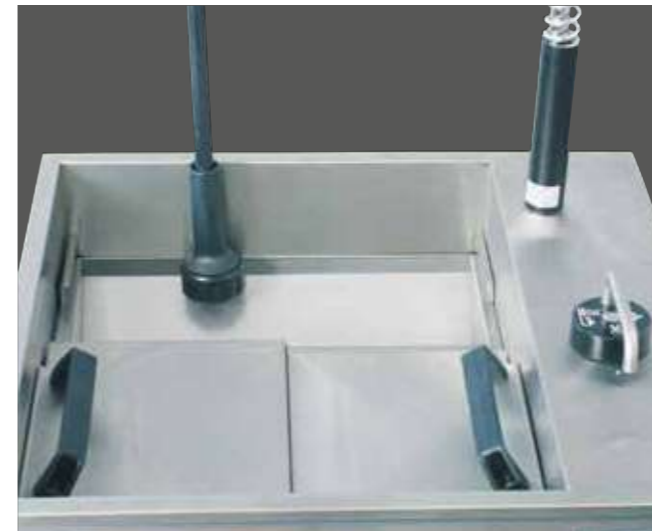

Major Features

- Free standing unit for scalding up to 12 flask halves
- Efficient usage thanks to its programmable timer and automatic wax removal
- Safety features with visual and audible signals, e.g. electronic water level gauge, leakage warning signal and inlet limitation
- Energy saving because of the intelligent heating control
- **Included in delivery:**
 - Spray gallows
 - Service set (1 L lime remover and 2 L wax remover)
 - Supply hose with water inlet valve and gasket, 2 m
 - Discharge hose with hose clip Ø 12-20 x 9, 2.5 m
 - Spray arm tube with seal
 - 2 flask baskets
 - 2 covers

Accessories	Item no.
Service set (1 L lime remover and 2 L wax remover)	170330
Wapo-Ex 12 II	Item no. 170970
Voltage	220–240 V / 50/60 Hz
Power consumption	12 A
Output	max. 3300 W
W x H (without spray gallows) x D	650 x 900 x 620 mm
W x H (with spray gallows) x D	650 x 1600 x 620 mm
Weight	87 kg
Sound level	≤ 70 dB (A)
Water capacity	approx. 50 l
Water feed rate	4.5 l / min
Water drain height	470 mm

Combination Automat Wapo-Ex 8 Plus

Boil Out and Polymerisation Unit

The **Wapo-Ex 8 Plus** enables the automatic boil out of up to 8 flask halves, simultaneously and fully automatically. The relevant parameters are at once visible on the touch screen, the input can be made intuitively. The user can adjust the numerous parameters and options (such as week timer) to his individual requirements by simple programming.



Other voltages on request · Technical changes reserved



Hand spray for manual scalding



Convenient boil out process, easy access to flask baskets



Reliable polymerisation results

Major Features

- Compact tabletop automat for boil out up to 8 flask halves or polymerisation up to 8 flasks in a clamp
- Thermostat protected, gasketless submersible pump, maintenance-free
- Spray system in the middle, easy to mount/ dismount
- Quick exchange of both functions boil-out and polymerisation
- Optical and acoustic lack of water warning
- Easy to clean without tools
- **Included in delivery:**
Service set
(4 filter mats, 1 L lime remover, 2 L wax remover)
Discharge hose, 1.5 m
Hose clip Ø 20-32 x 12.2

Accessories	Item no.
Mobile stand (W 620 x H 550 x D 430 mm)	170120
Service set (4 filter mats, 1 L lime remover, 2 L wax remover)	170021
Discharge hose per meter	320030

Wapo-Ex 8 Plus	Item no. 170977
Voltage	220-240 V / 50/60 Hz
Power consumption	9 A
Output	2000 W
W x H x D max.	660 x 585 x 480 mm
W x H x D (housing)	615 x 550 x 425 mm
Weight	41 kg
Sound level	≤ 70 dB (A)
Water capacity	21 l

Polymerisation Unit Wapo-Mat III

The water bath of the **Wapo-Mat III** can be used for long-time and boiling polymerisation of all common plastics. The user set the relevant parameters quickly and easily using self-explanatory symbols. The option of 3 temperatures and 3 times is possible, with remaining time reading. The factory setting is that the main polymerization process will start automatically at 95 °C 90 minutes before the program ends.

Process up to 9 flasks in a flask holder at one time

Energy saving thermal insulation

Touch screen for fast and easy operation



Other voltages on request · Technical changes reserved



Major Features

- Compact benchtop automat with fully automatic program sequence
- Powerful, electronically controlled heater for optimal water temperature and long service life of the electrical components
- Low water level indicated visually and audibly
- Low maintenance, easy to clean
- **Included in delivery:**
 - 1 L lime remover
 - Discharge hose, 1.5 m
 - Hose clip Ø 20-32 x 12.2

Accessories	Item no.
1 L lime remover	655002
Discharge hose per meter	320030

Wapo-Mat III	Item no. 170980
Voltage	220–240 V / 50/60 Hz
Power consumption	8 A
Output	1800 W
W x H x D	330 x 460 x 530 mm
Weight	18.5 kg
Sound level	≤ 70 dB (A)
Water capacity	18.5 l

Combination Automat Polyquick 260-T105

Pressure Polymerisation Unit and Compactor

The Polyquick 260-T105 is a pressure polymerisation unit for hot and cold polymerisation of plastics. It can be set to a maximum temperature of 105 °C and the polymerisation pressure can be adjusted to a maximum of 4 bar. In automatic mode, the polymerisation time can be preselected up to 99 hours. It has a particularly large pressure pot volume and can hence also accommodate extra large articulators or up to 6 brass flasks including clamp. A touch screen and the newly developed control panel allow the user to set the relevant parameters quickly and easily using self-explanatory symbols. The Polyquick 260-T105 can also be used as a pressure compactor without heating.



Other voltages on request · Technical changes reserved



Polyquick 260-T105, also suitable for extra large articulators



Self-explanatory symbols, fast and easy operation

Major Features

- Compact table-top unit for pressure polymerisation up to 105°C in a water bath
- 13 programmes, each with three individually configurable polymerisation stages
- The automat can also be operated as a pressure compactor
- Rapid draining: Prompt switch between the two modes
- Separate menu for each mode
- Intelligent workflow preset by the software helps the user to ensure operational safety
- Remaining time displayed to the second
- Powerful, electronically regulated heating for optimal water temperature
- Very large capacity Ø 240 mm, usable depth 160 mm
- Pressure relief valve for protection in case of malfunction (7 bar)
- Engraving in container indicating max. water level
- Time and cost saving due to thermal insulation
- Low maintenance, easy to service
- **Included in delivery:**
Flask bracket support
Compressed air hose, 2 m
Discharge hose, 2 m
Hose clip Ø 12-20 x 9

Accessories	Item no.
Flask bracket support	170414
Compressed air hose per meter	320026
Discharge hose per meter	320031
On request: flask basket as special accessory	-----

Polyquick 260-T105	Item no. 170993
Voltage	220-240 V / 50/60 Hz
Power consumption	4.3 A
Output	1100 W
W x H x D	420 x 450 (open=490) x 510 (+20 for air socket) mm
Weight	41 kg
Sound level	≤ 70 dB (A)
Compressed air connection	min. 2 bar
Operating pressure	max. 4 bar (limiting at 20°C)
Pressure chamber	Ø 240 mm, depth 175 mm (usable depth 160 mm)

Combination Automat Polyquick 160-T95

Pressure Polymerisation Unit and Compactor

The **Polyquick 160-T95** is a pressure polymerisation unit for hot and cold polymerisation of plastics. This automat is designed for polymerisation of up to 3 flasks in flask holder or 2 cast resin flasks or rebasing frames or 6 orthodontic regulatings at one time. In automatic mode, the polymerisation time can be preselected up to 99 hours. A touch screen and the newly developed control panel allow the user to set the relevant parameters quickly and easily using self-explanatory symbols. The Polyquick 160-T95 can also be used as a pressure compactor without heating.



Other voltages on request · Technical changes reserved



Self-explanatory symbols, fast and easy operation

Major Features

- Compact table-top unit for pressure polymerisation up to 95°C in a water bath
- The polymerisation pressure can be adjusted to a maximum of 6 bar
- 13 programmes, each with three individually configurable polymerisation stages
- The automat can also be operated as a pressure compactor
- Rapid draining: Prompt switch between the two modes
- Separate menu for each mode
- Intelligent workflow preset by the software helps the user to ensure operational safety
- Pressure relief valve for protection in case of malfunction (7 bar)
- Dry-run protection
- Engraving in container indicating max. water level
- **Incl. in delivery:**
 - Flask bracket support
 - Flask basket
 - Compressed air hose, 2 m
 - Discharge hose, 2 m
 - Hose clip Ø 12-20 x 9

Accessories	Item no.
Flask bracket support	170508
Flask basket	170499
Compressed air hose per meter	320026
Discharge hose per meter	320031

Polyquick 160-T95	Item no. 170976
Voltage	220-240 V / 50/60 Hz
Power consumption	4.2 A
Output	1000 W
W x H x D	325 x 435 x 375 mm
Weight	22 kg
Sound level	≤ 70 dB (A)
Compressed air connection	min. 2 bar
Operating pressure	max. 6 bar
Pressure	Ø 150 mm, T 285 mm

Compactors DEG-2 & DEG-1

The DEG-2 and DEG-1 high-power compactors for hardening embedding and silicone duplicating materials compress the residual air completely so they create a dense, homogeneous product. Depending on the inlet pressure, up to 6.0 bar can be achieved and afterwards be reduced as desired. Both devices are designed to take several muffles at the same time.



Other voltages on request · Technical changes reserved



DEG-2, rotatable door with quick fastener



DEG-2 with polymerisation trough, available as accessory



DEG-1



DEG-1, rotatable door with quick fastener

Major Features

- For a dense, homogeneous structure and smooth rough castings
- Integrated stainless steel plates, designed for multiple muffles
- Pressure control valve for maximum safety
- Non-return valve for steady operating pressure
- Automatic venting: After the set time has expired, the pressure chamber will vent automatically
- **Incl. in delivery:**
Compressed air hose, 2 m
Supply line

Accessories	Item no.
Compressed air hose per meter	320026
Polymerisation trough DEG-2	180053

DEG-2 DEG-1	Item no. 180996 Item no. 180999
Voltage	220–240 V / 50/60 Hz
Power consumption DEG-2	4.2 A
Power consumption DEG-1	0.1 A
Output DEG-2	1000 W
Output DEG-1	20 W
W x H x D DEG-2	345 x 285 x 450 mm
W x H x D DEG-1	300 x 230 x 380 mm
Weight DEG-2	19.7 kg
Weight DEG-1	13.2 kg
Sound level	≤ 70 dB (A)
Compressed air connection	min. 3.5 bar
Operating pressure	max. 6 bar
Pressure chamber H x D DEG-2	130 x 285 mm
Pressure chamber H x D DEG-1	130 x 250 mm

Dosing and Mixing Unit **Sidomix II**

The **Sidomix II** is a dosing and mixing unit for addition-vulcanizing duplicating silicones of low viscosity. A regulable bypass circuit ensures an optimum mixing ratio. The mixing ratio can be adjusted very easily and quickly by the user with the help of a convenient quantity flow control. The desired components are mixed 1:1 and dosed correctly – automatically, totally homogenous and fully bubble-free.

Major Features

- **Included in delivery:**
Set material cask with quick fitting coupling, 2 x 2 liter
Mixing canulas, pink, 10 pcs.

We recommend the use of our duplicating silicones, 1:1. Available as:

- 1 kg, component A / B
- 6 kg, component A / B
- 25 kg, component A / B



WaSil soft, 6 kg cask, hardness Shore A: 16-18



WaSil speed, 6 kg cask, hardness Shore A: > 24

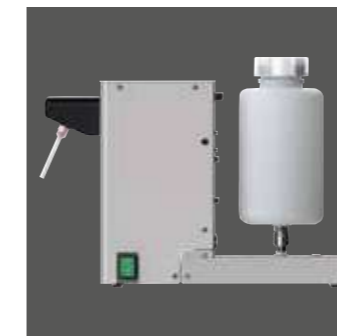

Convenient: The containers for the A and B components can be fitted very easy to the unit by the quick couplings, Adapter-sets for various cask sizes are available as accessories



The mixing head with separate outlets makes mixing of components impossible – even when attaching and removing the mixing cannulas

Material and time saving with loss-free filling of several flasks with one mixing cannula

High quality construction, made of stainless steel

Accessories	Item no.
Set material cask with quick fitting coupling, 2 x 2 liter	172640
Stand small for duplicating silicones, 2 x 6 kg-cask	172631
Stand tall for duplicating silicones, 2 x 25 kg-cask	172632
Connecting tubes cpl., 2 pcs.	172633
Adapter-set for duplicating silicones, 2 x 1 kg-cask	172634
Adapter-set for duplicating silicones, 2 x 6 kg-cask	172636
Mixing canulas 1:1, inner Ø 5.4 mm, pink, 100 pieces	622002
Consumable materials	
Duplicating silicone, 1:1	
WaSil soft, hardness Shore A: 16-18, 2 x 1 kg, component A / B	656060
WaSil soft, hardness Shore A: 16-18, 2 x 6 kg, component A / B	656061
WaSil soft, hardness Shore A: 16-18, 2 x 25 kg, component A / B	656062
WaSil speed, hardness Shore A: > 24, 2 x 1 kg, component A / B	656070
WaSil speed, hardness Shore A: > 24, 2 x 6 kg, component A / B	656071
WaSil speed, hardness Shore A: > 24, 2 x 25 kg, component A / B	656072

Sidomix II	Item no. 172980
Voltage	220–240 V / 50/60 Hz
Power consumption	1.6 A
Output	260 W
W x H x D max.	275 x 340 x 440 mm
W x H x D (housing)	242 x 305 x 360 mm
Weight	11.5 kg
Sound level	≤ 70 dB (A)



Single-handed operation

Other voltages on request · Technical changes reserved

Hydraulic Press WW-33

The WW-33 is designed for daily use. It has a working pressure that can be adjusted up to 6 tonnes – for the appropriate pressing of 1–3 or 2–4 flasks. It works efficiently thanks to the valve which can be opened to allow the piston to return to its starting position automatically – hence the press is ready again for operation without losing time.



Other voltages on request · Technical changes reserved

Major Features

- Break-proof hydraulic press in drawn steel for pressing 1–3 or 2–4 flasks
- Distance of columns of 152 mm to allow use of larger flasks and flask clamps
- Plastic powder coated housing
- High stability
- **Included in delivery:**
WW-33 for 2-4 or 1-3 flasks
Pump lever

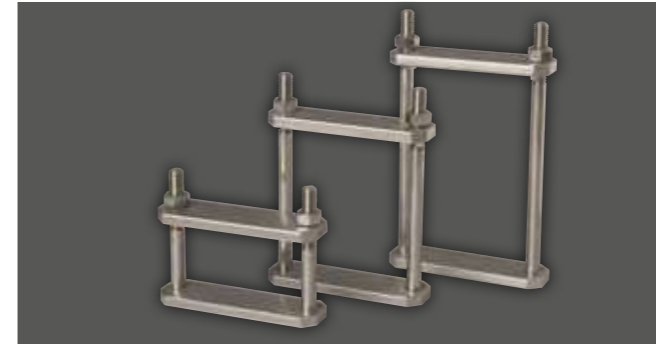

Stainless steel clamp clips



Universal flask clamps



WW-33, version for 1-3 flasks

Accessories	Item no.
Universal flask	129990
Stainless steel clamp clip for 3 flasks	129992
Stainless steel clamp clip for 2 flasks	129993
Stainless steel clamp clip for 1 flask	129994
Universal flask clamp for 3 flasks	129995
Universal flask clamp for 2 flasks	129996
Universal flask clamp for 1 flask	129997
Hydraulic oil 500 ccm	629005

WW-33, 2–4 flasks	Item no. 126998
WW-33, 1–3 flasks	Item no. 126999
W x D / D with pump lever	200 x 158 / 295 mm
Height WW-33, 2–4 flasks	max. 710 / min. 540 mm
Height WW-33, 1–3 flasks	max. 650 / min. 480 mm
Distance between columns	152 mm
Distance plunger plate WW-33, 2–4 flasks	max. 272 / min. 102 mm
Distance plunger plate WW-33, 1–3 flasks	max. 212 / min. 42 mm
Weight WW-33, 2–4 flasks	16.0 kg
Weight WW-33, 1–3 flasks	14.7 kg
Working pressure	up to 6 tons
Working table	Ø 95 mm

Ejection Press APR-1

With the APR-1 deflashing of cast rings works: Using only little power by just pushing down the lever, almost dust-free and entirely safe. Due to the even and centered pressure from above the castings come out undamaged and hence are fit for long term use.

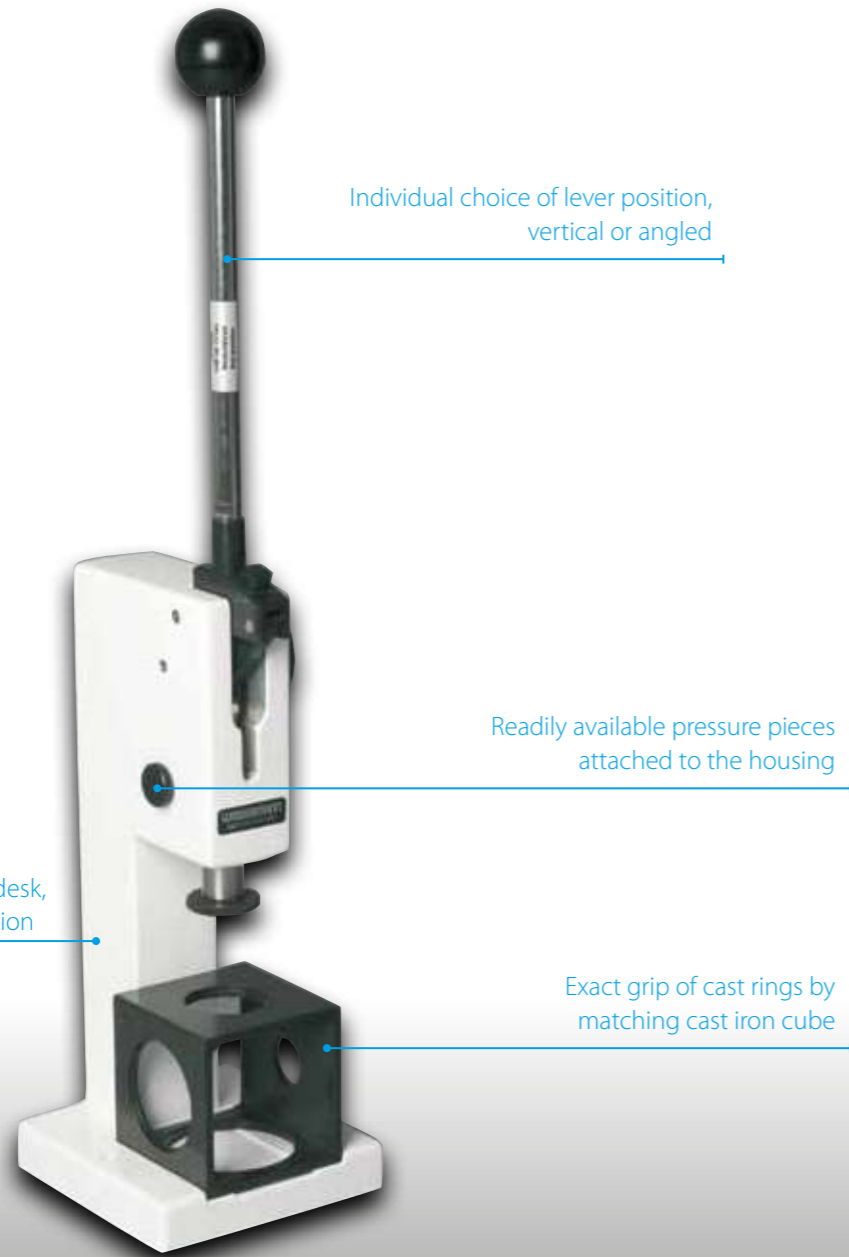

Individual choice of lever position, vertical or angled

Readily available pressure pieces attached to the housing

The APR-1 can be screwed to desk, wall mount available as an option

Exact grip of cast rings by matching cast iron cube

Other voltages on request · Technical changes reserved

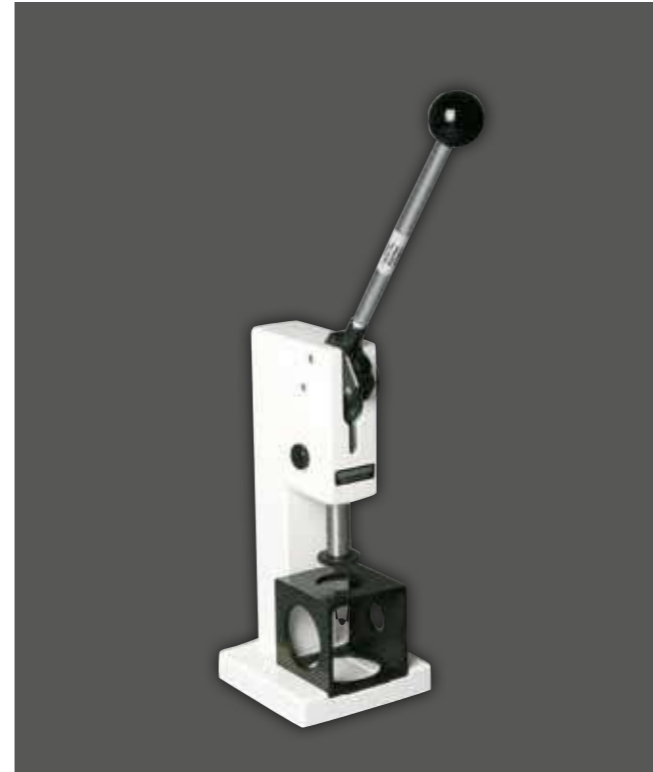
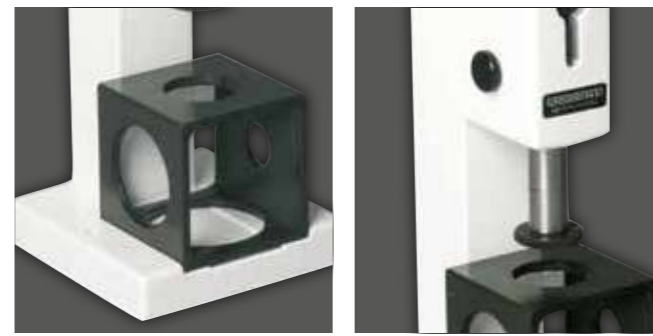

Major Features

- **Included in delivery:**
 Cube for cast rings / cast flasks (DeguDent / Heraeus Kulzer)
 Pressure piece Ø 26
 Pressure piece Ø 43
 Pressure piece Ø 60
 Pressure piece Ø 75

Accessories	Item no.
Wall mount	128100
APR-1	
Item no.	128999
W x H x D	160 x 380 x 160 mm
Height with handle	670 mm
Weight	13.8 kg
Cube size	97 x 97 x 97 mm



Production is in Hamburg,
delivery is to the whole world

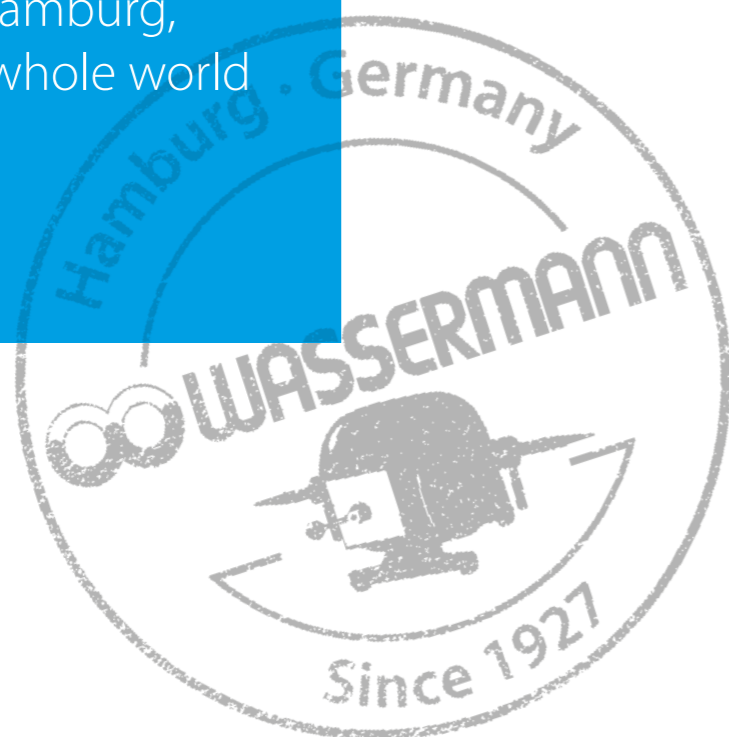

Fine Blasting Units **Cemat-4 II, Cemat-3 II & Cemat-2 II**

First-class work results are guaranteed by using the precision fine blasting units of the **Cemat series**. These fine blasting specialists equipped with either 2 to 4 full metal blasting material tanks combine everything that can be desired of an unit of this quality - highest comfort included! Whether sand-blasting, roughening or polishing: Details such as the colour coding system or the optimum workspace illumination by a protected fluorescent lamp make it easy to work. The entire system is under pressure constantly and is ready for operation immediately. The unit operate extra accurately and convenient thanks to the individually adjustable pressure control per chamber.

We recommend the use of Wassermann blasting materials and our low-pressure suction units **SG-10, SG-1/1** and **SG-1/2 D**. PVC-hose Ø 75 mm, various lengths available, see page 78 Accessories for suction technology

Factory pre-set pressure reducer

Rapid ventilation of the high quality blasting material containers made of metal for rapid re-filling and changing of blasting material

Individually adjustable pressure control per chamber: Steady pulse-free blast of 0.8-6 bar

Easy choice of the desired blasting material by using the selection switch for colour circuit settings

With plug socket, e.g. for a suction unit

Air inlet membrane: If needed cut in the rubber vertically and horizontally to achieve an optimum exhaust air stream into the vent of the connected suction unit

Permanent pressure system: Prevents contamination and moisture of blasting material

Optimum workspace illumination, protected LED lamp

Flow rate control: Adjustable blasting material consumption

Sand drawer for catching coarse of materials to relieve filters



Other voltages on request · Technical changes reserved



Chambers with individual working pressure, 0.8–6 bar



Ergonomically shaped handpieces and a separate air blasting nozzle



Cemat-3 II



Cemat-2 II

Major Features

- Extra efficient, comfortable and flexible: Multifunctional fine blasting units with 2 to 4 chambers
- With handy air blasting nozzle for easy cleaning
- Genuine quick start/stop function, foot-controlled
- Comfortably to handle with ergonomically shaped handpieces
- Cost savings thanks to noticeable low consumption of blasting material
- High hygiene standard because of changeable sleeves
- Special particularly durable hoses
- Convenient colour coding system
- Specially coated safety screen for ideal visibility
- Simple cleaning due to stay-clean surfaces: High quality stainless steel and robust plastic powder coating
- **Included in delivery:**
 - Compressed air hose, 2 m
 - 592012 Supply line 3 core with angle plug (Delivered only on request: 592011 Supply line 3 core US 13 A)
 - Cemat-4 II** incl. 4 fine blasting nozzles: 0.6 (yellow), 0.8 (blue), 1.2 (red), 0.8 (green)
 - Cemat-3 II** incl. 3 fine blasting nozzles: 0.8 (blue), 1.2 (red), 0.8 (green)
 - Cemat-2 II** incl. 2 fine blasting nozzles: 0.8 (blue), 1.2 (red)

Accessories

Accessories	Item no.
Extractor nozzle Ø 40 mm exterior	143385
Extractor nozzle Ø 50 mm exterior	190286
Compressed air hose per meter	320026
Spare fine blasting nozzle 0.6 mm	190550
Spare fine blasting nozzle 0.8 mm	190551
Spare fine blasting nozzle 1.2 mm	190552

Cemat-4 II	Item no. 190984
Cemat-3 II	Item no. 190983
Cemat-2 II	Item no. 190982

Voltage	100–240 V / 50/60 Hz
Power consumption	0.2 A
Plug socket power consumption	max. 8 A
Output	50 W
W x H x D	445 x 460 x 620 mm
Weight Cemat-4 II/ -3 II/ -2 II	28 kg/ 26 kg/ 24 kg
Sound level	≤ 70 dB (A)
Tank capacity	560 cm ³
Compressed air connection	3–6 bar
Working pressure	0.8–6 bar
Extractor nozzle	Ø 75 mm exterior

Fine Blasting Units **Gobi Comfort-4, Gobi Comfort-3 & Gobi Comfort-2**

Whether sand-blasting, roughening or polishing: First-class work results are guaranteed by using the precision fine blasting units of the **Gobi Comfort series**. These fine blasting specialists equipped with either 2 to 4 full metal blasting material tanks offer unique features in its class. The entire system is continuously under pressure and is therefore always ready for use. Even when switching on the unit again, you can use the quick start- and quick stop function to begin blasting immediately. This is possible due to the crushing valve at the conducting hose.

We recommend the use of Wassermann blasting materials and our low-pressure suction units **SG-10, SG-1/1 and SG-1/2 D**. PVC-hose Ø 75 mm, various lengths available, see page 78 Accessories for suction technology

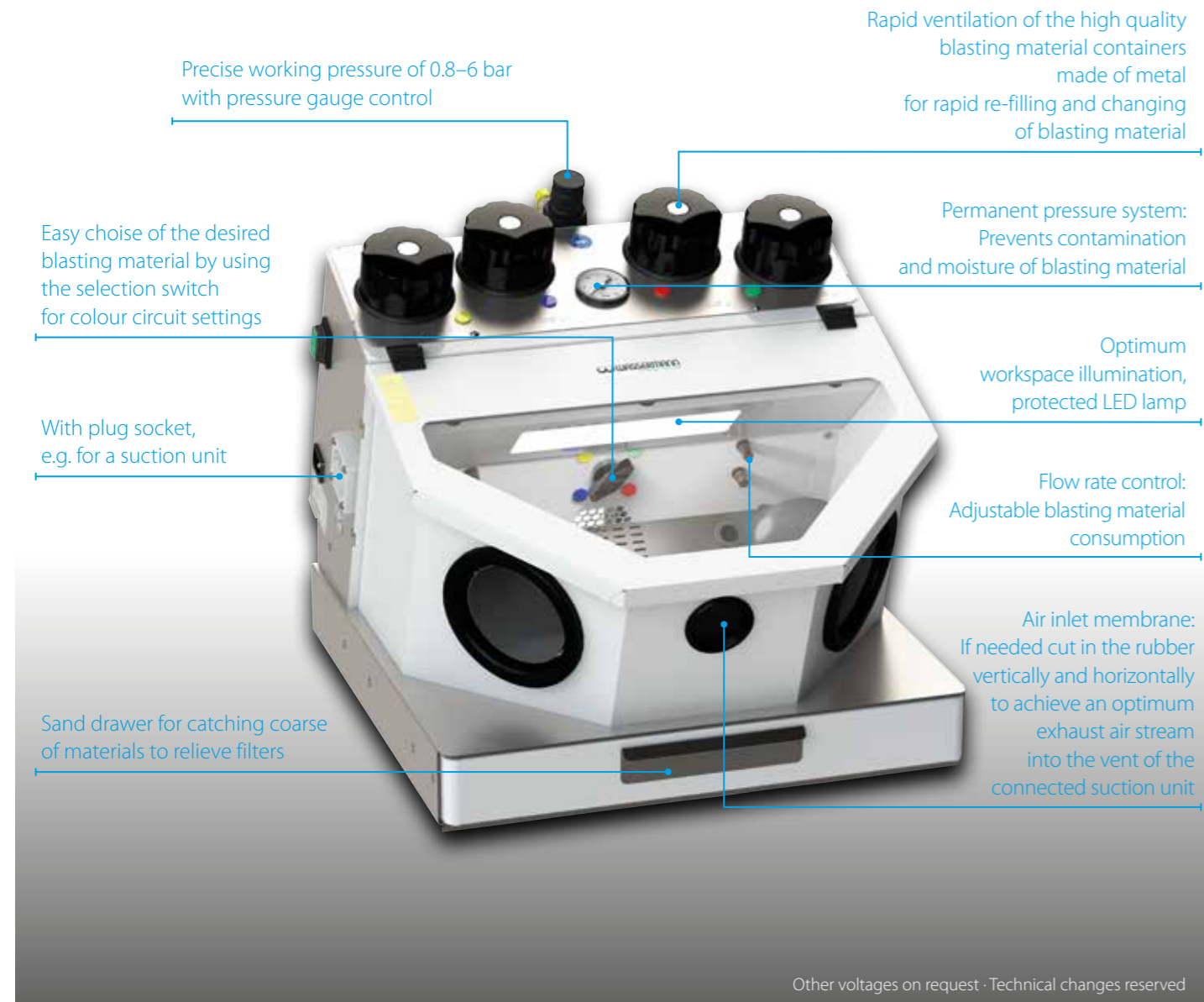

Ergonomically shaped handpieces and a separate air blasting nozzle

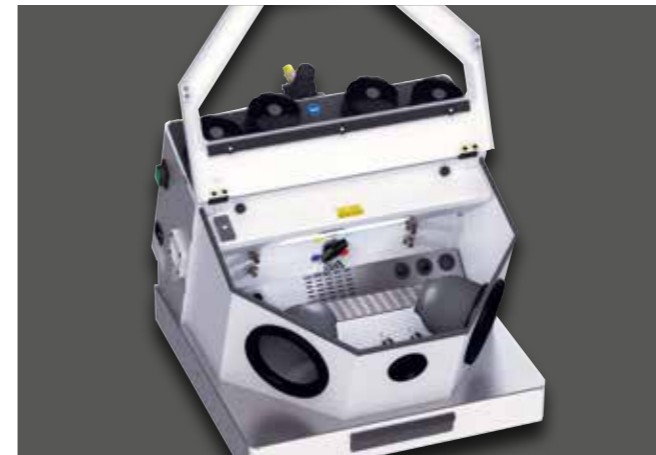

Gobi Comfort-4



Gobi Comfort-3



Gobi Comfort-2

Major Features

- Multifunctional fine blasting units with 2 to 4 chambers
- With handy air blasting nozzle for easy cleaning
- Genuine quick start/stop function, foot-controlled
- Comfortably to handle with ergonomically shaped handpieces
- Cost savings thanks to noticeable low consumption of blasting material
- High hygiene standard because of changeable sleeves
- Special particularly durable hoses
- Convenient colour coding system
- Specially coated safety screen for ideal visibility
- Designed for long durability
- Simple cleaning due to stay-clean surfaces: High quality stainless steel and robust plastic powder coating
- **Included in delivery:**
 - Compressed air hose, 2 m
 - 592012 Supply line 3 core with angle plug (Delivered only on request: 592011 Supply line 3 core US 13 A)
- Gobi Comfort-4** incl. 4 fine blasting nozzles: 0.6 (yellow), 0.8 (blue), 1.2 (red), 0.8 (green)
- Gobi Comfort-3** incl. 3 fine blasting nozzles: 0.8 (blue), 1.2 (red), 0.8 (green)
- Gobi Comfort-2** incl. 2 fine blasting nozzles: 0.8 (blue), 1.2 (red)

Accessories	Item no.
Extractor nozzle Ø 40 mm exterior	143385
Extractor nozzle Ø 50 mm exterior	190286
Compressed air hose per meter	320026
Spare fine blasting nozzle 0.6 mm	190550
Spare fine blasting nozzle 0.8 mm	190551
Spare fine blasting nozzle 1.2 mm	190552

Gobi Comfort-4	Item no. 190884
Gobi Comfort-3	Item no. 190883
Gobi Comfort-2	Item no. 190882

Voltage	100–240 V / 50/60 Hz
Power consumption	0.2 A
Plug socket power consumption	max. 8 A
Output	50 W
W x H x D	445 x 413 x 520 mm
Weight Gobi Comfort-4/ -3/ -2	21.0 kg/ 18.5 kg/ 16.5 kg
Sound level	≤ 70 dB (A)
Tank capacity	420 cm ³
Compressed air connection	3–6 bar
Working pressure	0.8–6 bar
Extractor nozzle	Ø 75 mm exterior

Fine Blasting Unit **Gobi Classic**

The **Gobi Classic** is a precision fine blasting unit with two tanks. It is the perfect unit for sand-blasting, roughening or polishing using all common blasting materials and grain sizes. The unit works precise and has low maintenance. The entire system is continuously under pressure and is therefore always ready for use. Even when switching on the unit again, you can use the quick-start-and quick-stop function to begin blasting immediately. This is possible due to the crushing valve at the conducting hose.

We recommend the use of Wassermann blasting materials and our low-pressure suction units **SG-10**, **SG-1/1** and **SG-1/2 D**.
PVC-hose Ø 75 mm, various lengths available,
see page 78 Accessories for suction technology

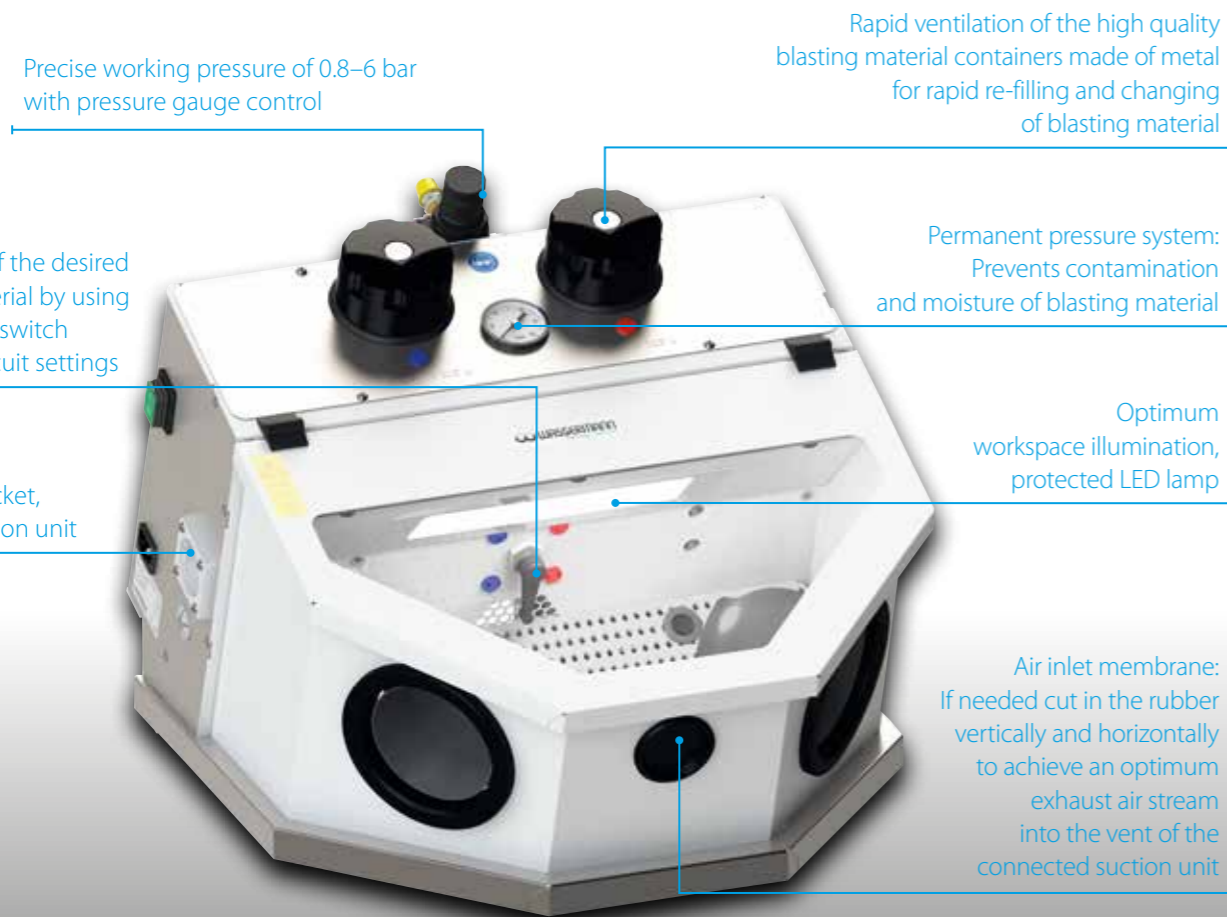

Other voltages on request · Technical changes reserved

Major Features

- Genuine quick start/stop function, foot-controlled
- Comfortably to handle with ergonomically shaped handpieces
- Cost savings thanks to noticeable low consumption of blasting material
- High hygiene standard because of changeable sleeves
- Special particularly durable hoses
- Convenient colour coding system
- Specially coated safety screen for ideal visibility
- Designed for long durability
- Simple cleaning due to stay-clean surfaces: High quality stainless steel and robust plastic powder coating
- **Included in delivery:**
Gobi Classic incl. 2 fine blasting nozzles: 0.8 (blue), 1.2 (red)
 Compressed air hose, 2 m
 592012 Supply line 3 core with angle plug
 (Delivered only on request: 592011 Supply line 3 core US 13 A)

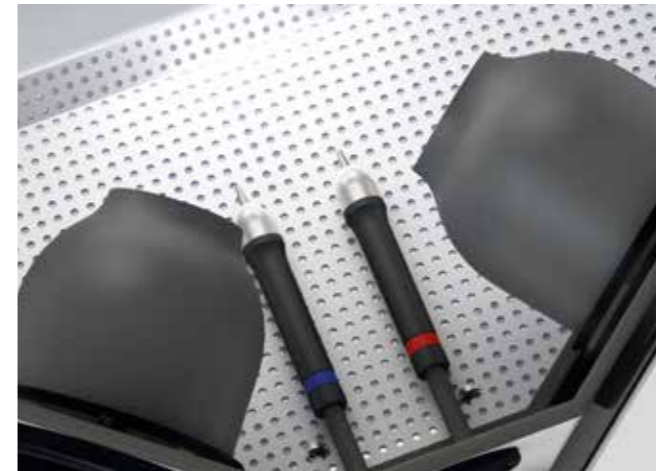
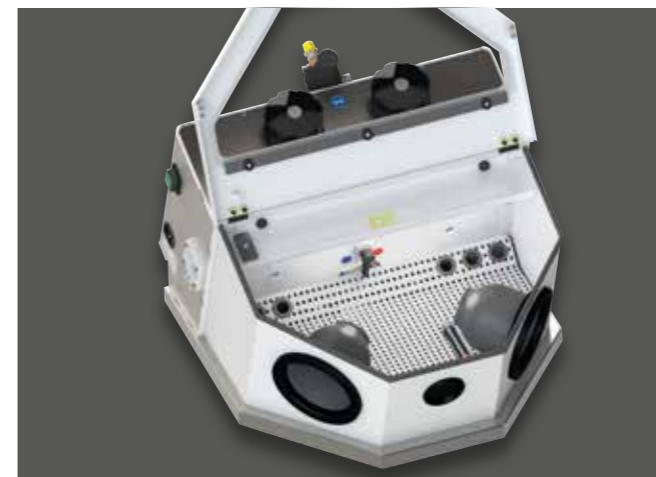

Accessories	Item no.
Extractor nozzle Ø 40 mm exterior	143385
Extractor nozzle Ø 50 mm exterior	190286
Compressed air hose per meter	320026
Spare fine blasting nozzle 0.6 mm	190550
Spare fine blasting nozzle 0.8 mm	190551
Spare fine blasting nozzle 1.2 mm	190552

Gobi Classic	Item no. 190881
Voltage	100–240 V / 50/60 Hz
Power consumption	0.2 A
Plug socket power consumption	max. 8 A
Output	50 W
W x H x D	444 x 372 x 520 mm
Weight	14 kg
Sound level	≤ 70 dB (A)
Tank capacity	420 cm ³
Compressed air connection	3–6 bar
Working pressure	0.8–6 bar
Extractor nozzle	Ø 75 mm exterior

Fine Blasting Unit **Puna II**

Sand-blasting, roughening or polishing in the premium compact class! The **Puna II** fine blasting unit with two tanks enables you to work extremely efficiently and quickly, reliable for many years. It can be used with all common blasting materials and grain sizes for surface finishing. The specialist also impresses thanks to its low consumption of blasting material - and it is not a matter of course in its class.

We recommend the use of Wassermann blasting materials and our low-pressure suction units **SG-10**, **SG-1/1** and **SG-1/2 D**. PVC-hose Ø 75 mm, various lengths available, see page 78 Accessories for suction technology

Precise working pressure of 0.8–6 bar with pressure gauge control

Blasting material tanks made of metal, high quality construction

Easy choice of the desired blasting material by using the selection switch for colour circuit settings

Optimum workspace illumination, protected LED lamp

With plug socket, e.g. for a suction unit

Air inlet membrane: If needed cut in the rubber vertically and horizontally to achieve an optimum exhaust air stream into the vent of the connected suction unit

Other voltages on request · Technical changes reserved



Major Features

- Compact fine blasting unit for daily use at laboratories even in the smallest space
- Easy operation by foot pedal
- Comfortably to handle with ergonomically shaped handpieces
- Noticeable low consumption of blasting material due to the Wassermann air mix system
- High hygiene standard because of changeable sleeves
- Special particularly durable hoses
- Convenient colour coding system
- Specially coated safety screen for ideal visibility
- Designed for long durability
- Simple cleaning due to stay-clean surfaces: High quality stainless steel and robust plastic powder coating
- **Included in delivery:**
Puna II incl. 2 fine blasting nozzles: 0.8 (blue), 1.2 (red)
 Compressed air hose, 2 m
 592012 Supply line 3 core with angle plug
 (Delivered only on request: 592011 Supply line 3 core US 13 A)

Accessories	Item no.
Extractor nozzle Ø 40 mm exterior	143385
Extractor nozzle Ø 50 mm exterior	190286
Compressed air hose per meter	320026
Spare fine blasting nozzle 0.6 mm	190550
Spare fine blasting nozzle 0.8 mm	190551
Spare fine blasting nozzle 1.2 mm	190552

Puna II	Item no. 190885
Voltage	100–240 V / 50/60 Hz
Power consumption	0.2 A
Plug socket power consumption	max. 8 A
Output	50 W
W x H x D	384 x 350 x 472 mm
Weight	11 kg
Sound level	≤ 70 dB (A)
Tank capacity	420 cm ³
Compressed air connection	3–6 bar
Working pressure	0.8–6 bar
Extractor nozzle	Ø 75 mm exterior

Polishing Compact Units WP-Ex 3000 II & WP-Ex 2000 II

Powerful and durable: The WP-Ex 3000 II and WP-Ex 2000 II polishing compact units for daily use at labs guarantee first-class polishing and extraction. Due to their compact size they can be used in the tiniest space. They stand out thanks to their powerful and low-noise extraction and the strong, durable and maintenance-free induction motor. Convenient: The WP-Ex 3000 II is easy to operate due the simple push of a button and the WP-Ex 2000 II even with the ball of the thumb.

Major Features

- Motor with jacket-cooling, dust protected
- Two micro fine dust filterbags with large capacity which are easy to replace guarantee best filter results
- **Included in delivery:**
 Brush spindle right, 92 mm / Brush spindle left, 92 mm
 Micro fine dust filterbag, 1 set = 2 pieces
 Storage bowl (W 257 x H 40 x D 198 mm)
 Drawer (W 621 x H 23 x D 219 mm)
 Polishing trough, 2 pieces
 Supply line



WP-Ex 2000 II (2 settings, 1500 / 3000 min⁻¹), basic equipment



WP-Ex 2000 II with special accessories daylight LED spot and suction protective grids



WP-Ex 3000 II comes as standard with a clear multifunctional display, a motor which is variable in steps and an adjustable daylight LED spot

Emergency off-switch and restart protection guarantee safety at work

Impact-resistant, adjustable safety screen

Easy to clean housing, made almost entirely of stainless steel, integrated drawer

Integrated day-light LEDs

Two easily removable full rubber polishing troughs

Accessories	Item no.
Daylight LED spot (WP-Ex 3000 II comes as standard with daylight LED spot)	146390
Suction protective grid, 1 piece	146396
Brush spindle right, 92 mm	152022
Brush spindle left, 92 mm	152025
Brush spindle right, 125 mm	152043
Brush spindle left, 125 mm	152044
Stone holder right	152056
Stone holder left	152057
Drill chuck right, 1-6 mm clamping	152049
Storage bowl (W 257 x H 40 x D 198 mm)	830409
Spare micro fine dust filterbag, 1 set = 2 pieces	611005
WP-Ex 3000 II	Item no. 146979
WP-Ex 2000 II	Item no. 146978
Voltage	220-240 V / 50/60 Hz
Power consumption	2.8 A
Output	650 W
Fan capacity	445 m ³ /h (free-blowing)
W x H x D	680 x 486 x 527 mm (Height with LED spot: + 140 mm)
Weight with motor	52.0 kg
Sound level	≤ 65 dB (A)
Speed	1500 / 3000 min ⁻¹
Speed WP-Ex 3000 II	additionally adjustable in steps 750-6000 min ⁻¹

Other voltages on request · Technical changes reserved

Polishing Compact Unit WP-Ex 10 II

The WP-Ex 10 II is Wassermann's most compact polishing unit for first class polishing and suctioning in the smallest space - a high quality construction, made almost entirely of stainless steel. In addition to its powerful, longlife and maintenance-free squirrel-cage motor it also convinces with a powerful and low noise suction.



Emergency off-switch and restart protection guarantee safety at work

Integrated daylight LEDs

Impact-resistant, adjustable safety screen

Work area made of stainless steel

Other voltages on request · Technical changes reserved

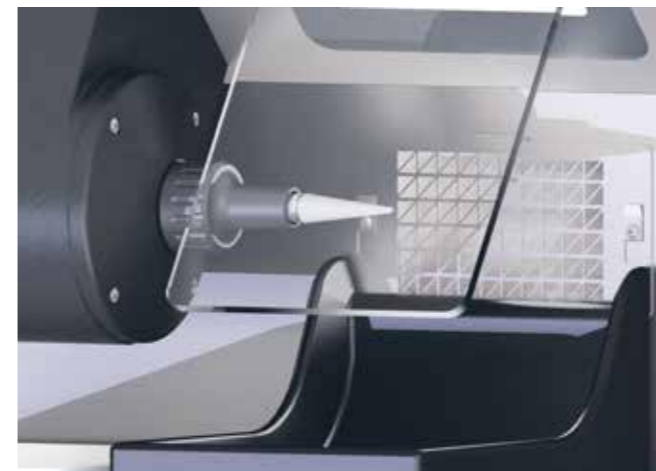

WP-Ex 10 II with special accessory suction protective grid



WP-Ex 10 II with special accessory daylight LED spot



Major Features

- Compact and powerful polishing unit for daily use at laboratories even in the smallest space
- Motor with jacket-cooling, dust protected
- 2 settings, 1500 resp. 3000 min⁻¹
- Micro fine dust filterbag with large capacity which is easy to replace
- Low-noise extraction
- Very convenient: The easy to clean soft-rubber polishing trough can be removed very quickly
- Daylight LED spot available as special accessory
- **Included in delivery:**
 Brush spindle, 92 mm
 Micro fine dust filterbag
 Storage bowl (W 257 x H 40 x D 198 mm)
 Polishing trough
 Supply line

Accessories	Item no.
Daylight LED spot	146390
Suction protective grid, 1 piece	146396
Brush spindle right, 92 mm	152022
Brush spindle right, 125 mm	152043
Stone holder right	152056
Drill chuck right, 1-6 mm clamping	152049
Storage bowl (W 257 x H 40 x D 198 mm)	830409
Spare micro fine dust filterbag, 1 set = 2 pieces	611005

WP-Ex 10 II	Item no. 146971
Voltage	220-240 V / 50/60 Hz
Power consumption	2.2 A
Output	500 W
Fan capacity	445 m ³ /h (free-blowing)
W x H x D	455 x 485 x 505 mm
Weight with motor	37.0 kg
Sound level	≤ 65 dB (A)
Speed	1500 / 3000 min ⁻¹

Polishing Motor WSM-2

The WSM-2 combines years of experience and technical progress in a polishing motor designed for long life and daily use: For grinding, polishing, roughening, cleaning or brushing – fast, clean and safe.

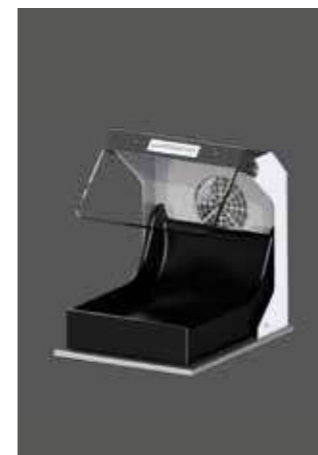
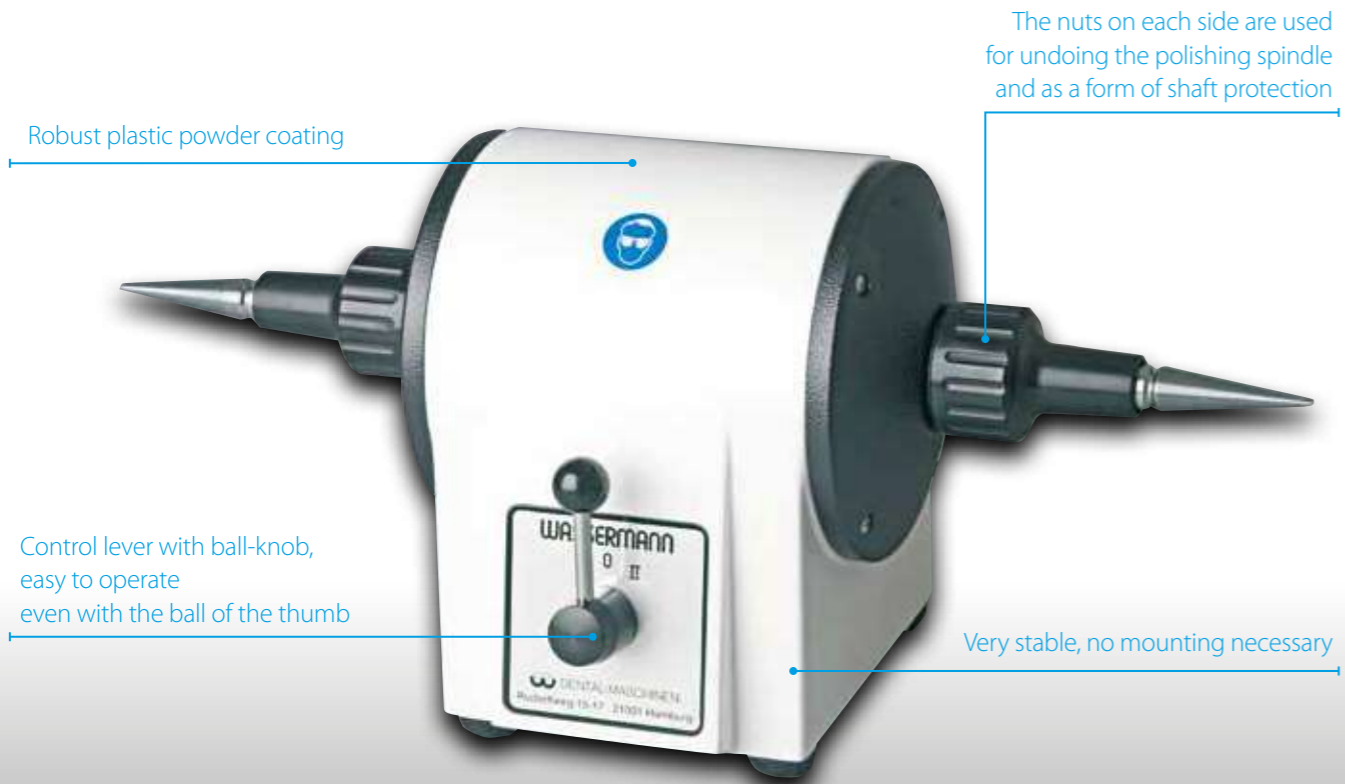

Polishing trough with extractor nozzle



Polishing trough without extractor nozzle



Extraction traverse II for 2 polishing troughs, with switch to guide the air and one extractor nozzle for an external suction unit



WSM-2 with accessories and our low-pressure suction unit SG-1/1

Major Features

- Compact polishing motor with numerous usage options: For metals and plastics, the WSM-2 impresses thanks to its outstanding power
- Extremely low-noise due to permanently lubricated ball bearing
- Powerful 500 W motor
- 2 settings, 1500 resp. 3000 min⁻¹
- Almost maintenance-free for life
- **Included in delivery:**
Brush spindle right, 92 mm
Brush spindle left, 92 mm

Accessories	Item no.
Brush spindle right, 92 mm	152022
Brush spindle left, 92 mm	152025
Brush spindle right, 125 mm	152043
Brush spindle left, 125 mm	152044
Stone holder right	152056
Stone holder left	152057
Drill chuck right, 1-6 mm clamping	152049
Extraction traverse II (W 554 x H 243 x D 163 mm) with output nozzle (Ø 75 mm) for 2 polishing troughs, with switch to guide the air	143550
Polishing trough* with extractor nozzle (Ø 75 mm)	143115
Polishing trough* with extractor nozzle (Ø 40 mm)	143131
Polishing trough* without extractor nozzle	143123

* (W 207 x H 275 x D 292 mm) (H depends on the adjustable safety screen)

WSM-2	Item no. 155999
Voltage	220-240V / 50/60 Hz
Power consumption	2.3 A
Output	500 W
W x H x D	460 x 210 x 195 mm
Weight	13.5 kg
Sound level	≤ 70 dB (A)
Speed	1500 / 3000 min ⁻¹
Height of spindle	130 mm

Automatic Stand

The **automatic stand** by Wassermann offers a robust and ergonomic working surface of high quality that is adjustable in height to suit individual requirements. It makes the workplace much healthier and more active by allowing to work while standing and sitting alternately. Both, health and efficiency will profit from this investment. Ergonomics at the workplace promotes concentrated, relaxed and productive work. The more varied the workplace design, the better it is for the body and performance of the operator.

Plate made of steel with robust plastic powder coating, W x D: 675 x 560 mm, also suitable for external devices

Adjustable from 740–1090 mm, allows to change between standing and sitting at work

With a maximum lifting capacity of 120 kg

Easy to operate using the foot switch

Major Features

- Automatic stand for ergonomically optimised working
- The user can adjust it to any body size in seconds
- Equipped as standard with overload protection of motor

Automatic stand	Item no. 146170
Voltage	220–240 V / 50/60 Hz
Power consumption	3.1 A
Output	660 W
W x min./max. H x D	675 x 740/1090 x 560 mm
Weight	39.7 kg
Stroke	350 mm
Max. load	1200 N (axial) / 120 kg
Lifting speed	approx. 20 mm / sec.



Automatic stand with the polishing compact unit WP-Ex 3000 II

Other voltages on request · Technical changes reserved



First-class quality, skilled staff
and of course
„Made in Germany“

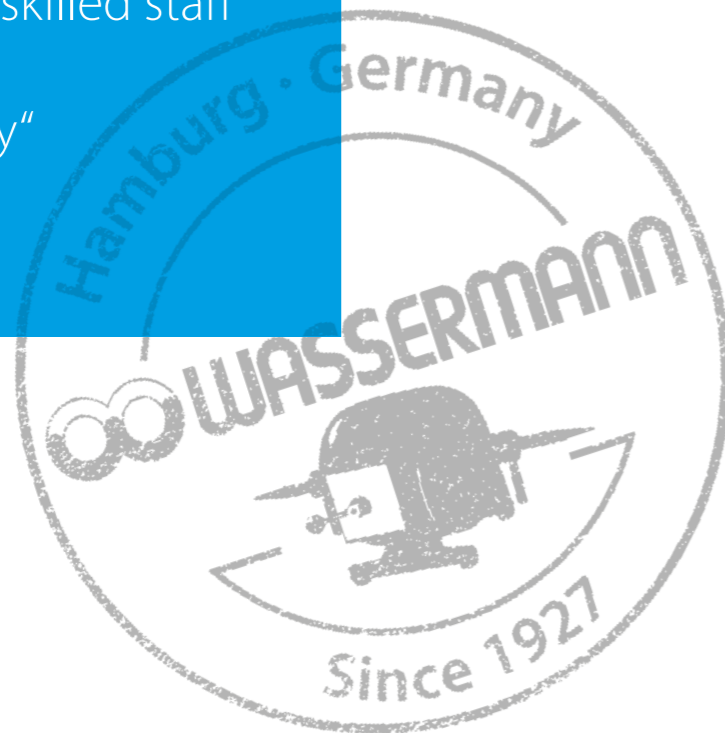

Suction Unit SG-10

The **SG-10** is a multi-function allround unit for many purposes from polishing motors to blasting units. As all Wassermann suction units which works with the low-pressure principle, it sucks up the maximum amount of air at a very low air speed. The advantage: Relaxed and quiet working conditions. A further advantage is the high suction volume, where the hands do not become cold even in continuous operation. The fan motor is a squirrel-cage motor almost free from wear and maintenance-free. Not included, please order separately:

Not included, please order separately:
 PVC-hose Ø 75 mm, various lengths available, see page 78
 Accessories for suction technology



Safety and health in the workplace due to the innovative filter concept, wide range of filters available: From the activated carbon filter to the large volume plaster pre-filter. For further accessories (e.g. PVC-hoses) please see page 78/79.



SG-10 base with module activated carbon filter



SG-10 base with module filter add-on



Modular filter system for different applications

Major Features

- Notably flexible and powerful universal suction unit
- Suitable for continuous operation, high-quality finish
- Filter saturation display
- Easy-to-replace filter system
- Recommended version for our Wassermann fine blasting units
- **Included in delivery:**
 Supply line with switchable shock proof plug
 Speed regulator, fitted on the housing
 Micro fine dust filterbag (yellow) small, dust class M*

Accessories	Item no.
Spare micro fine dust filterbag (yellow) small, dust class M, 1 set = 4 pieces	611010*
Spare filterbag for plaster (white) small, class 1 / class 2, 1 set = 4 pieces	611018*
Spare micro fine dust filterbag (yellow) large, dust class M	610074**
Spare filterbag for plaster (white) large, class 1 / class 2	610073**
Spare activated carbon filter, cpl., AKM 6-ply	140436**
Spare filter cassette, cpl., dust class F	140435**
External speed regulator for fan control, can be retrofitted	140408

To retrofit the SG-10 basic version with an activated carbon filter the following item numbers are necessary

Module filter add-on (without filter)	140410**
Micro fine dust filterbag (yellow) large, dust class M	610074**
Module activated carbon filter: Activated carbon filter (AKM 6-ply), filter cassette (dust class F), filter housing (no fig.), filter frame	140424**

*SG-10 basic version, **SG-10 activated carbon version

SG-10 basic version	Item no. 140988
SG-10 activated carbon version	Item no. 140987
Voltage	220–240 V / 50/60 Hz
Power consumption	0.75 A
Output	110 W
W (without plug) x H x D SG-10 basic version	348 x 423 x 270 mm
W (without plug) x H x D SG-10 activated carbon version	348 x 672 x 270 mm
Weight depends on version	8.2 kg
Sound level	≤ 70 dB (A)
Suction capacity	600 m ³ /h (free-blowing)
Extractor nozzle	Ø 75 mm exterior

Suction Unit SG-1/1

The 1-place-suction SG-1/1 works with Wassermann's reliable low pressure principle; i.e. with suction at very low air speed. The advantage: Relaxed to work with because of its low noise. A further advantage is the high suction volume, where the hands will not become cold even in continuous use. The fan motor is a maintenance-free squirrel-cage motor, suitable for continuous operation and almost free from wear.

Not included, please order separately:
 PVC-hose Ø 75 mm, various lengths available, see page 78
 Accessories for suction technology

Safety and health in the workplace:
 The SG-1/1 is equipped with a high-quality, easily to replace filterbag which is optionally available for micro fine dust or for plaster

Long-life brushless motor

Maximum flexibility because of compact construction design

With plug socket, e.g. for laboratory technology machines or polishing motors



Other voltages on request · Technical changes reserved

Major Features

- 1-place-suction that works with the low pressure principle, multifunctional use – from polishing trough to fine blasting units
- Low noise operation, suitable for continuous operation
- Wide range of accessories available, recommended special accessory SG-1/1: Automatic starting device AS-100 for the automatic start of suction units
- **Included in delivery:**
 Supply line with switchable shock proof plug
 Micro fine dust filterbag (yellow), dust class M



Micro fine dust filterbag, included in delivery



PVC-hoses, available as accessory

Accessories	Item no.
Automatic starting device AS-100	143100
Spare micro fine dust filterbag (yellow), dust class M, 1 set = 4 pieces	611010
Spare filterbag for plaster (white), class 1 / class 2, 1 set = 4 pieces	611018

For further accessories (e.g. PVC-hoses) please see page 78/79.

SG-1/1	Item no. 140995
Voltage	220–240 V / 50/60 Hz
Power consumption	0.75 A
Plug socket power consumption	max. 8 A
Output	170 W
W x H x D	260 x 400 x 330 mm
Weight	9.9 kg
Sound level	59 dB(A)
Suction capacity	500 m ³ /h (free-blowing)
Extractor nozzle	Ø 75 mm exterior



Automatic starting device AS-100, available as accessory

Flexible, compact and really powerful: The **SG-1/2 D** is a multi-function allround unit for many purposes. It works with Wassermann's reliable low pressure principle; i.e. with suction at very low air speed. The advantage: relaxed and nearly noiseless working conditions. A further advantage is the high suction volume, where the hands will not become cold even in continuous operation. The fan motor is a maintenance-free squirrel-cage motor almost free from wear.

Not included, please order separately:
 PVC-hose Ø 75 mm, various lengths available, see page 78
 Accessories for suction technology

- Universal suction unit that works with the low pressure principle
- Multifunctional use – from polishing trough to fine blasting units
- Completely vibration-free and low-noise running
- Automatic switch-off – also of connected appliances – at filter saturation point
- **Included in delivery:**
 Supply line with switchable shock proof plug
 Conductance sheet
 Micro fine dust filterbag (yellow), dust class M



Accessories	Item no.
Spare filterbag for plaster (white) small, class 1 / class 2, 1 set = 3 pieces	611015
Spare filterbag for plaster (white) small, class 1 / class 2, 1 set = 3 pieces	611017

For further accessories (e.g. PVC-hoses) please see page 78/79.

SG-1/2 D	Item no. 140997
Voltage	220–240 V / 50/60 Hz
Power consumption	105 W
Plug socket power consumption	max. 2 A
Output	0.5 A
W x H x D	410 x 460 x 185 mm
Weight	12.7 kg
Sound level	61 dB(A)
Suction capacity	360 m³/h (free-blowing)

Wassermann offers you a comprehensive and perfectly matched product portfolio. Our low pressure suction units in combination with the suction box or the fine blasting units guarantee excellent health protection and the highest degree of profitability. We also supply the appropriate blasting material.



Other voltages on request · Technical changes reserved

Suction Units LSG-02 DE & LSG-02 D

The fully developed suction drawer **LSG-02** is absolutely reliable and is designed precisely for the typical operations in laboratories. The unit starts running automatically when the stand-by mode is switched on and as soon as the drawer is pulled out. If a motorhandpiece is connected to the suction unit it will start running only when the suction drawer is pulled out. At the same time, the motorhandpiece will be turned off when the drawer is closed – hence it is impossible to work without any suction.

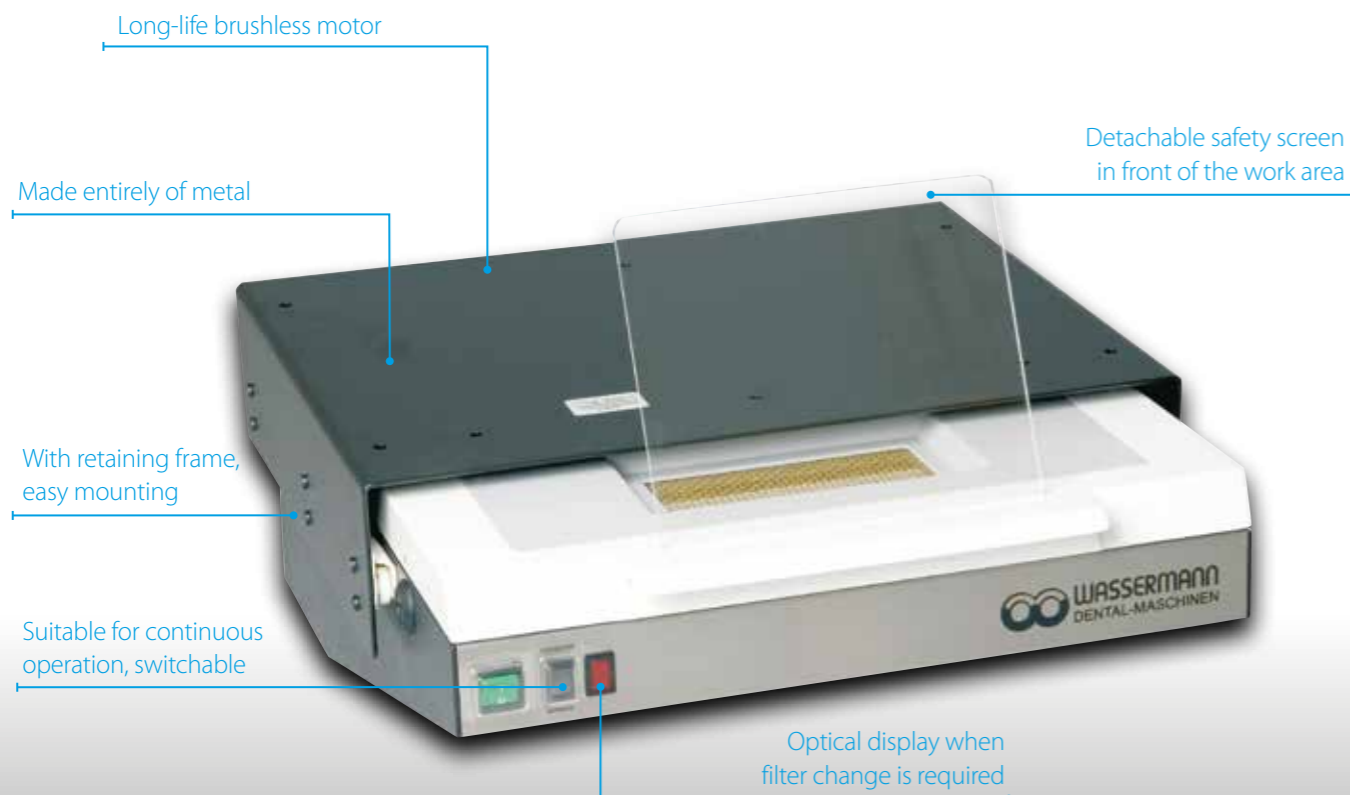

Other voltages on request · Technical changes reserved

Major Features

- Comfortable and durable single workbench suction with high degree of effectiveness
- Switches off automatically at filter saturation point – also all peripheral appliances
- Installation without difficulty, easy to operate, fast filter change
- Practical accessory variations with possibility of later assembly: Gold and debris drawer optionally available as additional drawer, as well as a long-life monomer activated carbon filter
- **LSG-02 DE:** In addition with a practical automatic switch-on device for the automatic start of the suction by the motor handpiece and with an integrated run-on device for even more high safety and health in the workplace
- **Included in delivery:**
Safety screen, acrylic glass 195 x 176 x 3 mm
Micro fine dust filterbag (yellow), dust class M
Supply line

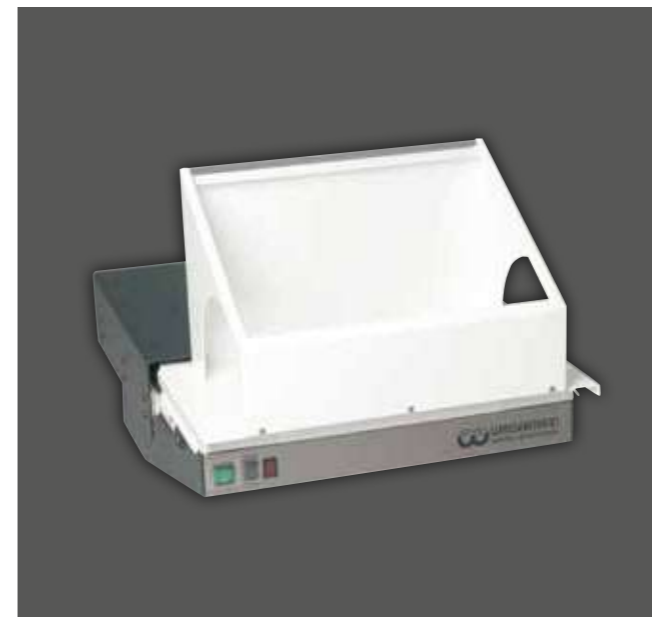

LSG-02 with universal extractor hood



LSG-02 with additional drawer

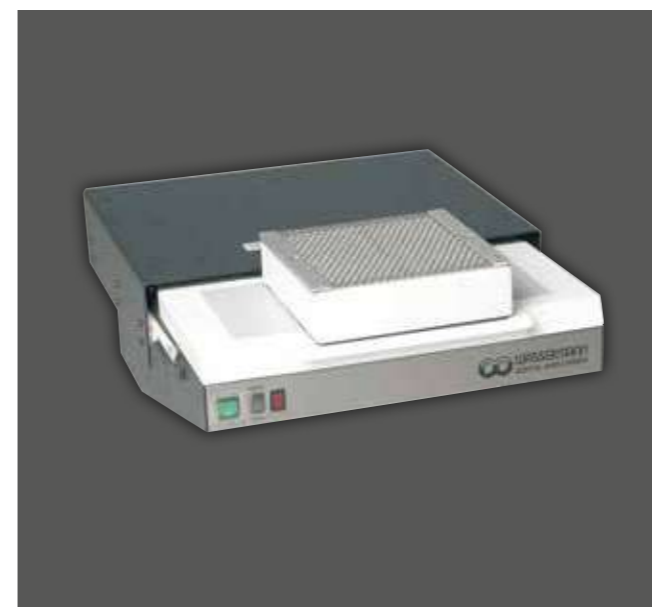

LSG-02 with activated carbon filter

Accessories	Item no.
Additional drawer (can also be retrofitted)	145005
Mounting frame for KaVo tables	145006
Universal extractor hood with base plate	145200
Module activated carbon filter, cpl.	145240
Spare activated carbon filter	610056
Spare micro fine dust filterbag (yellow), dust class M, 1 set = 3 pieces	611015
Spare filterbag for plaster (white), class 1 / class 2, 1 set = 3 pieces	611017

LSG-02 DE LSG-02 D	Item no. 145997 Item no. 145998
Voltage	220–240 V / 50/60 Hz
Power consumption	0.5 A
Power consumption peripheral appliance	max. 2 A
Output	105 W
W x H x D/D max.	445 x 190 x 505 / 720 mm
Weight LSG-02 DE	17.5 kg
Weight LSG-02 D	17.2 kg
Sound level	61 dB(A)
Suction capacity	360 m ³ /h (free-blowing)

Suction Unit **Timobil**

Mobile Suction Table with Motor Handpiece

With the **Timobil** you have a mobile suction unit with robust and ergonomic motor handpiece at your disposal which leaves absolutely nothing to be desired, neither at the dentist's office nor at the dental laboratory: Because of the automatic activator switch the Timobil can be conveniently controlled by the ergonomic and vibration-free motor handpiece.



Other voltages on request · Technical changes reserved

Major Features

- Works with the low-pressure principle: No heat eduction, no cooling of hands, high suction volume, virtually noiseless operation
- High protection because of run-on device of suction unit
- High quality filterbag, easily to be changed
- The extractor hood with or without illumination (available as accessories) can be retrofitted
- **Included in delivery:**
 - Motor handpiece
 - Rest for handpiece
 - Safety screen, acrylic glass
 - Micro fine dust filterbag (yellow), dust class M

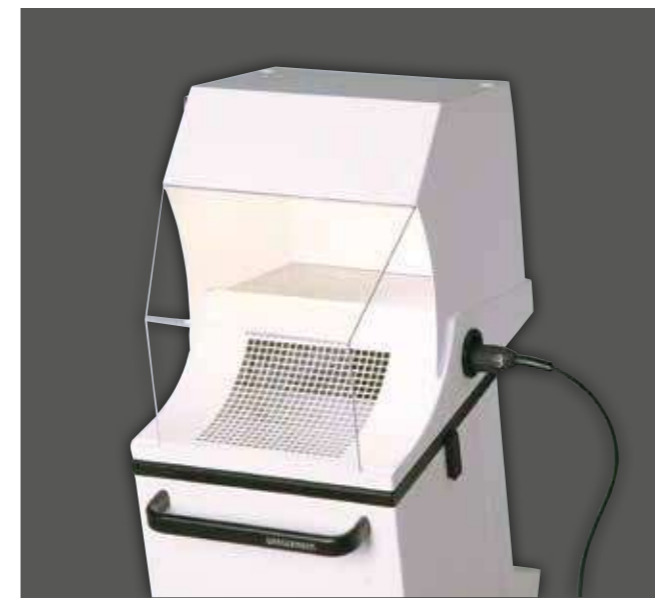

Timobil with accessory extractor hood with illumination



Timobil with accessory extractor hood



Extremely powerful motor handpiece with a constant speed and very low noise

Accessories	Item no.
Extractor hood with illumination	149140
Extractor hood	149130
Storage tray	149010
Spare micro fine dust filterbag (yellow), dust class M, 1 set = 4 pieces	611010
Spare filterbag for plaster (white), class 1 / class 2, 1 set = 4 pieces	611018

Timobil	Item no.149999
Voltage	220–240 V / 50/60 Hz
Power consumption	1.5 A
Plug socket power consumption	max. 8 A
Output	350 W
W x H x D	530 x 900 x 480 mm
Weight	28.1 kg
Suction capacity	500 m ³ /h (free-blowing)
Control unit output	160 W
Handpiece motor output	95 W
Handpiece motor speed	1000 – 40 000 min ⁻¹
Duty	S6 (4 min. / 10 min.)

Suction Box Suction Box Compact III

The **Suction Box Compact III** offers a nearly dust-free operation, and thus meets modern requirements for workplace health and safety. Without the interference of dust, splinters or fumes, it allows the user to work efficiently and relaxed directly on the object. On request the openings for the hands can be additionally sealed with safety covers made of metal. A particular advantage are the two-sided, separate cuts for the handpiece and the sleeves with a lot of moving area and a high standard of hygiene.

Not included, please order separately:
PVC-hose Ø 75 mm, various lengths available, see page 78
Accessories for suction technology

Easy to open, with special-coated safety screen

Sturdy and easy to clean, plastic powder coated, almost maintenance-free and free of wear

Plenty of mobility due to large openings and spacious internal volume

Durable support made of hard beech wood

Excellent view, first class daylight LED illumination

Optional mounting possibility for the extractor nozzle in the front

Air inlet membrane: Only when the safety covers are used, cut in the rubber vertically and horizontally to achieve an optimum exhaust air stream into the vent of the connected suction unit

Other voltages on request · Technical changes reserved



Suction Box Compact III, basic equipment with large openings, spacious internal volume and optional mounting possibilities for the extractor nozzle in the front or in the rear



Suction Box Compact III, basic equipment, the extractor nozzle is optionally mounted in the front



Suction Box Compact III with accessories: Set of arm rests for working without tiring



Suction Box Compact III with accessories: Set of safety covers with sleeves and separate cuts for the handpiece

Major Features

- Ergonomic shape for optimal physical carriage
- High safety standard: Protection against splinters, dust and fumes
- Tilt and skid resistant
- Quality magnifier, arm rests and safety covers optionally available
- Perfectly matched to the combination with our low-pressure suction units **SG-10**, **SG-1/1** and **SG-1/2 D**
- **Included in delivery:** **Suction Box Compact III** with daylight LED illumination and 1 extractor nozzle (optional mounting in the front or in the rear)

Accessories	Item no.
Magnifying glass	143251
Set of arm rests	143303
Set of safety covers	143305
Extractor nozzle Ø 40 mm exterior	143385
Extractor nozzle Ø 50 mm exterior	190286
Various adapters Ø 75 mm (inner) available on request	---
Suction-Box Compact III	Item no. 143390
Voltage	100–240 V / 50/60 Hz
Power consumption	0.1 A
Output	15 W
W x H x D	370 x 310 x 345 mm
Weight	5.5 kg
Extractor nozzle (Optional mounting in the front or in the rear)	Ø 75 mm exterior

Accessories Suction Technology

Hoses	Fig.	Item no.
PVC-hose Ø 75 mm, 1.20 m length with 2 hose clamps	-	140057
PVC-hose Ø 75 mm, 1.80 m length without hose clamps	-	320011
PVC-hose Ø 75 mm, 2.40 m length without hose clamps	-	320010
PVC-hose Ø 75 mm, 3.60 m length without hose clamps	-	320012
Hose clamp Ø 75 mm	-	322003
PVC-hose Ø 51 mm, inner, per meter	-	327023

Filter SG-10 basic version, SG-1/1, Timobil	Fig.	Item no.
Spare micro fine dust filterbag (yellow) small, dust class M, 1 set = 4 pieces	-	611010
Spare filterbag for plaster (white) small, class 1 / class 2, 1 set = 4 pieces	-	611018

To retrofit the SG-10 standard version with an activated carbon filter the following item numbers are necessary:

- 140410 Module filter add-on (without filter)
- 610074 Micro fine dust filterbag (yellow) tall, dust class M*
- 140424 Module activated carbon filter: Activated carbon filter (AKM 6-ply), filter cassette (dust class F), filter housing, filter frame

Filter SG-10 activated carbon version	Fig.	Item no.
Spare micro fine dust filterbag (yellow) large, dust class M	-	610074*
Spare filterbag for plaster (white) large, class 1 / class 2	-	610073*
Spare activated carbon filter, cpl., AKM 6-ply	-	140436**
Spare filter cassette, cpl., dust class F	-	140435**

*to be used only in combination with item no. 140410 module filter add-on

**to be used only in combination with item no. 140424 module activated carbon filter

Filter SG-1/2 D, LSG-02 DE/D	Fig.	Item no.
Spare micro fine dust filterbag (yellow), dust class M, 1 set = 4 pieces	-	611020
Spare filterbag for plaster (white), class 1 / class 2, 1 set = 3 pieces	-	611017

Accessories LSG-02 DE/D	Fig.	Item no.
Module activated carbon filter, cpl.	1	145240
Spare activated carbon filter	-	610056
Universal extractor hood	2	145200
Additional drawer	3	145005



Fig. 1



Fig. 2

Fig. 3

Accessories Timobil	Fig.	Item no.
Extractor hood	4	149130
Extractor hood with illumination	5	149140



Fig. 4

Fig. 5



Suction Box Compact III	Fig.	Item no.
Suction Box Compact III with daylight LED illumination and 1 extractor nozzle Ø 75 mm exterior (optional mounting in the front or in the rear)	6	143390

Accessories Suction Box Compact III	Fig.	Item no.
Magnifying glass	-	143251
Set of arm rests	7	143303
Set of safety covers	8	143305
Extractor nozzle Ø 40 mm exterior	-	143385
Extractor nozzle Ø 50 mm exterior	-	190286
Various adapters Ø 75 mm (inner) available on request	-	-



Fig. 6



Fig. 7

Fig. 8

Spezial channels and appropriate suction parts	Fig.	Item no.
Special channel with hose coupling	-	143093
Extractor hand vise	9	143038
Extractor nozzle	10	143041

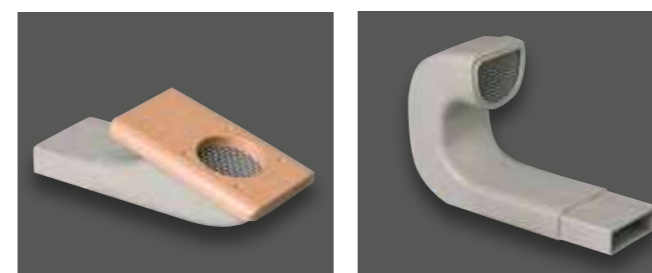

Fig. 9

Fig. 10

Telescopic channels and appropriate suction parts	Fig.	Item no.
Telescopic channel 570 mm	11	143070
Telescopic channel 455 mm for Freuding tables	12	143090
Telescopic channel 480 mm amongst others for Mann tables	-	143074
Suction part with wooden rest	13	143220
Suction part with wooden rest, plastic screen	14	143221
Suction part with wooden rest, glass screen	15	143231
Suction part, straight	16	143080
Suction part, transverse	17	143066
Cap (for 143066)	18	143108
Safety glass screen (for 143080/ 143066), adjustable, incl. holder	19	143110

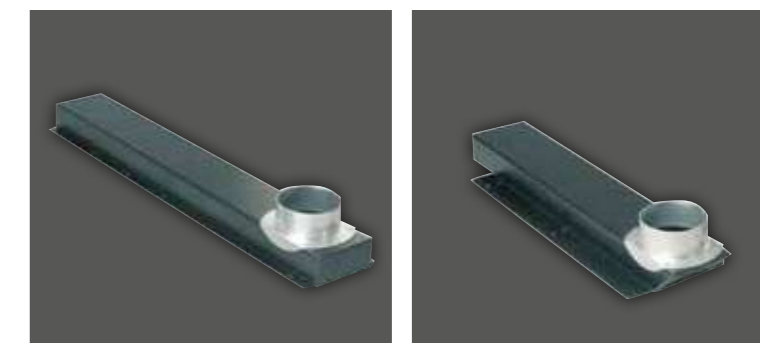

Fig. 11

Fig. 12



Fig. 13

Fig. 14

Fig. 15



Fig. 16

Fig. 17

Fig. 18

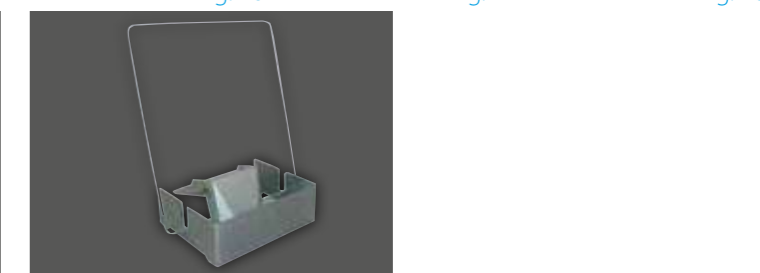
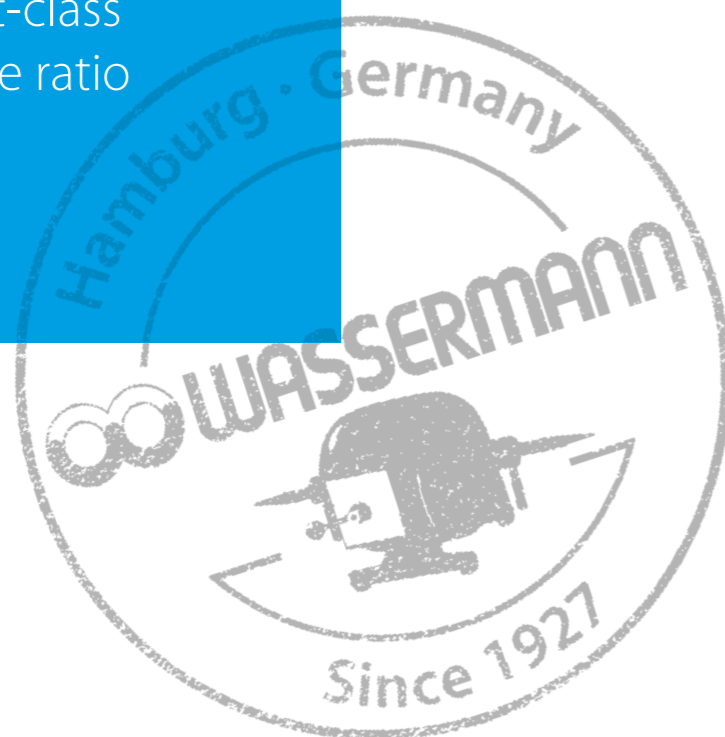

Fig. 19



Products with first-class price-performance ratio



Duplicating Silicone **WaSil soft & WaSil speed**

- Addition-vulcanizing duplicating silicone, 1:1
- DIN EN ISO 14356
- Type 2 - irreversible
- Duplicating material
- WaSil duplicating silicones are suitable for mixing with dosing units

WaSil soft

- Recommended for duplicating with conventional flasks
- High reproduction of detail graphic accuracy
- Easy model removal caused by reduced hardness

Technical information

Mixing ratio	1 : 1
Vacuum mixing	40 sec.
Working time 23 °C	> 5 min
Curing time 23 °C	30 – 45 min
Tear strenght (DIN 53504)	approx. 1.8 N/mm ²
Elongation at tear (DIN 53504)	approx. 220 %
Tear-growth resistance (ASTMD 624 B)	approx. 3.0 N/mm ²
Hardness Shore A	16–18
Colour	yellow

Trading unit	Fig.	Item no.
WaSil soft 2 x 1 kg component A / B	1	656060
WaSil soft 2 x 6 kg component A / B	2	656061
WaSil soft 2 x 25 kg component A / B	–	656062



Fig. 1



Fig. 2



Fig. 3



Fig. 4

WaSil speed

- For the adhesive tape and flasking techniques
- Easy and economical dosing
- Ideal low viscosity

Technical information

Mixing ratio	1 : 1
Vacuum mixing	40 sec.
Working time 23 °C	3–4 min
Curing time 23 °C	10 min
Tear strenght (DIN 53504)	approx. 2.2 N/mm ²
Elongation at tear (DIN 53504)	approx. 310 %
Tear-growth resistance (ASTMD 624 B)	approx. 6.5 N/mm ²
Hardness Shore A	> 24
Colour	turquoise

Trading unit	Fig.	Item no.
WaSil speed 2 x 1 kg component A / B	3	656070
WaSil speed 2 x 6 kg component A / B	4	656071
WaSil speed 2 x 25 kg component A / B	–	656072

We recommend the use of our dosing and mixing unit **Sidomix II**.



Dosing and Mixing Unit Sidomix II (Item no. 172980)
 Material and time saving:
 Loss-free filling of several flasks with one mixing cannula.
 The mixing head with separate outlets makes mixing of components impossible – even when attaching and removing the mixing cannulas.

Mixing canulas	Fig.	Item no.
Mixing canulas 1:1, inner Ø 5.4 mm, pink, 100 pieces, for dosing and mixing unit Sidomix II/ Sidomix and similar units	5	622002
Adapter-sets	Fig.	Item no.
Adapter-set, for 2 x 1 kg-cask	6	172634
Adapter-set, for 2 x 6 kg-cask	7+9	172636
Material casks	Fig.	Item no.
Set material cask with quick fitting coupling, 2 x 2 liter	8	172640
Stands	Fig.	Item no.
Stand small, for 2 x 6 kg-cask	–	172631
Stand tall, for 2 x 25 kg-cask	–	172632
Hoses	Fig.	Item no.
Connecting hoses complete, 2 pieces	–	172633



Fig. 5



Fig. 6



Fig. 7



Fig. 8



Fig. 9

Blasting Materials Aluminium Oxide & Glass Beads

Optimised for use with our fine blastig units.

Aluminium oxide, blasting material white

- Made in Germany
- Purity grade 99.8 %
- Very efficient blasting caused by enormous hardness and sharp-edged grains
- Conform to industrial safety authority requirements
- Silicosis-free
- 3 sorting grades: 50 µm - 110 µm - 250 µm



Trading unit	µm	Item no.
10 kg canister	50	656010
20 kg canister	50	656015
10 kg canister	110	656013
20 kg canister	110	656016
10 kg canister	250	656014
20 kg canister	250	656018

Glass beads

- Made in Germany
- For gentle cleaning and compacting of sensitive surfaces of precious and non-precious alloys, for example crowns, bridges and model casting
- Silicosis-free
- Available as corn class 50 µm and 125 µm



Trading unit	µm	Item no.
8 kg canister	50	656020
15 kg canister	50	656021
8 kg canister	125	656019
15 kg canister	125	656022

Changes reserved

Service & Spare Parts

Wassermann products incorporate the highest standards of quality and the latest technology. In order to enjoy maximum performance and years of trouble-free operation, we offers you a comprehensive and perfectly matched product portfolio and **spare parts in stock** for a period of many years.

The **serial number** allows us to find quickly without any doubt the correct answers for the needs of your machine. The **identification plate** is located on the back or right side of your unit.

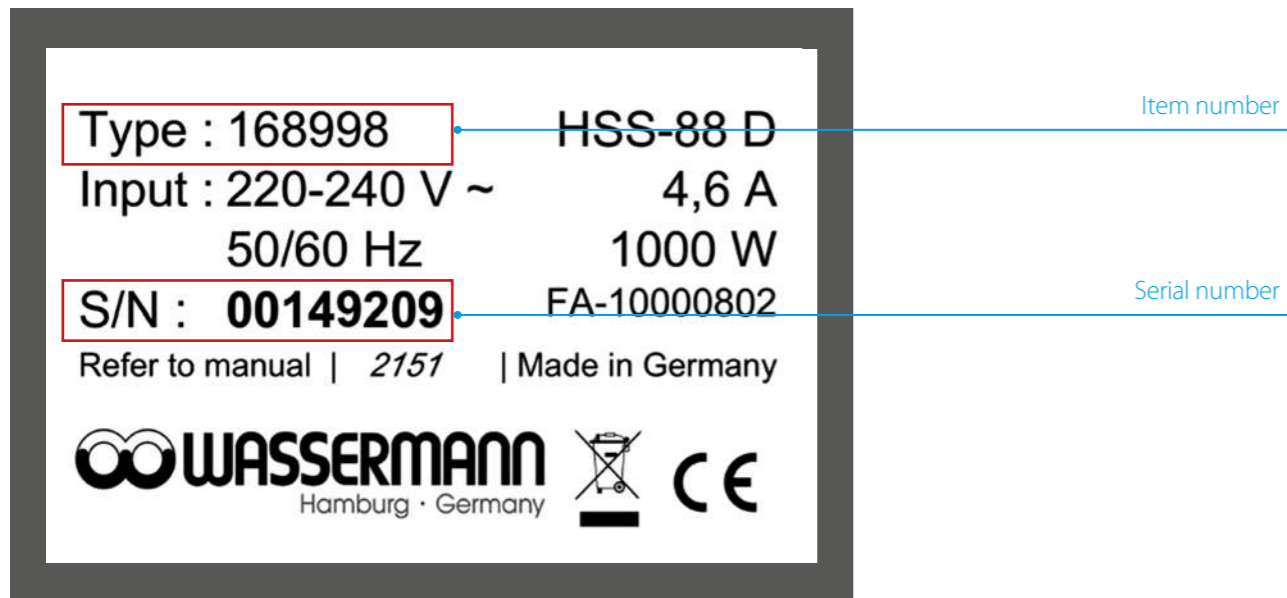

Example of an identification plate at your device



Parts/Accessories Store

www.wassermann.hamburg/en/wassermann-shop/shop.html

NOTE: ONLY WITHIN GERMANY

Shipping and billing address has to be located within Germany.

Your Contact at Wassermann

You have questions concerning our products or services? Contact us! We guarantee quickest possible handling and we will provide you personally with competent, dedicated help. Thank you for contacting us!

Sales Europe & Worldwide

Phone: +49 (0)40 730 926 -20 / -24

Fax: +49 (0)40 730 37 24

E-mail: export@wassermann-dental.com

Sales Germany

Phone: +49 (0)40 730 926 -25 / -26

Fax: +49 (0)40 730 37 24

E-mail: sales@wassermann-dental.com

Service & Support

Phone: +49 (0)40 730 926 -50

Fax: +49 (0)40 730 37 24

E-mail: service@wassermann-dental.com

Head Office

Phone: +49 (0)40 730 926 - 24

Fax: +49 (0)40 730 37 24

E-mail: export@wassermann-dental.com



Follow us on Facebook

[/WassermannDentalmaschinen](https://www.facebook.com/WassermannDentalmaschinen)



Wassermann Dental-Maschinen GmbH

Rudorffweg 15-17 · 21031 Hamburg · Germany

Phone: +49 (0)40 730 926 -24

Fax: +49 (0)40 730 37 24

export@wassermann-dental.com

www.wassermann-dental.com

www.wassermann.hamburg

www.facebook.com/WassermannDentalmaschinen

Comm. Reg. No.: Hamburg HRB 15214

VAT Reg. No.: DE 118 02 5998

WEEE-Reg. No.: DE 32827129

EORI No.: DE3629678

Managing Director: Dipl.-Ing. (FH) Sven Wassermann

Edition 2022-03

It is subject to change without prior notice and cannot be considered binding to the seller for any specific period.

Specifications are subject to alteration without prior notice.

As standard the powder coating is in the following colours: Natural white close to RAL 9016 and black close to RAL 9005. Colours are also subject to change without notice. Alternative colours are available at additional surcharge.

www.wassermann.hamburg



Wassermann Dental-Maschinen GmbH
Rudorffweg 15–17 · 21031 Hamburg · Germany
Phone: +49 (0)40 730 926-20/ -24 · Fax: +49 (0)40 730 37 24
export@wassermann-dental.com · www.wassermann.hamburg
www.facebook.com/WassermannDentalmaschinen

www.stomshop.pro