

 E4



SAME-DAY DENTISTRY:

# EASY



**4**  
Axes

**1**  
Block

**7**  
Tools

Wet  
Dry

Grind  
Mill

CAM  
Software  
incl.

<https://stomshop.pro/>

The logo for vhf, consisting of the lowercase letters 'vhf' in a bold, black, sans-serif font. The letters are positioned above a thick red horizontal bar that extends to the right of the text.

# OUR INNOVATIVE MACHINE FOR EASY ENTRY INTO SAME- DAY DENTISTRY.

Digitize your practice with the E4. You and your patients can benefit from restorations in just one session of treatment.



**E4**

# CHAIRSIDE PRODUCTION IS SO EASY.

The new E4 makes it so easy for you to get started with chairside production of dental restorations, and gives you maximum freedom. Combine the E4 with your preferred intra-oral scanner, any CAD software and materials that are appropriate for your individual patients. The E4 is the heart of your workflow and produces the perfect restoration for you.

**The integrated CAM software enables you to get started right away!**



**Your  
patients  
will love it:  
the new  
E4.**



Dr. Nicolas Rohde  
Chief Strategy Officer  
vhf camfacture AG

<https://stomshop.pro/>

# MAKE YOUR PATIENTS SMILE.

Impress your patients with a quick and comfortable treatment and produce perfect restorations – easily and in just one session. Your patients won't thank you enough.



## RELIABILITY MEETS PRECISION.

Developed and manufactured entirely in Germany, the E4 guarantees impressive manufacturing results and optimum reliability. Despite its compact design, the machine comprises only high-quality industrial components in the housing.

With a machine weight of only 28 kg and no use of compressed air, the E4 offers maximum flexibility in terms of installation. You can set the E4 anywhere. True to the motto: unpack, connect, start milling!

<https://stomshop.pro/>





## THE ALL-ROUNDER FOR BLOCKS.

The E4 has many talents. Wet grind glass ceramics or composites with ceramic content and dry mill materials such as zirconia and PMMA.

### A small change with a big effect.

Benefit from easy switching: Insert the tank for wet processing or the optional container for machining dust and start processing high-quality restorations. A special filter mat in the liquid tank ensures that the tank is free of chippings.

### Wet grinding

The PUREWATER Technology ensures that the closed liquid circuit in the machine requires no grinding additives. For you, this means easy disposal and even lower running costs.



### Dry milling

The optional dry container enables you to mill materials such as zirconia, PMMA and various composites with your E4 with no cooling water or compressed air.









**FLEXIBILITY  
MADE EASY.**

# MATERIAL, MANUFACTURER, INDICATION.

Enjoy great freedom of choice.

<b>Compo- sites</b>	<b>PMMA &amp; Wax</b>	 Crown   Bridge	 Inlay   Onlay	 Veneer
<b>Glass ceramics</b>	<b>Zirconia</b>	 Abutment	 Screw-retained crown	

*Be sure to review local and/or national regulations and/or regulations by other authorized organizations or entities (e.g. professional associations, health authorities).*





# NO COMPRESSED AIR WITH THE INNOVATIVE TECHNOLOGY.

One great innovation of the E4 is that it does not use compressed air: The E4 requires neither an external compressed air connection nor an integrated compressor, which is only possible with our patent-pending AIRTOOL.

The AIRTOOL turbine blades use the speed of the high-frequency spindle to generate a powerful air flow, which keeps the workpiece free from dust and chippings. They are removed by vacuum from a dust collector.



## SERVICE? EASY!

If your machine requires servicing, the central components, e.g. the spindle, are easy to replace and you can even service the machine yourself in just a few steps. In addition, the lightweight and service-optimized design saves transport time and resources.

<https://stomshop.pro/>



# THE ADVANTAGES? THERE ARE SO MANY!



## Innovative

No compressed air required with the patent-pending AIRTOOL

Machine design optimized for minimal weight

Multi-compartment for cooling liquid tank or optional dry milling container

Modular machine design to optimize servicing and maintenance



## Reliable

100% developed and manufactured in Germany

Optimum manufacturing results and high durability with only premium-quality industrial components

24-month guarantee



## Fast & precise

800 W 60,000 rpm spindle

3 µm repetition accuracy

Sturdy aluminum welded construction



## Independent

DENTALCAM software with open interface to CAD software and materials

Virtually any intraoral scanners can be used

Grinds and mills almost all block materials up to 45 mm long from numerous manufacturers

A full range of materials for glass ceramics, composites, zirconia and plastics



## Cost-effective

Sustainable operation with no compressed air

The PUREWATER Technology ensures that no grinding additives are required for the cooling liquid

Environmentally friendly shipping due to low weight of machine

The excellent price-performance ratio ensures a cost-effective entry into in-house production

Extremely simple operation with provided DENTALCAM software featuring DIRECTMILL Technology – no license fees



# TECHNICAL DATA

## GENERAL

Fields of application	Wet/dry machining
Materials	Composites, plastics/wax, glass ceramics, zirconia • Blocks up to 45 × 20 × 20 mm
Indications	Crowns, bridges, inlays, onlays, veneers, zirconia abutments, Screw-retained crowns
Holder systems	Integrated block holder

## BASIC SYSTEM

Construction	Sturdy aluminum welded structure
Housing	White high-gloss lacquer finish · upward opening lift door to the workroom
Number of axes	4
Linear axes X-/Y-/Z-axis	Precision ball screws · motors with resolution < 1 µm · ground precision guides made of high-alloyed steel · repetition accuracy ± 0.003 mm
Rotary axis A-axis	Rotation angle: +190° to –10°
Control unit	5-axis simultaneous control electronics with continuous path progression and dynamic pre-calculation · hardware-based real-time operating system with standardized instruction set · FPGA-integrated processor · updateable hardware · real-time path and ramp calculation via dedicated hardware engines in the FPGA · four-quadrant control of the motors for particularly smooth running · multiple digital I/Os for controlling the peripherals · integrated inverter for synchronous and asynchronous motors, electronic gate detection · Ethernet and USB interface
Lighting	Backlit workspace through RGB LED lighting with status indication

## SPINDLE

General	High-frequency spindle with electromechanical tool change
Speed	Up to 60,000 rpm
Power	Peak power (P <sub>max</sub> ): 800 watts · nominal power (S6): 400 watts · continuous power (S1): 300 watts
Bearing	2-fold hybrid ceramic ball bearing
Collet	For tools with 3 mm shank diameter and max. 40 mm total length

## AUTOMATION

Tool change	Removable tool magazine for 6 tools with additional space for one AIRTOOL · length measurement and tool break-age monitoring via precision measuring key · access via working chamber flap, safety-locked
Access combination compartment	Direct insertion of the coolant tank or (optional) dry container in compartment directly under the working chamber

## PROCESSING MODES

Wet	2 fluid nozzles on the spindle · integrated cooling liquid tank · PUREWATER Technology: no grinding additives required
Dry	Compressed air-free operation through use of AIRTOOLS · hose connection for external suction unit on the back of the housing · 24 V switch output for controlling suction units · optional dry container required

## CONNECTION REQUIREMENTS

Compressed air	–
Power supply	100–240 volts · 50/60 Hz, 500 watts
Extraction System	Extraction filter class M, 2,500 l/min extraction capacity at 220 hPa
Data	10/100/1000 MBit/s BaseT port (auto-sensing) Ethernet via RJ-45 socket

## ENVIRONMENTAL CONDITIONS

Operating temperature	Between 10 °C and 35 °C
Air moisture	Max. 80 % (relative), non-condensing

## APPROVALS

All models	CE
North America model	UL 61010-1, CAN/CSA C22.2 No. 61010-1

## DIMENSIONS & WEIGHTS

Dimensions (W/D/H)	360 × 370 × 490 mm with closed door · 360 × 420 × 490 mm with open door
Footprint (W/D)	270 × 268 mm
Weight	28 kg

## SCOPE OF DELIVERY

CAM Software	DENTALCAM software included
Accessories	Spindle service set · calibration set incl. stirrup measuring screw · tool magazine inserts (1 piece) · Torx wrench set · torque driver 1.5 Nm · AIRTOOL for wax and plastics · drill bit (tool positions) · cleaning brush and microfiber cloth · TecPowder (3) · foam filter · power cable · Ethernet network cable

**E4**

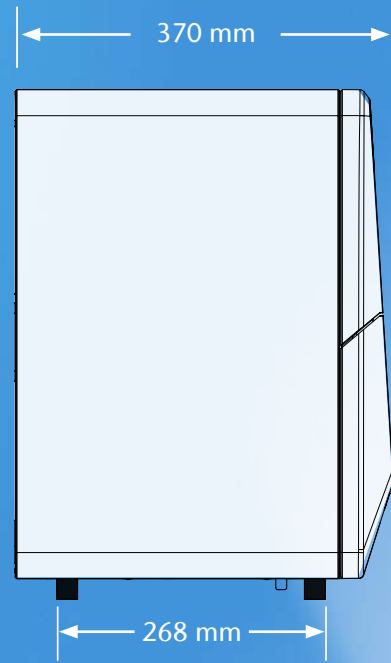
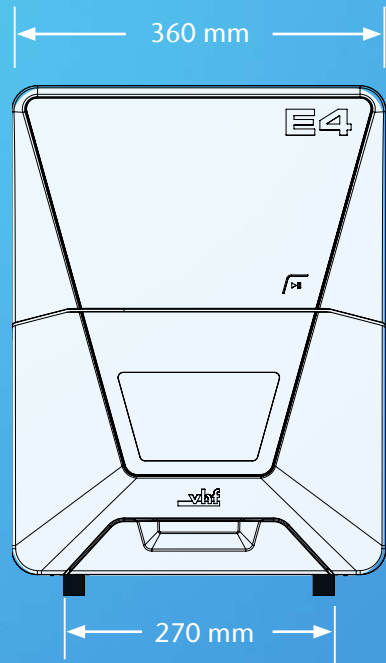
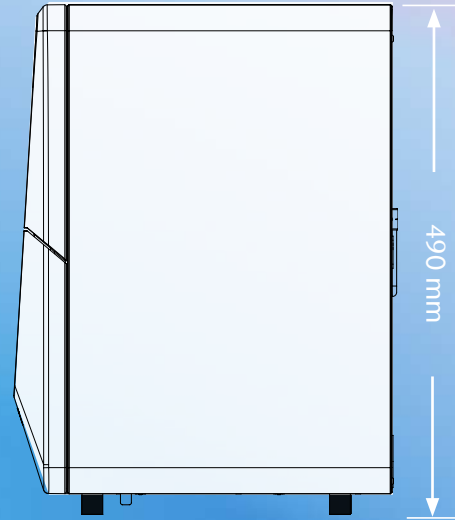
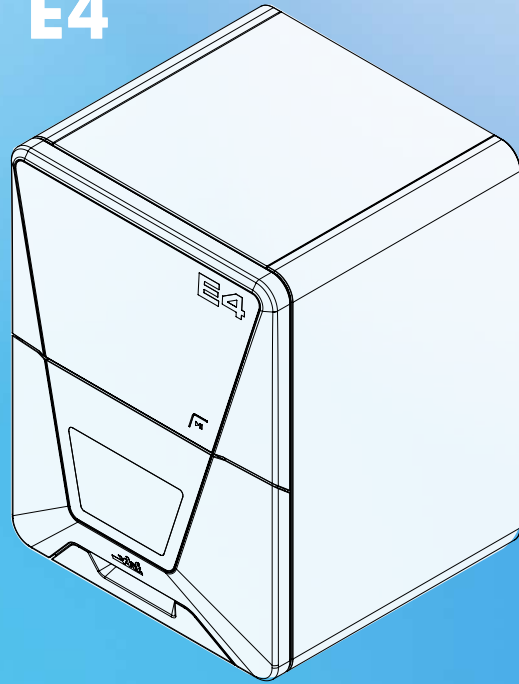

**I'd never have thought that same-day dentistry could be so easy. A seamless workflow from the intraoral scanner to the perfect restoration, which I can use with virtually no reworking.**

**My patients are impressed with the quick treatment in one session.**

Dr. Ingo Baresel  
Dentist, Cadolzburg

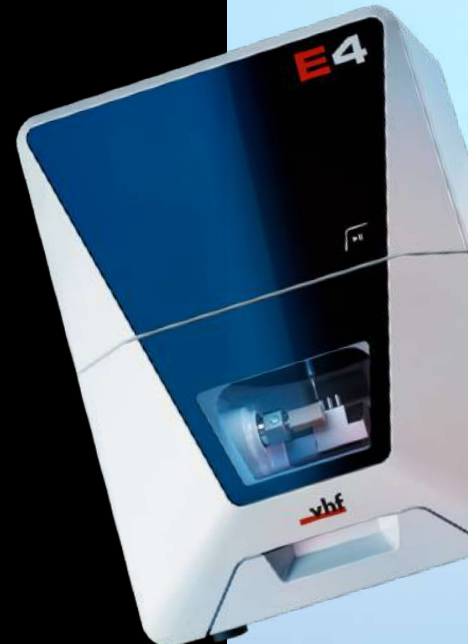

## Creating Perfection.

With more than 30 years of experience, vhf is a leading manufacturer of dental milling machines. As a CAM full-service provider, vhf meticulously develops and produces each individual milling machine and the perfectly matched tools and software all in-house. Everything from a single source. Made in Germany.

## Service. We are passionate about what we do.

Our products are extremely low-maintenance and highly durable, but the servicing of your machine is important to us. We provide customer support with our user-friendly DentalPortal, numerous online tutorials and personal assistance through our international service network.

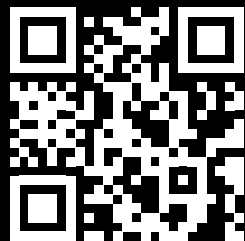

[ease.vhf.com/E4](https://ease.vhf.com/E4)



**WE LOOK FORWARD TO HEARING FROM YOU.**

### Headquarters

vhf camufacture AG  
Lettenstraße 10  
72119 Ammerbuch  
Germany  
+49 7032 97097 000  
info@vhf.de | vhf.com

### North America

vhf Inc.  
80 Davids Drive, Suite 5  
Hauppauge, NY 11788  
USA  
+1 631 524 5252  
info@vhf.com | vhf.com

### Asia

vhf Trading (Shanghai) Co., Ltd.  
Room 2902, Building T1, Tianshan SOHO,  
No. 421 Ziyun Road, Changning District,  
Shanghai China  
asia@vhf.de | vhf.com

<https://stomshop.pro/>