

mectron



→ MECTRON  
ULTRASONIC INSERTS



# → ULTRASONIC INSERTS

→ MULTIPIEZO *white*

## → A LARGE VARIETY OF APPLICATIONS

Scaling, perio, endo, restorative – mectron offers a wide range of applications. mectron's high-quality technique guarantees maximum treatment power and utmost security in each single unit.

This remarkable quality is the result of the successful combination of fine electronic concept and a special tips design.



→ COMBI touch



→ MICROPIEZO S



→ MULTIPIEZO touch



→ MULTIPIEZO PRO



→ COMPACT PIEZO LED



→ COMPACT PIEZO P2K



# → THE INSERTS



A range of more than 45 inserts is available for different uses. The surface has been enhanced with titanium nitride to make it tougher than traditional ultrasound inserts.

mectron inserts are supplied in kits that allow both a proper storage and an effective sterilisation.



→ INSERT KIT

These small and handy kits are made of stainless steel (no aluminium).

The blue silicon rings perfectly hold the inserts.



# CONTENTS

---

---

---

---

→ 8-16 INSERT KITS

- 8/9 kit scaling/kit scaling high efficiency
- 10/11 kit perio universal/kit perio anatomic
- 12/13 kit endo/kit endo revision
- 14/15 kit endo retro/kit cavity margin
- 16 kit restorative

→ 18-23 SCALING INSERTS

- 18/19 Insert S1/Insert S1-S
- 20/21 Insert S2/Insert S3
- 22/23 Insert S4/Insert S5

→ 24-26 SCALING HIGH EFFICIENCY INSERTS

- 24/25 Insert S6/ Insert S7
- 26 Insert S8

→ 28-31 PERIO UNIVERSAL INSERTS

- 28/29 Insert P1/Insert P2
- 30/31 Insert P3/Insert P4

→ 32-39 PERIO ANATOMIC INSERTS

- 32/33 Insert P10/ Insert P11
- 34/35 Insert P12/ Insert P13
- 36/37 Insert P14/Insert P15
- 38/39 Insert P16R/Insert P16L

→ 40-41 IMPLANT CLEANING INSERTS

→ 42-45 ENDO INSERTS

- 42/43 Insert E1/Insert E2
- 44/45 endo files

→ 46-51 ENDO REVISION INSERTS

- 47 Insert ER1
- 48/49 Insert ER2/Insert ER3
- 50/51 Insert ER4/Insert ER5

→ 52-60 ENDO RETRO INSERTS

- 53 Insert R1
- 54/55 Insert R2/Insert R3
- 56/57 Insert R4/Insert R5
- 58/59 Insert RD3/Insert RD4
- 60 Insert RD5

→ 62-65 EXTRACTION INSERTS

- 63 Insert ME1
- 64/65 Insert ME2/Insert ME3

→ 66-67 CROWN PREP TIPS

→ 68-71 CAVITY MARGIN INSERTS

- 68/69 Insert CM1/Insert CM2
- 70/71 Insert CM3/Insert CM4

→ 72-75 RESTORATIVE INSERTS

- 72/73 Insert D1/Insert D2
- 74/75 Insert D3/Insert D4

→ 76-77 APPROPRIATE INSERT SETTINGS

→ 78-79 REFERENCE NUMBERS/TIP CARD

# → KIT SCALING

## → EQUIPPED WITH:

- 1 insert S1
- 1 insert S2
- 1 insert S3
- 1 insert S4
- 1 insert S5

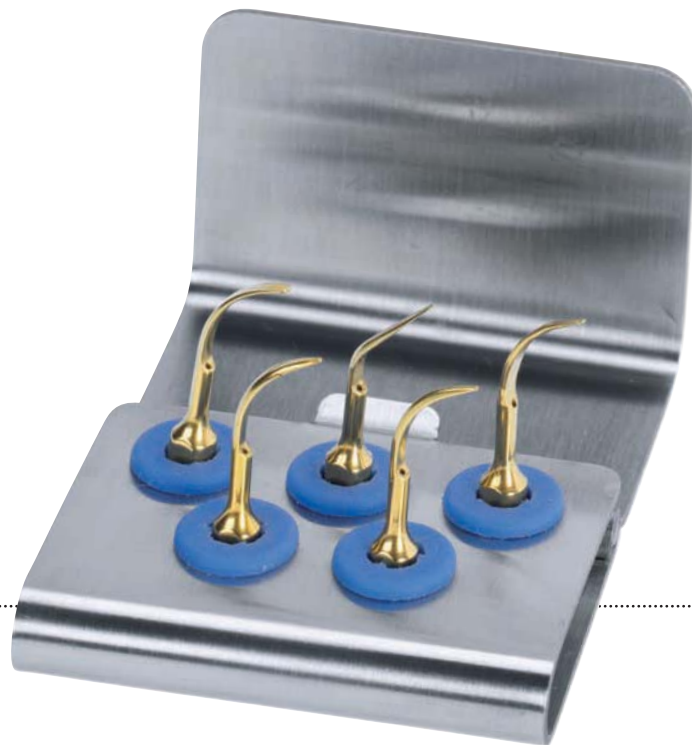

→ S1    → S2    → S3    → S4    → S5

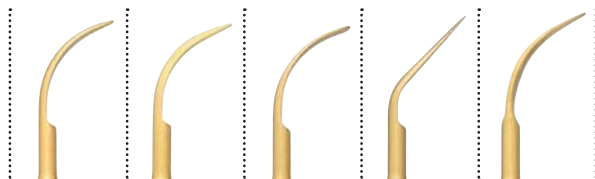



# → KIT SCALING HIGH EFFICIENCY

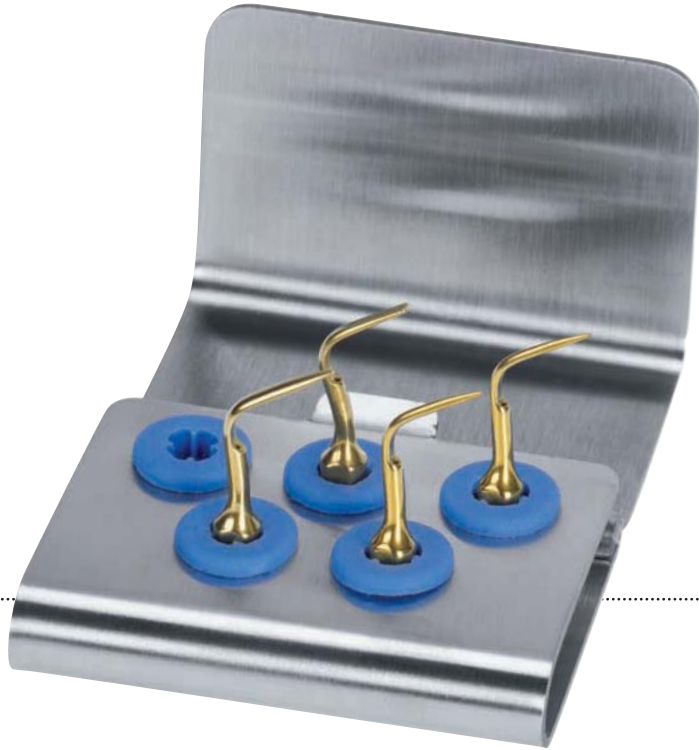

## → EQUIPPED WITH:

- 2 inserts S6
- 1 insert S7
- 1 insert S8

→ S6    → S7    → S8

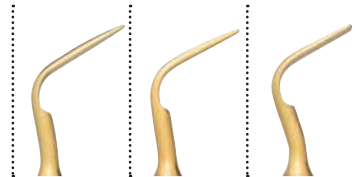

INSERT KITS

# → KIT PERIO UNIVERSAL

## → EQUIPPED WITH:

- 1 insert P1
- 1 insert P2
- 1 insert P3
- 1 insert P4

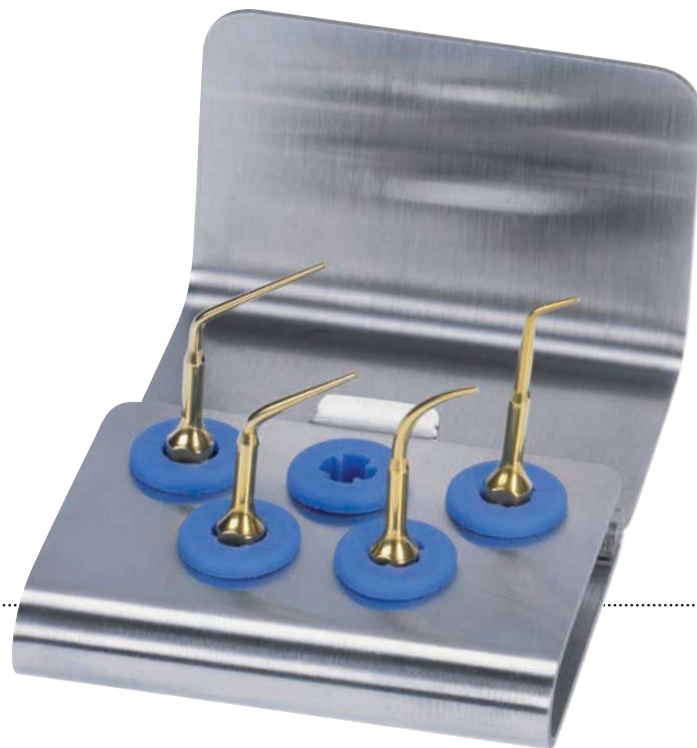

→ P1    → P2    → P3    → P4



# → KIT PERIO ANATOMIC

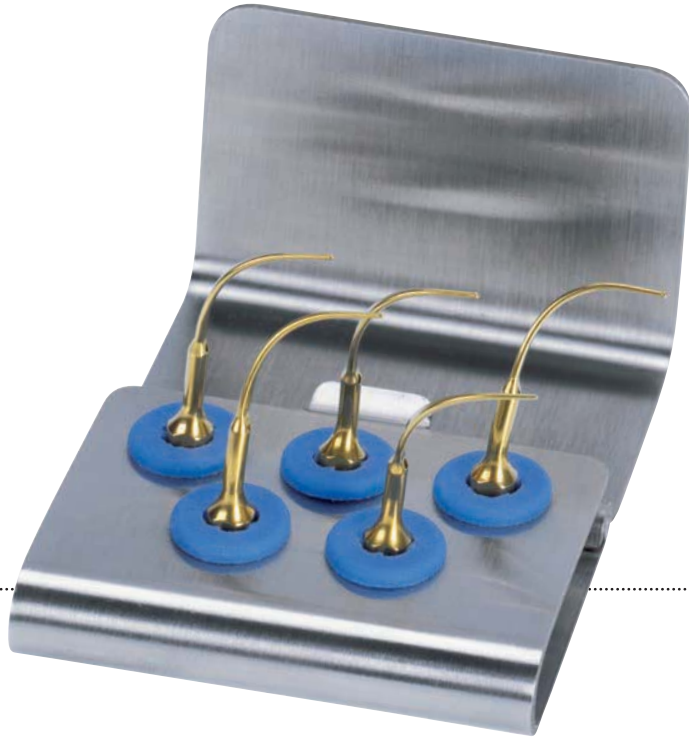

## → EQUIPPED WITH:

- 1 insert P10
- 1 insert P11
- 1 insert P12
- 1 insert P13
- 1 insert P14

→ P10    → P11    → P12    → P13    → P14

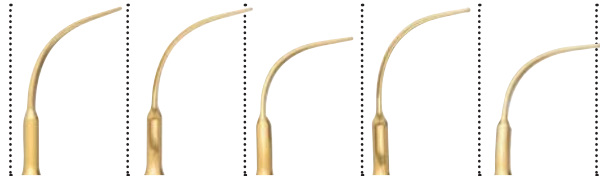

# → KIT ENDO

## → EQUIPPED WITH:

- 1 file holder E1 120°
- 1 file holder E2 90°
- 6 NiTi-files ISO 15, 27 mm
- 6 NiTi-files ISO 20, 27 mm
- 6 NiTi-files ISO 25, 27 mm
- 6 NiTi-files ISO 15, 31 mm
- 6 NiTi-files ISO 20, 31 mm
- 6 NiTi-files ISO 25, 31 mm
- 1 wrench K1
- 1 wrench for endo files



→ E1

→ E2



# → KIT ENDO REVISION



## → EQUIPPED WITH:

- 1 insert ER1
- 1 insert ER2
- 1 insert ER3
- 1 insert ER4
- 1 insert ER5

→ ER1   → ER2   → ER3   → ER4   → ER5

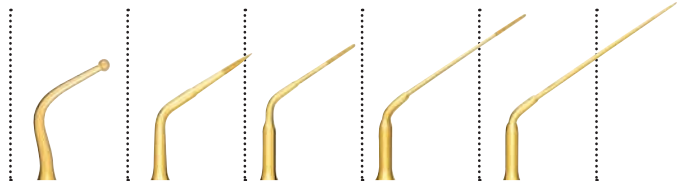

INSERT KITS

# → KIT ENDO RETRO

## → EQUIPPED WITH:

- 1 insert R1
- 1 insert R2
- 1 insert R3
- 1 insert R4
- 1 insert R5



→ R1   → R2   → R3   → R4   → R5

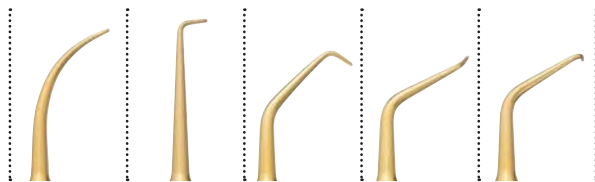

# → KIT CAVITY MARGIN



## → EQUIPPED WITH:

- 1 insert CM1
- 1 insert CM2
- 1 insert CM3
- 1 insert CM4

→ CM1 → CM2 → CM3 → CM4

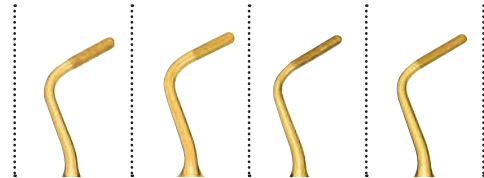

# → KIT RESTORATIVE

## → EQUIPPED WITH:

- 1 insert D1
- 1 insert D2
- 1 insert D3
- 1 insert D4

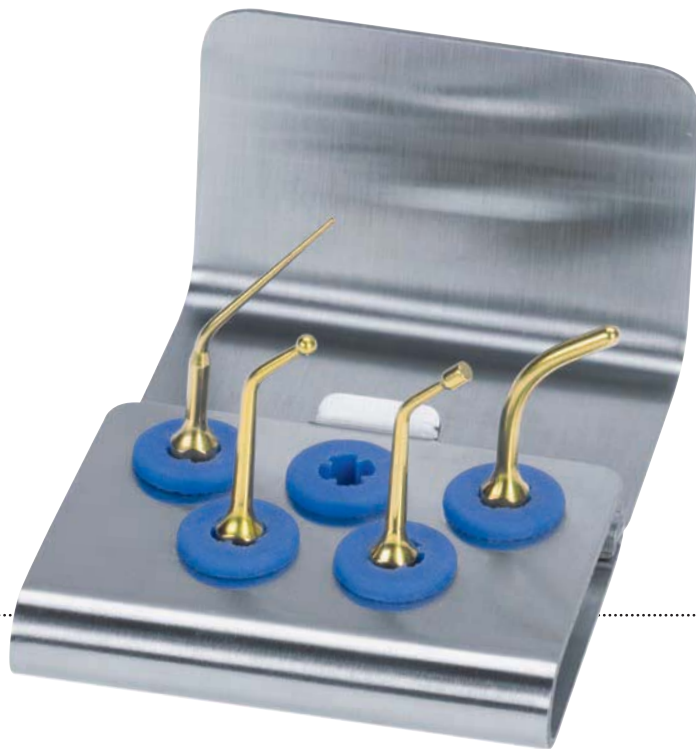

→ D1    → D2    → D3    → D4

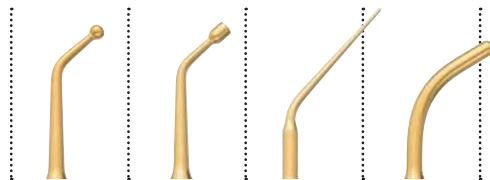





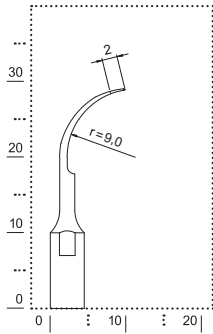

- IDENTIFICATION  
scaling
- MORPHOLOGY  
universal curette with semicircular diameter
- SURFACE  
titanium nitride coat
- TREATMENT  
for considerable tartar removal

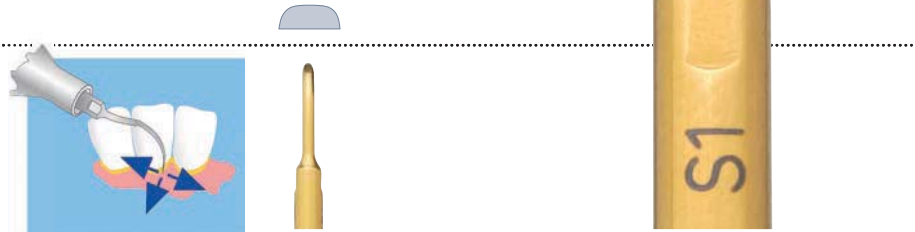



- IDENTIFICATION  
perio/scaling
- MORPHOLOGY  
long universal curette with triangled slightly curved surface
- SURFACE  
titanium nitride coat
- TREATMENT  
for supragingival tartar removal and subgingival concretions and biofilm elimination

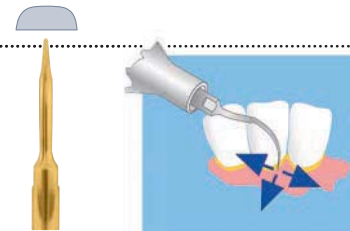
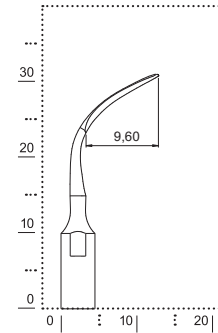

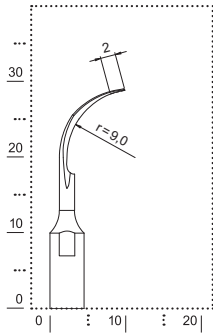

- IDENTIFICATION  
scaling
- MORPHOLOGY  
universal curette with triangled, slightly curved surface
- SURFACE  
titanium nitride coat
- TREATMENT  
efficient in the interdental spaces and posterior surfaces

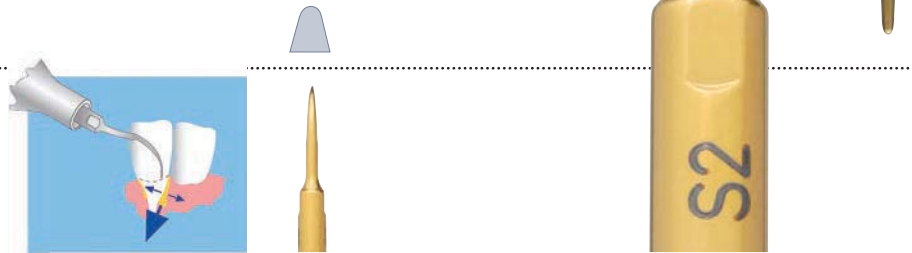



- IDENTIFICATION  
scaling
- MORPHOLOGY  
flat, with rounded edges
- SURFACE  
titanium nitride coat
- TREATMENT  
for considerable supragingival  
tartar removal

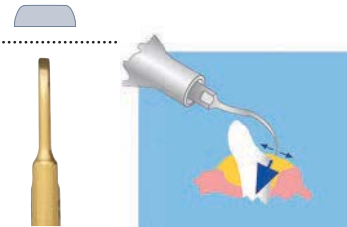
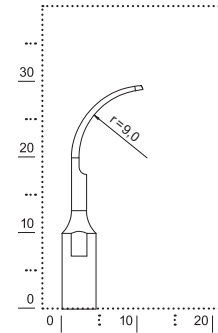

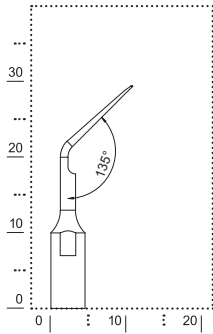

- **IDENTIFICATION**  
scaling
- **MORPHOLOGY**  
universal curette with 45° angled, triangled and slightly curved surface
- **SURFACE**  
titanium nitride coat
- **TREATMENT**  
for tartar removal on mesial and distal interdental surfaces in the posterior area

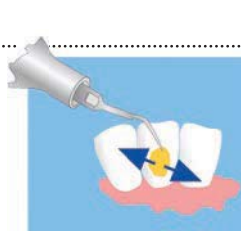



- **IDENTIFICATION**  
scaling
- **MORPHOLOGY**  
similar shape to S1 insert  
but longer and thinner
- **SURFACE**  
titanium nitride coat
- **TREATMENT**  
for gentle supra- and subgingival  
tartar removal and for gingivitis

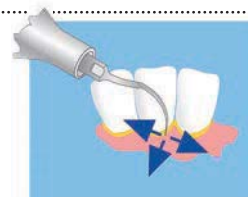
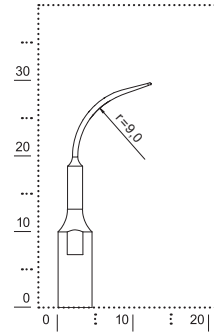

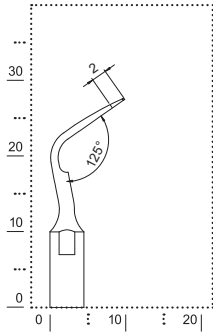

- **IDENTIFICATION**  
scaling
- **MORPHOLOGY**  
contra-angled universal curette with  
semicircular diameter
- **SURFACE**  
titanium nitride coat
- **TREATMENT**  
powerful insert (twice the power of S1 insert)  
for considerable tartar removal

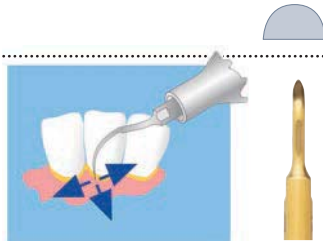





- IDENTIFICATION  
scaling
- MORPHOLOGY  
contra-angled universal curette with  
triangled, slightly curved surface
- SURFACE  
titanium nitride coat
- TREATMENT  
powerful insert (twice the power of  
S2 insert) efficient in the interdental  
spaces and posterior surfaces

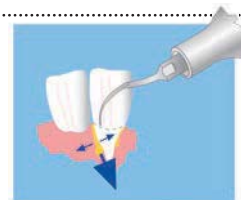
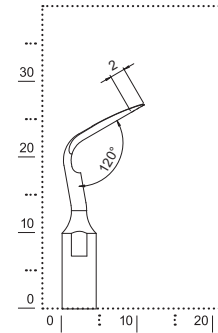

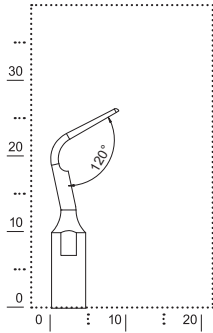

→ IDENTIFICATION

scaling

→ MORPHOLOGY

contra-angled, flat working surface with round edges

→ SURFACE

titanium nitride coat

→ TREATMENT

powerful insert (twice the power of S3 insert) for considerable supragingival tartar removal

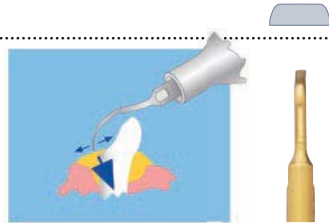



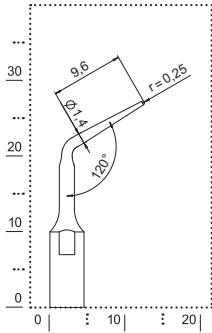

- IDENTIFICATION  
perio
- MORPHOLOGY  
long, straight working tip with a circular surface
- SURFACE  
titanium nitride coat
- TREATMENT  
for concrements and biofilm  
removal from root surfaces





- IDENTIFICATION  
perio
- MORPHOLOGY  
curved working tip with a circular surface
- SURFACE  
titanium nitride coat
- TREATMENT  
for concrements and biofilm  
removal from root surfaces

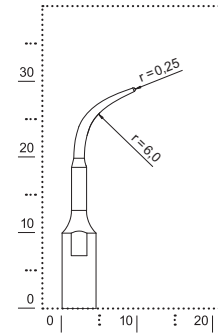

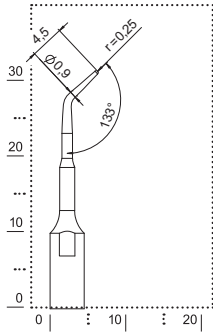

- IDENTIFICATION  
perio
- MORPHOLOGY  
straight long shaft, short working tip  
with a circular surface
- SURFACE  
titanium nitride coat
- TREATMENT  
for concrements and biofilm removal  
in furcations





- IDENTIFICATION  
perio
- MORPHOLOGY  
extra long, straight working tip  
with a circular surface
- SURFACE  
titanium nitride coat
- TREATMENT  
for concrements and biofilm removal  
from root surfaces

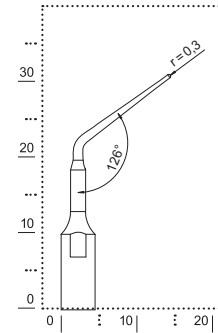

# → P10

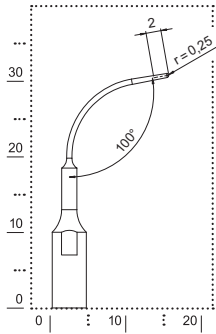

- IDENTIFICATION  
perio
- MORPHOLOGY  
extra long, curved working tip  
with a circular surface
- SURFACE  
titanium nitride coat
- TREATMENT  
for concrements and biofilm removal  
from root surfaces







- IDENTIFICATION  
perio
- MORPHOLOGY  
right (inclination of 15°) curved insert  
with round tip
- SURFACE  
titanium nitride coat
- TREATMENT  
for gentle subgingival concrements removal

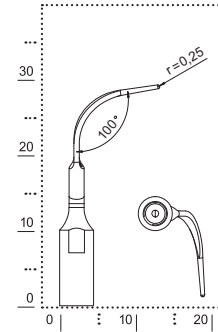

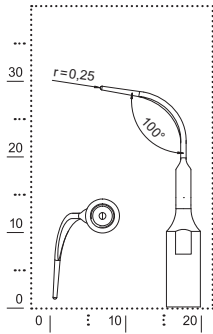

- IDENTIFICATION  
perio
- MORPHOLOGY  
left (inclination of  $15^\circ$ ) curved insert  
with round tip
- SURFACE  
titanium nitride coat
- TREATMENT  
for gentle subgingival concrements removal





→ IDENTIFICATION

perio

→ MORPHOLOGY

right (inclination of 15°) curved insert with spherical (Ø = 0.8 mm) round tip

→ SURFACE

titanium nitride coat

→ TREATMENT

for concrements and biofilm removal in furcations and concavities

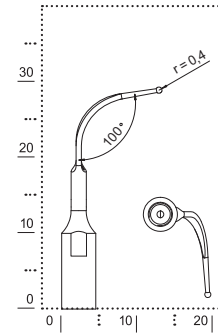

# → P14

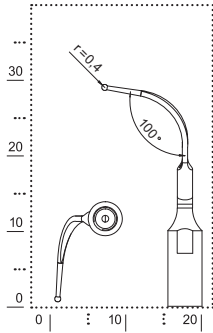

→ IDENTIFICATION

perio

→ MORPHOLOGY

left (inclination of 15°) curved insert with spherical ( $\varnothing = 0.8$  mm) round tip

→ SURFACE

titanium nitride coat

→ TREATMENT

for concrements and biofilm removal in furcations and concavities

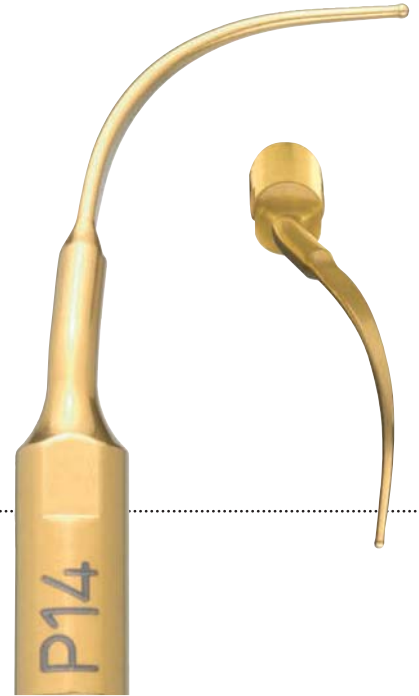



- IDENTIFICATION  
perio
- MORPHOLOGY  
universal curette shape with round surface
- SURFACE  
medical grade stainless steel coat
- TREATMENT  
supra- and subgingival concrements and biofilm removal. Recommended for the treatment of canine and anterior teeth. Debridement of deep periodontal pockets.

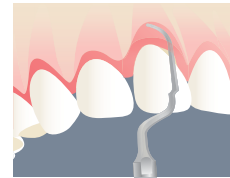
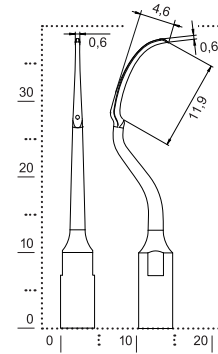

# → P16R

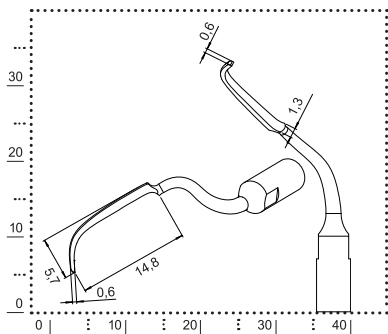

## → IDENTIFICATION

perio

## → MORPHOLOGY

right angled periodontal curette

## → SURFACE

medical grade stainless steel coat

## → TREATMENT

subgingival concretions and biofilm removal from furcations and deep pockets. Recommended for the treatment of molars and premolars.

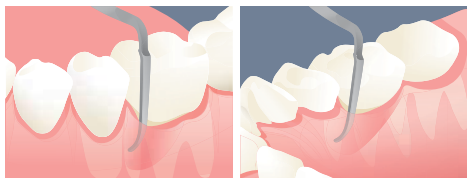



- IDENTIFICATION  
perio
- MORPHOLOGY  
left angled periodontal curette
- SURFACE  
medical grade stainless steel coat
- TREATMENT  
subgingival concretions and biofilm removal from furcations and deep pockets. Recommended for the treatment of molars and premolars.

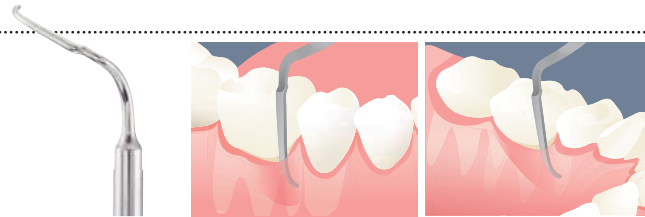
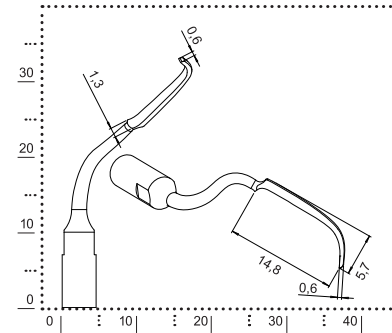

# → ICS + IC1

## → INSERT FOR IMPLANT CLEANING – MAXIMAL TREATMENT EFFICIENCY WITH THE HIGHEST PATIENT COMFORT

- tip IC1 – 100% PEEK (high tech plastics) – for the maximum respect of the implant surface
- the special shape of the tipholder ICS allows an optimal access and a perfect view even in posterior regions
- tipholder ICS and tip IC1 are both sterilisable and reusable

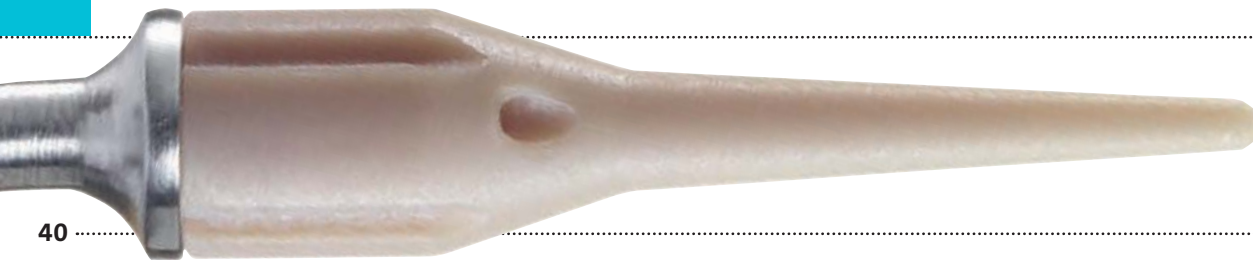

### → IMPLANT CLEANING SET S

The set consists  
of a tipholder ICS  
and 5 tips IC1





→ IDENTIFICATION

perio

→ MORPHOLOGY

102° angled tipholder with conical PEEK tip  
(working length 10 mm, Ø apical 0,8 mm,  
Ø coronal 2 mm)

→ SURFACE

medical grade stainless steel for tipholder ICS  
and 100% PEEK for IC1

→ TREATMENT

efficient and gentle cleaning of implants  
and restorations

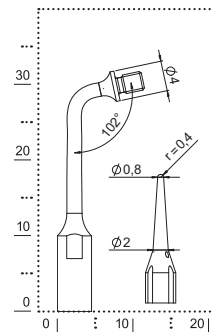

→ ICS

→ IC1



implant cleaning tip IC1  
can be easily tightened  
without special tools  
and is fully autoclavable

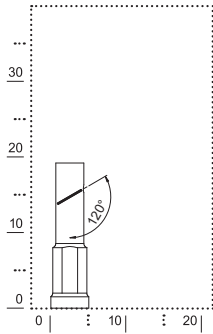

- IDENTIFICATION  
endo
- MORPHOLOGY  
endo files holder 120°
- SURFACE  
titanium nitride coat
- TREATMENT  
front teeth and premolars treatment

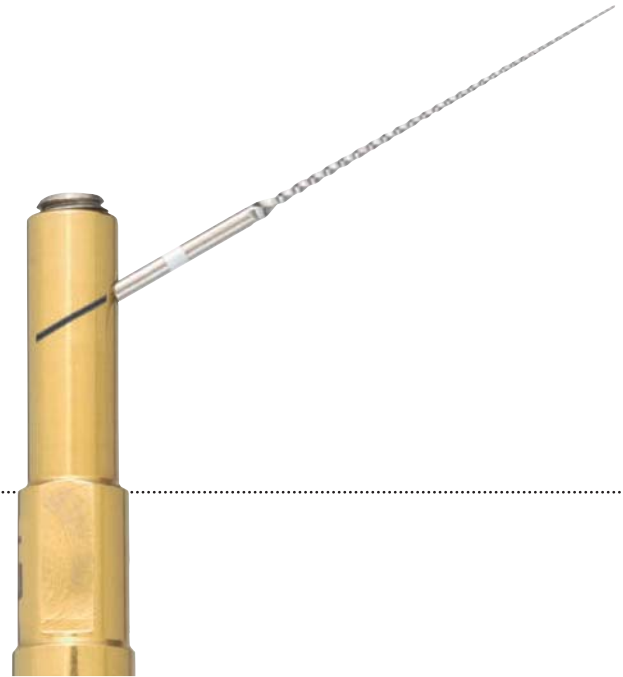

- IDENTIFICATION  
endo
- MORPHOLOGY  
endo files holder 90°
- SURFACE  
titanium nitride coat
- TREATMENT  
molars treatment

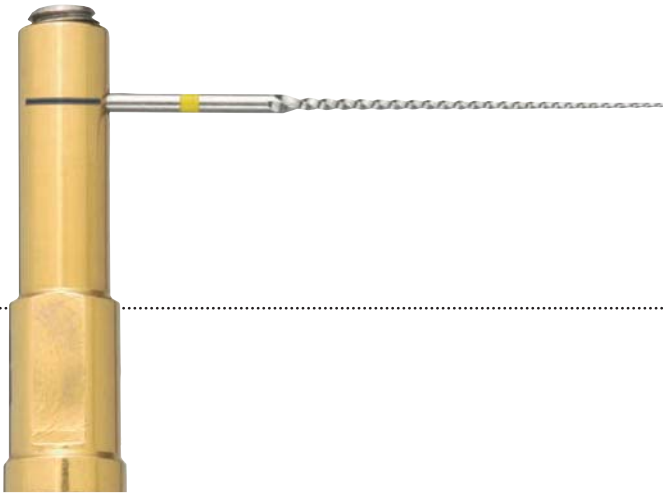
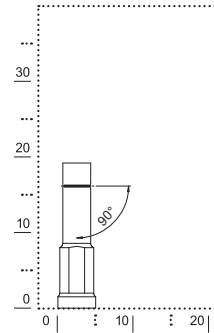

# → ENDO FILES

## → NITI-FILES FOR ULTRASONIC UNITS

ISO 15



ISO 20



ISO 25



→ 27 MM LENGTH

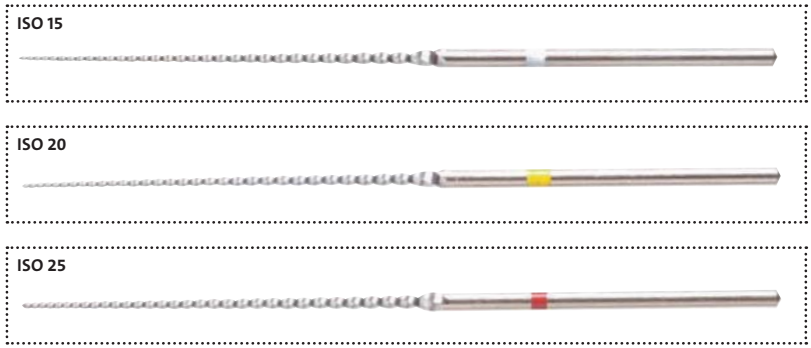

mectron endo files allow a fast root canal preparation for the consequent tridimensional filling treatment.

The liquid irrigation activated by the ultrasonic system arises a double effect:

- the root canal disinfection allowed by a bactericidal effect thanks to the temperature increase of the irrigation liquid
- debris removal (smear layer) generated by an acoustic streaming outcome

→ 31 MM LENGTH

## → ENDO REVISION WITH ER INSERTS

Exposure and removal of root pins, fast and effective removal of calcification in the coronal third of the root, removal of fractured root inserts – the ER inserts cover the complete spectrum of endodontic revision treatment.

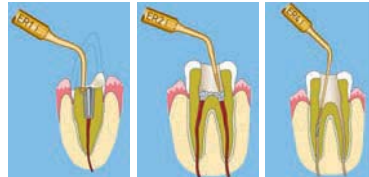



- **IDENTIFICATION**  
endo revision
- **MORPHOLOGY**  
angled shaft with small, spherical ( $\varnothing 1.7$  mm)  
and D30 diamond coated tip
- **SURFACE**  
titanium nitride coat
- **TREATMENT**  
exposure of root canal pins

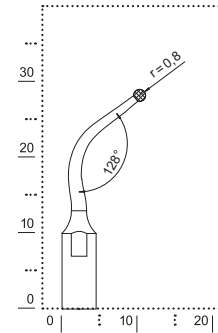

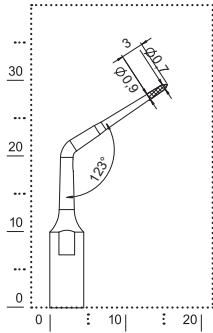

→ IDENTIFICATION

endo revision

→ MORPHOLOGY

angled insert with 0.7 mm  $\varnothing$ , working length up to 10 mm, the last 5 mm D30 diamond coated

→ SURFACE

titanium nitride coat

→ TREATMENT

location of concealed or calcified root canal entrances, removal of restoration materials, calcification and fractured inserts in the coronal third of the root canal







→ IDENTIFICATION

endo revision

→ MORPHOLOGY

angled insert with 0.6 mm  $\varnothing$ , working length up to 10 mm, the last 5 mm D30 diamond coated

→ SURFACE

titanium nitride coat

→ TREATMENT

presentation of calcified root canals entrances, removal of root elements and fractured inserts in the coronal third of the root canal

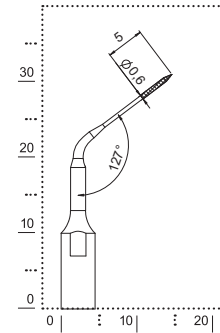

# ER4

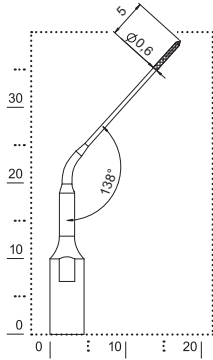

## → IDENTIFICATION

endo revision

## → MORPHOLOGY

angled insert with 0.6 mm  $\varnothing$ , working length up to 20 mm, the last 5 mm D30 diamond coated

## → SURFACE

titanium nitride coat

## → TREATMENT

presentation of calcified root canals entrances, removal of root elements and fractured inserts in the coronal third of the root canal

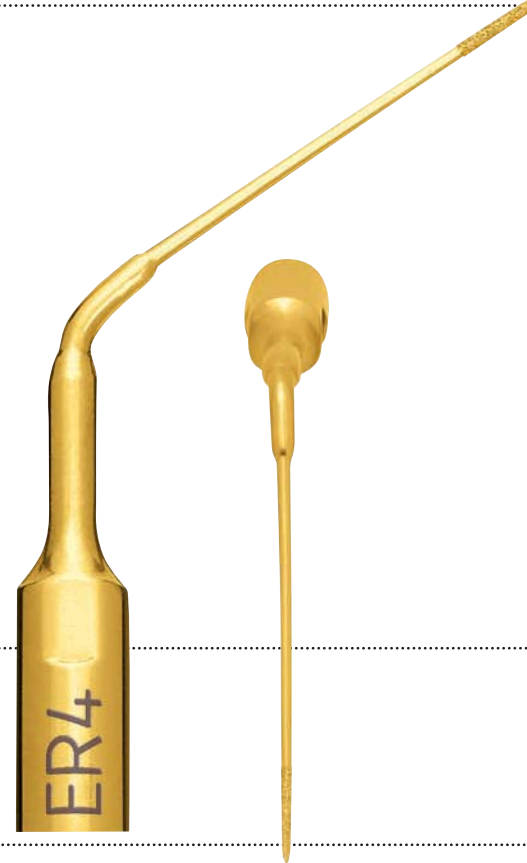

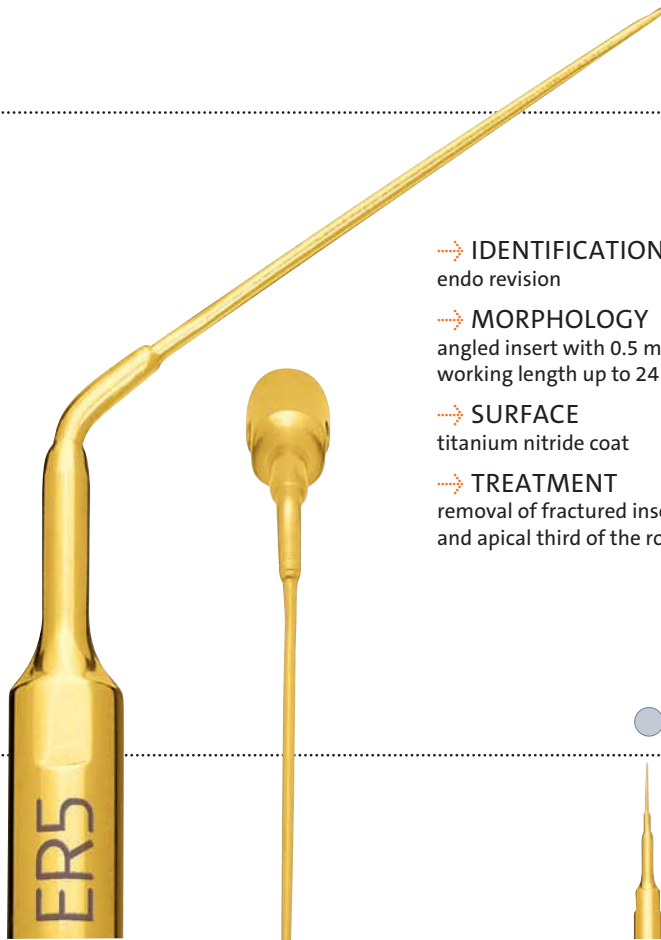

- IDENTIFICATION  
endo revision
- MORPHOLOGY  
angled insert with 0.5 mm  $\varnothing$ ,  
working length up to 24 mm
- SURFACE  
titanium nitride coat
- TREATMENT  
removal of fractured inserts in the medial  
and apical third of the root canal

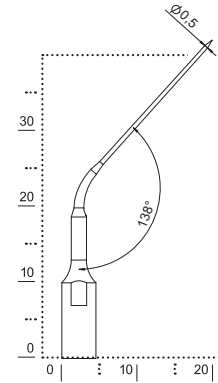

## → ENDO RETRO INSERTS – MINIMALLY INVASIVE RETROGRADE ROOT CANAL PREPARATION

Endo retro inserts assure a satisfying solution to the root canal access issue. Their thin and 90° angled structure allows a conservative cut through a minimum wide bone window.

These advantages facilitate wound healing and spare the patient useless pain.





- IDENTIFICATION  
endo retro
- MORPHOLOGY  
curved insert with a conical round working tip
- SURFACE  
titanium nitride coat
- TREATMENT  
root canal cleaning

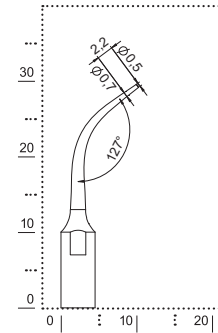

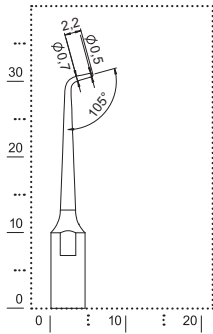

- IDENTIFICATION  
endo retro
- MORPHOLOGY  
long, straight insert with 90° angled working tip
- SURFACE  
titanium nitride coat
- TREATMENT  
root canal cleaning in the frontal area





- IDENTIFICATION  
endo retro
- MORPHOLOGY  
angled shaft, with 90° angled working tip
- SURFACE  
titanium nitride coat
- TREATMENT  
root canal cleaning in the frontal area

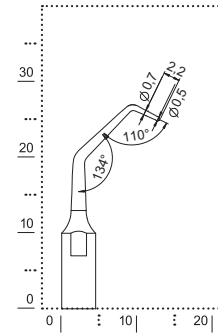

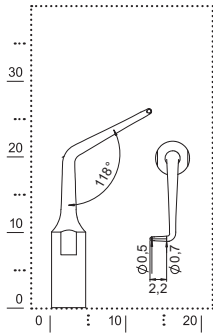

- IDENTIFICATION  
endo retro
- MORPHOLOGY  
angled shaft, with 90° right angled working tip
- SURFACE  
titanium nitride coat
- TREATMENT  
root canal cleaning in the molar area







- IDENTIFICATION  
endo retro
- MORPHOLOGY  
angled shaft, with 90° left angled working tip
- SURFACE  
titanium nitride coat
- TREATMENT  
root canal cleaning in the molar area

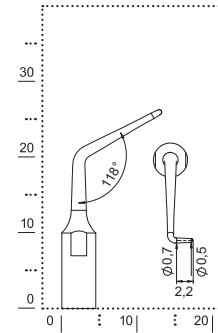

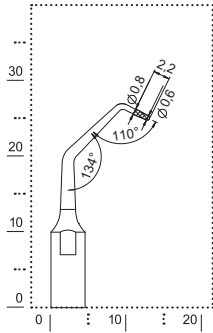

→ IDENTIFICATION

endo retro

→ MORPHOLOGY

angled shaft, with 90° angled working tip and fine diamond coating (D30)

→ SURFACE

titanium nitride coat

→ TREATMENT

root canal cleaning in the frontal area

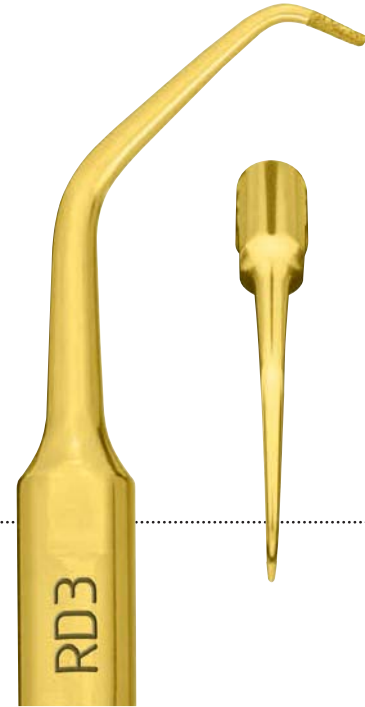

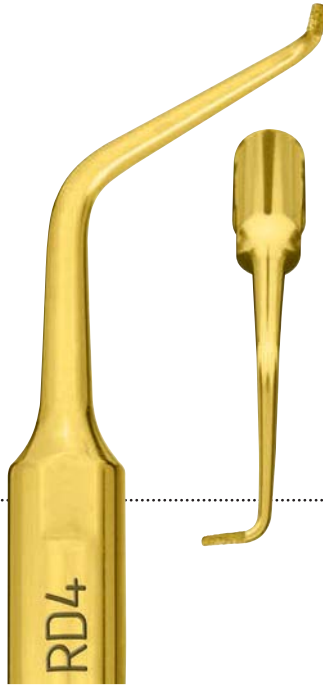

- IDENTIFICATION  
endo retro
- MORPHOLOGY  
angled shaft, with 90° right angled working tip  
and fine diamond coating (D30)
- SURFACE  
titanium nitride coat
- TREATMENT  
root canal cleaning in the molar area

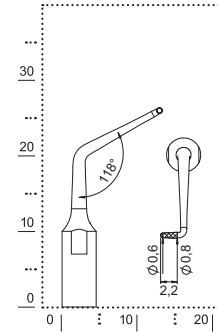

# RD5

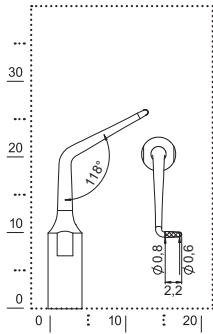

## IDENTIFICATION

endo retro

## MORPHOLOGY

angled shaft, with 90° left angled working tip and fine diamond coating (D30)

## SURFACE

titanium nitride coat

## TREATMENT

root canal cleaning in the molar area

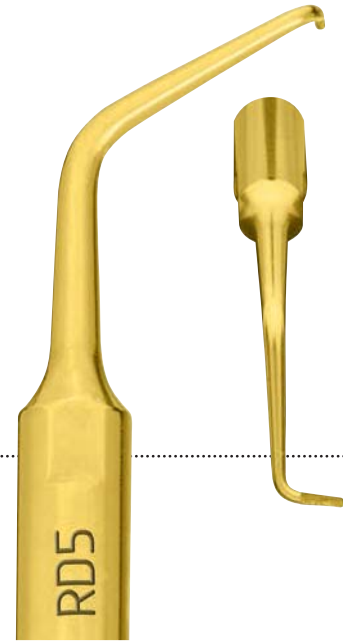



## → EXTRACTION INSERTS – EXCLUSIVE FOR UNITS WITH PULSE MODE

Even if the primary objective of dentistry is the preservation of natural teeth, sometimes extractions cannot be avoided. In these cases, maximum safety is the most important thing during treatment.

The specially shaped inserts ME1, ME2 and ME3 – with a blade thickness of only 0.35 mm – perfectly fulfill the anatomical demands of non surgical extractions. They offer maximum intra-operative sensitivity, allowing a great preservation of alveolar bone and periodontal tissues. Furthermore, the physiological solution guarantees maximum visibility thanks to the cavitation effect which leads to a temporary hemostasis of blood vessels.

→ EXCLUSIVE FOR UNITS WITH PULSE MODE



- IDENTIFICATION  
extractions
- MORPHOLOGY  
double-edged blade with a thickness of only 0.35 mm
- SURFACE  
titanium nitride coat
- TREATMENT  
atraumatic teeth removal

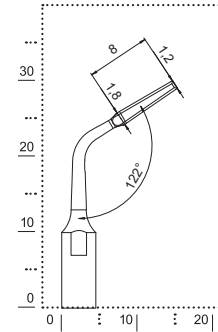

EXTRACTION INSERTS

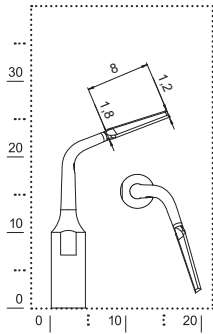

- IDENTIFICATION  
extractions
- MORPHOLOGY  
left angled, double-edged blade  
with a thickness of only 0.35 mm
- SURFACE  
titanium nitride coat
- TREATMENT  
atraumatic teeth removal

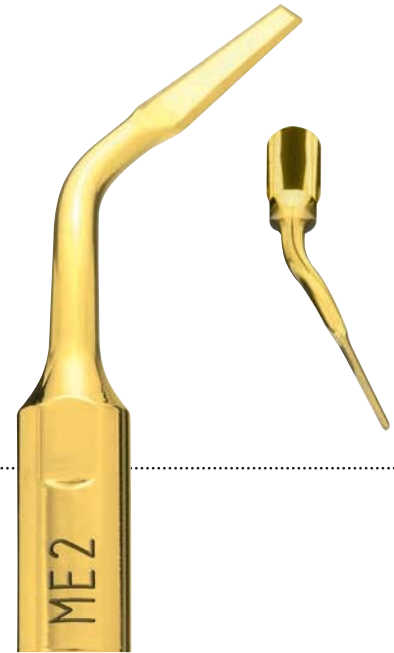



→ EXCLUSIVE FOR UNITS WITH PULSE MODE

→ ME3\*

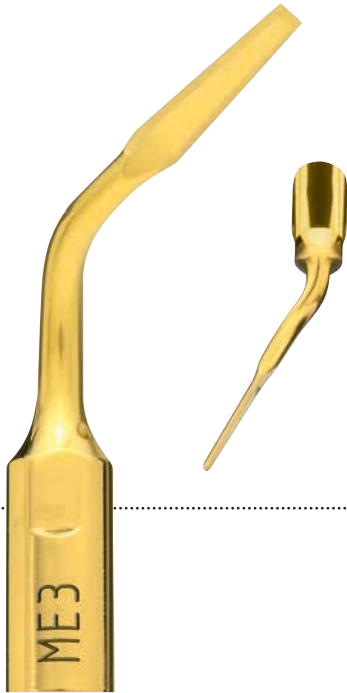

- IDENTIFICATION  
extractions
- MORPHOLOGY  
right angled, double-edged blade  
with a thickness of only 0.35 mm
- SURFACE  
titanium nitride coat
- TREATMENT  
atraumatic teeth removal

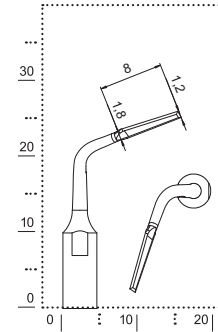

EXTRACTION INSERTS

# CROWN PREP TIPS

## CROWN PREP TIPS – NON-TRAUMATIC AND PRECISE!

The crown prep tips are dedicated to the preparation and finishing of subgingival margins. Due to the particular morphology the tips could be used in contact with the margin without damaging the surrounding soft tissue. The preparation margin could be positioned subgingival with more comfort for the patient.

The special shape of the tipholder allows an optimal view on the preparation field. The tipholder brings the crown prep tips to an elliptic movement and enable therefore a circular preparation of the tooth.



→ TIP HOLDER DB1



→ KEY ABI



→ DYNAMOMETRIC WRENCH K7

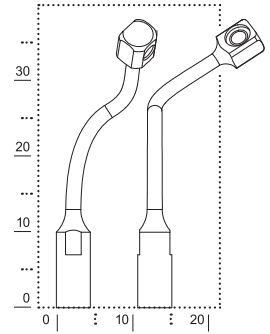

→ TIP HOLDER DB1 WITH CROWN PREP TIP TA14D60

→ LENGTH 10 MM → DIAMOND COATING

diameter	D120	D90	D60
1.2 mm		TA12D90	TA12D60
1.4 mm	TA14D120	TA14D90	TA14D60
1.6 mm	TA16D120	TA16D90	TA16D60

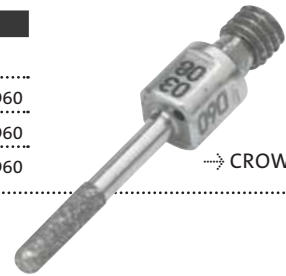

→ CROWN PREP TIP TA14D60

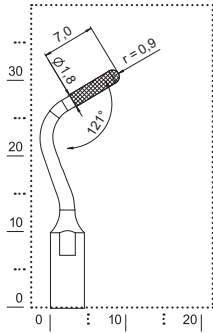

→ IDENTIFICATION

cavity margin

→ MORPHOLOGY

angled shaft with torpedo shaped working tip,  
 $\varnothing$  1.8 mm, medium diamond coating (D91)

→ SURFACE

titanium nitride coat

→ TREATMENT

preparation of the crown core  
 and the crown margin





→ IDENTIFICATION

cavity margin

→ MORPHOLOGY

angled shaft with torpedo shaped working tip,  
 $\varnothing$  1.8 mm, fine diamond coating (D30)

→ SURFACE

titanium nitride coat

→ TREATMENT

fine finishing of the crown core  
 and the crown margin

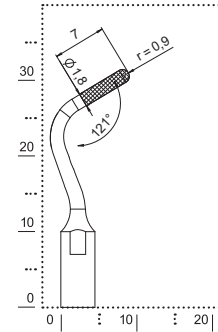

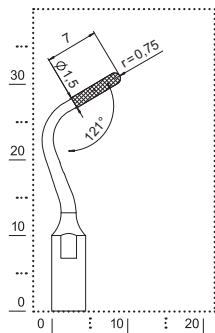

→ IDENTIFICATION

cavity margin

→ MORPHOLOGY

angled shaft with torpedo shaped working tip,  
 $\varnothing$  1.5 mm, medium diamond coating (D91)

→ SURFACE

titanium nitride coat

→ TREATMENT

preparation of the crown core  
 and the crown margin





→ IDENTIFICATION

cavity margin

→ MORPHOLOGY

angled shaft with torpedo shaped working tip,  
 $\varnothing$  1.5 mm, fine diamond coating (D30)

→ SURFACE

titanium nitride coat

→ TREATMENT

fine finishing of the crown core  
 and the crown margin

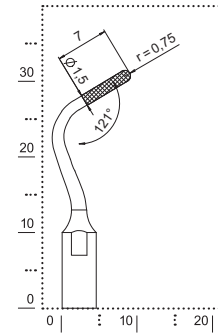

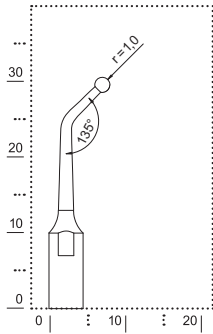

- IDENTIFICATION  
restorative
- MORPHOLOGY  
spherical tip
- SURFACE  
titanium nitride coat
- TREATMENT
  - amalgam condensation in class I, II and V preparations
  - gold fillings burnishing

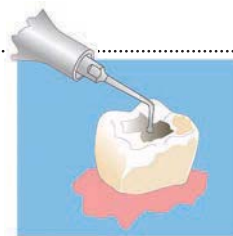





- IDENTIFICATION  
restorative
- MORPHOLOGY  
cylindrical tip
- SURFACE  
titanium nitride coat
- TREATMENT
  - amalgam condensation in class I, II and V preparations
  - crowns and bridges removal

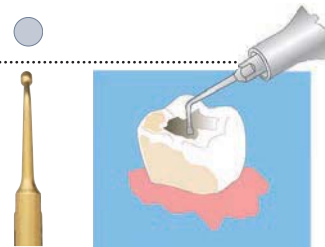
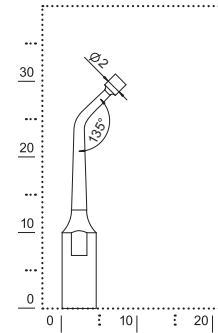

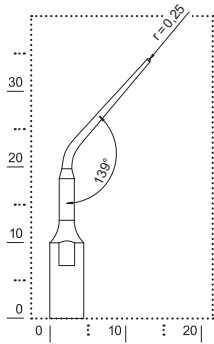

- IDENTIFICATION  
restorative
- MORPHOLOGY  
comparable to a manual spreader
- SURFACE  
titanium nitride coat
- TREATMENT  
lateral condensation of guttapercha

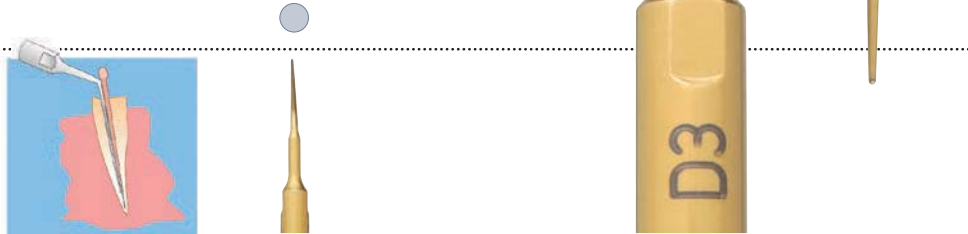

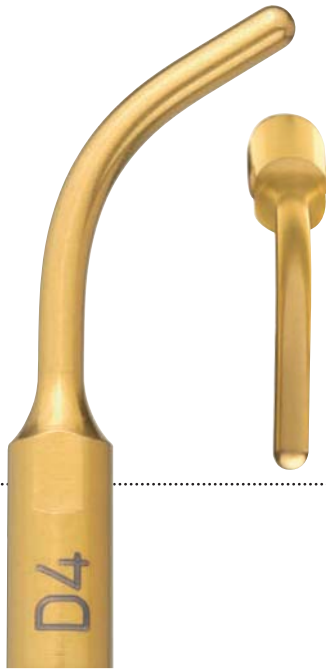



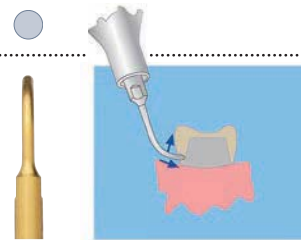
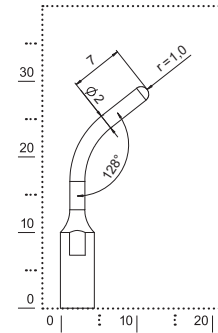

- IDENTIFICATION  
restorative
- MORPHOLOGY  
rounded working tip
- SURFACE  
titanium nitride coat
- TREATMENT  
crowns, bridges and  
metal points removal



# →→→ APPROPRIATE INSERT SETTINGS

	→→ MULTIPIEZO PRO →→ MULTIPIEZO touch →→ MULTIPIEZO white			→→ COMBI touch			→→ PIEZO SMART		→→ MICROPIEZO	→→ COMBI	
											
function	endo	perio/ scaler	restorative prosthetics	endo	perio/scaler	restorative	endo	perio	scaler	power	power
<b>SCALING</b>											
S1-S		1-2 *			1-2 *		1-2			1-2	1-2
S1, S2, S3, S4, S5, S6, S7, S8		4-6			4-5			6-9		4-6	3-4
<b>PERIO</b>											
P1, P2, P3, P4, P10, P11, P12, P13, P14		1-3			3		3-5			1-3	1-2
P15, P16R, P16L		3 *			3 *		3			3	3
<b>IMPLANT CLEANING</b>											
ICS		1			1		1-2	3		1-3	1-2
<b>ENDO</b>											
E1, E2	1-6			1-5			1-2			1-2	1
<b>ENDO REVISION</b>											
ER1		1-6			1-5		3-5	6-9		3-6	2-4
ER2, ER3, ER4, ER5		1-3			1-3		3-5			1-3	1-2

	→ MULTIPIEZO PRO → MULTIPIEZO touch → MULTIPIEZO white			→ COMBI touch			→ PIEZO SMART			→ MICROPIEZO		→ COMBI	
													
function	endo	perio/ scaler	restorative prosthetics	endo	perio/scaler	restorative	endo	perio	scaler	power	power		

#### ENDO RETRO

R1, R2, R3, R4, R5, RD3, RD4, RD5	1-3			1-3			3-5			1-4		1-3	
-----------------------------------	-----	--	--	-----	--	--	-----	--	--	-----	--	-----	--

#### CROWN PREP

DB1	3-6			3-5			3-5			1-3		1-2	
-----	-----	--	--	-----	--	--	-----	--	--	-----	--	-----	--

#### CAVITY MARGIN

CM1, CM2, CM3, CM4	1-5			1-4			3-5 6-8			1-5		1-3	
--------------------	-----	--	--	-----	--	--	---------	--	--	-----	--	-----	--

#### RESTORATIVE

D1, D2, D4	1-6			1-5			6-9			4-6		3-4	
D3	1-5			1-4			6-8			4-6		3-4	

#### EXTRACTION (only for units with restorative/prosthetics function)

ME1, ME2, ME3**	6			5									
-----------------	---	--	--	---	--	--	--	--	--	--	--	--	--

\*\* not available in the United States



# REFERENCE NUMBERS

→ ITEM/REFERENCE NUMBER	
kit scaling	02160001
kit scaling high efficiency	02160005
kit perio universal	02160002
kit perio anatomic	02160006
kit endo	02980020
kit endo revision	02160008
kit endo retro	02160004
kit cavity margin	02160007
kit restorative	02160003
dynamometric wrench K6	02900074
wrench K1	02270003
insert S1-S	02960009
insert S1	02960001
insert S2	02960002
insert S3	02960003
insert S4	02960004
insert S5	02960005
insert S6	02960006
insert S7	02960007
insert S8	02960008
insert P1	02970001
insert P2	02970002
insert P3	02970003
insert P4	02970004
insert P10	03080001
insert P11	03080002
insert P12	03080003

→ ITEM/REFERENCE NUMBER	
insert P13	03080004
insert P14	03080005
insert P15	03080006
insert P16R	03080007
insert P16L	03080008
implant cleaning set S*	02160033
tipholder ICS	03570004
tip IC1 (5 pieces)	02900112
insert E1	02350001
insert E2	02350002
12 x endo file, ISO 15, 31 mm	02730001
12 x endo file, ISO 20,31 mm	02730002
12 x endo file, ISO 25,31 mm	02730003
12 x endo file, ISO 15, 27 mm	02740001
12 x endo file, ISO 20,27 mm	02740002
12 x endo file, ISO 25,27 mm	02740003
insert ER1	03450001
insert ER2	03450002
insert ER3	03450003
insert ER4	03450004
insert ER5	03450005
insert R1	03050001
insert R2	03050002
insert R3	03050003
insert R4	03050004
insert R5	03050005
insert RD3	03050006

→ ITEM/REFERENCE NUMBER	
insert RD4	03050007
insert RD5	03050008
insert ME1	03130001
insert ME2	03130002
insert ME3	03130003
crown prep set**	02160009
tipholder DB1	03570001
key AB1	03580001
dynamometric wrench K7	02900081
crown prep tip TA12D60	03590001
crown prep tip TA14D60	03590002
crown prep tip TA16D60	03590003
crown prep tip TA12D90	03590004
crown prep tip TA14D90	03590005
crown prep tip TA16D90	03590006
crown prep tip TA14D120	03590007
crown prep tip TA16D120	03590008
insert CM1	02190003
insert CM2	02190004
insert CM3	02190001
insert CM4	02190002
insert D1	02990001
insert D2	02990002
insert D3	02990003
insert D4	02990004

\* equipped with: ICS and 5 x IC1

\*\* equipped with: AB1, DB1- + K7

# MECTRON TIP CARD

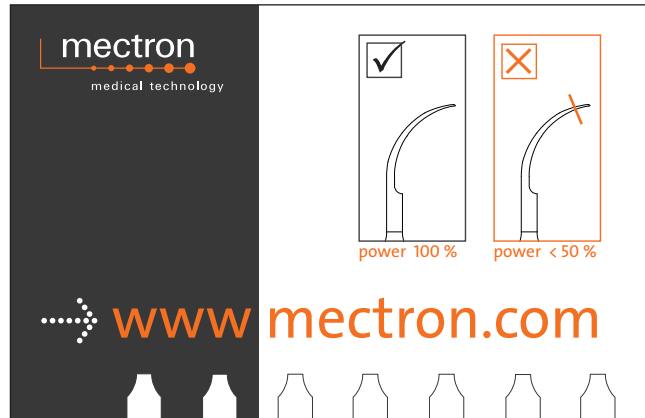
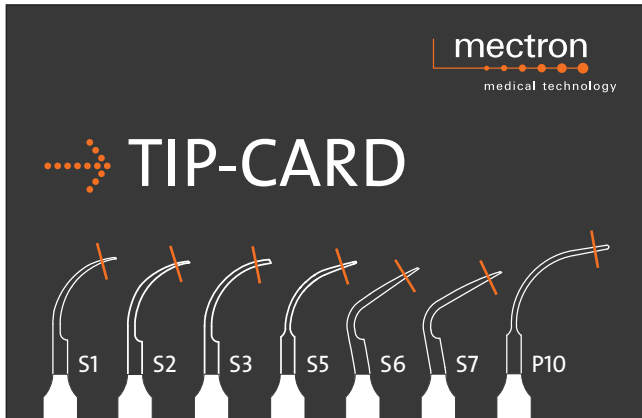

Ultrasonic inserts wear out the same as hand inserts. Regularly check your inserts by means of the erosion tip card. Whenever your inserts are shorter than the orange hatched line, their performance is 50% less than the initial one. Such inserts should be quickly replaced.

mectron s.p.a., via Loreto 15/A,  
16042 Carasco (Ge), Italy,  
tel +39 0185 35361, fax +39 0185 351374

→ [www.mectron.com](http://www.mectron.com) – [mectron@mectron.com](mailto:mectron@mectron.com)

© Copyright mectron S.p.A., Carasco, Italy  
All rights reserved. Texts, pictures and graphics of mectron brochures are protected by copyright  
and other protection laws. Without written approval of mectron S.p.A. the contents may not be  
copied, distributed, changed or made available to third parties for commercial purposes.

