

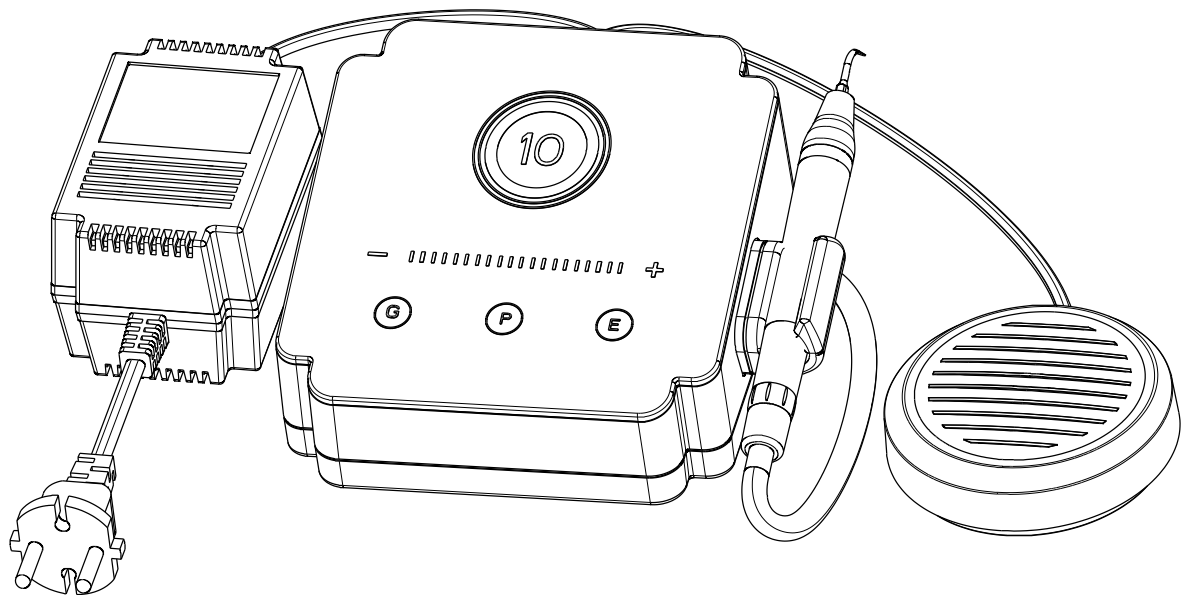

Model: UltraMint



ULTRASONIC SCALER

USER MANUAL

Catalog

1. Overview.....	4
1.1 Content.....	4
1.2 Packing list and coding.....	5
2. Symbol instruction.....	6
3. Foreword.....	8
3.1 Scope of application.....	8
3.2 Contraindications.....	8
4. Installation.....	9
4.1 Front view.....	9
4.2 Back view.....	9
4.3 Installation steps.....	10
4.4 Handpiece installation and removal.....	12
4.5 Tip installation and removal.....	13
5. Product function and use.....	14
5.1 Operation panel instructions.....	14
5.2 Function mode and use.....	15
5.3 Operating the device.....	17
5.4 Advanced settings.....	19
6. Cleaning, Disinfection and Sterilization.....	20
6.1 Foreword.....	20
6.2 General recommendations.....	20
6.3 Autoclavable components.....	20
6.4 Disinfection components.....	25
7. Maintenance.....	26
8. Troubleshooting.....	27
9. Technical Data.....	29
10. EMC Tables.....	30
11. Statement.....	34

1. Overview

1.1 Content

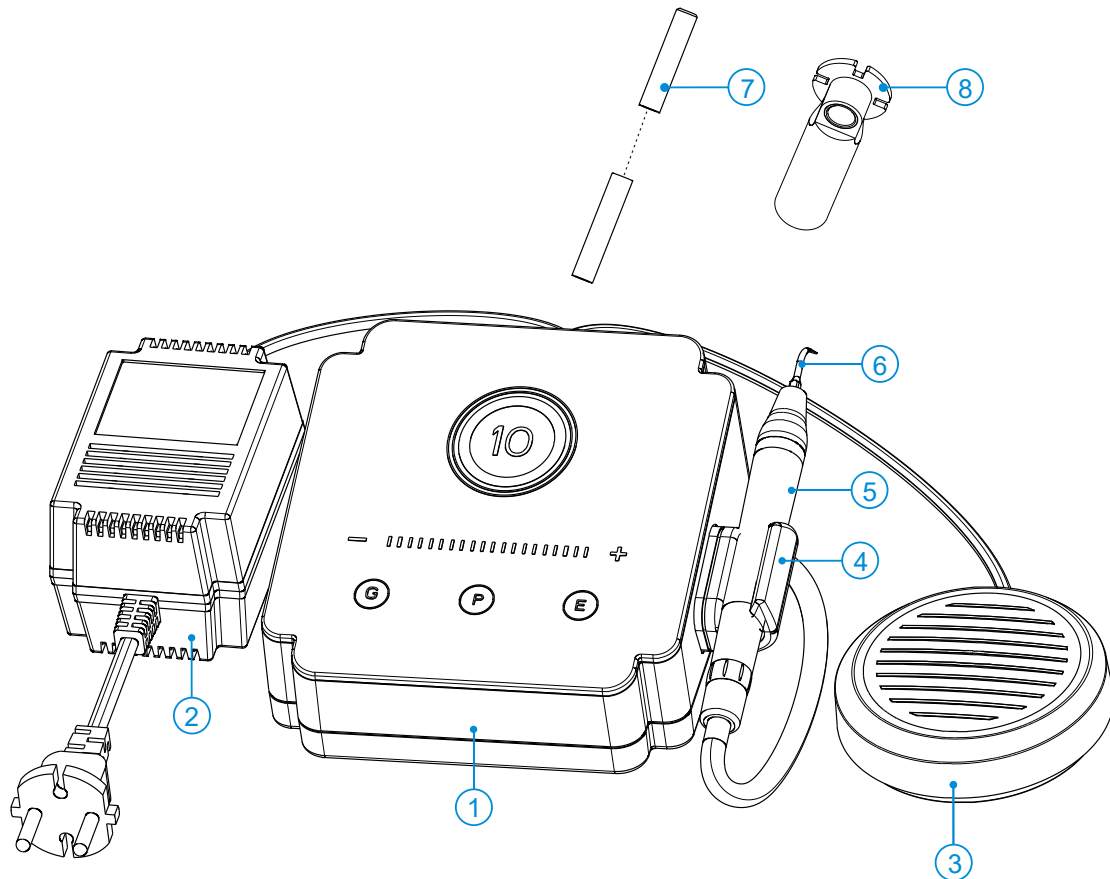





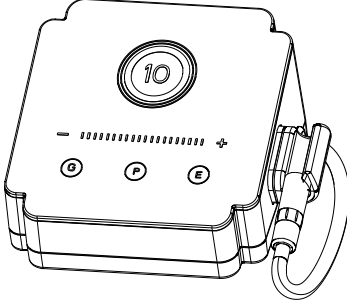
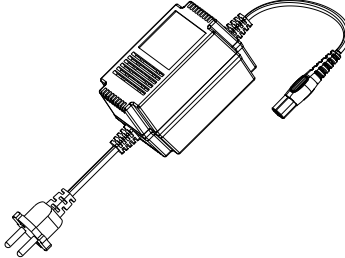
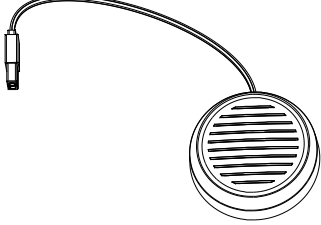
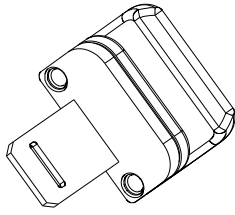
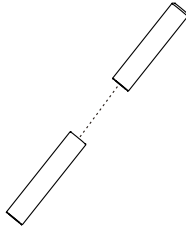
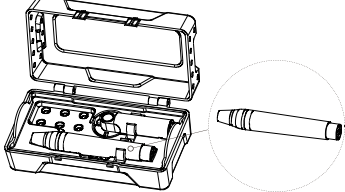
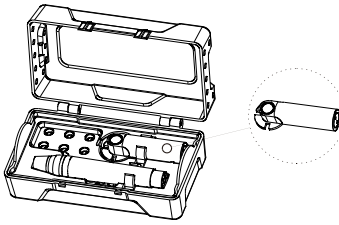
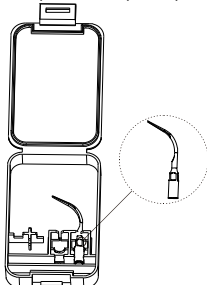
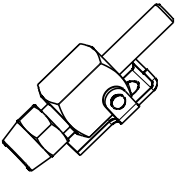

















1. Main Unit
2. Power Adapter
3. Foot Pedal
4. Handpiece Support
5. Handpiece
6. Tip
7. External Water Supply Hose
8. Wrench

1.2 Packing list and coding

<p>Main unit (1 pc) 6651026</p> 	<p>Power adapter (1pc) 6651030</p> 	<p>Foot pedal (1 pc) 6651027</p> 
<p>Handpiece support (1 pc) 6604008</p> 	<p>External water supply hose (1 pc) 6641006</p> 	<p>Handpiece (1 pc) Store in the Instrument Box 6651005</p> 
<p>Wrench (1 pc) Store in the Instrument Box 6651010</p> 	<p>Tips (6 pcs) Store in the following box G1(6626001), G2(6626002), G4(6626004), P1(6626006), P3 (6626007), E4(6626016)</p> 	<p>Note : Optional accessory Hose chuck connector (1 pc) 6651050</p> 

2. Symbol instruction

 WARNING	If the instructions are not followed properly, operation may lead to hazards for the product or the user/patient.
 NOTE	Additional information, explanation of operation and performance.
	Serial number
	Class II equipment
	Type B applied part
	Alternating current
	Dispose of in accordance with the WEEE directive
	Keep dry
	Can be autoclaved up to a maximum temperature of 134° Celsius
	Temperature limitation
	Humidity limitation
	Atmospheric pressure limitation
	Foot Pedal
H_2O 0.01MPa-0.5MPa	Water inlet pressure: 0.01-0.5MPa
IPX0	Ordinary equipment
IPX1	Anti-drip equipment
	Used indoor only
	Catalogue number
	Manufacturer

	Date of manufacture
	Lot of manufacture
	Authorized Representative in the European Community
	Manufacturer's LOGO
	Follow instructions for use
	Washer-disinfector for thermal disinfection

3. Foreword

3.1 Scope of application

UltraMint is an ultrasonic scaler intended for use in dental applications, such as removal of dental calculus and stains, root canal treatment and periodontal therapy.

This device must only be used in hospital environments, clinics or dental offices by trained and qualified dental personnel and not used in the oxygen-rich environment.

3.2 Contraindications

3.2.1 The patient who has hemophilia is not allowed to use in this equipment.

3.2.2 The patient or doctor who equips with cardiac implantable electronic devices is forbidden to use this equipment.

3.2.3 The heart disease patient, pregnant woman and children should be cautious to use the equipment.



Read the following warnings before use:

1. The device must not be placed in humid surroundings or anywhere where it can come into contact with any type of liquids.
2. Do not expose the device to direct or indirect heat sources. The device must be operated and stored in a safe environment.
3. The device requires special precautions with regard to electromagnetic compatibility (EMC) and must be installed and operated in strict compliance with the EMC information. In particular, do not use the device in the vicinity of fluorescent lamps, radio transmitters, remote controls and do not use this system near the active HF Surgical Equipment in the hospital. Portable RF communications equipment (including peripherals such as antenna cables and external antennas) should be used no closer than 30 cm (12 inches) to any part of the ultrasonic scaler, including cables specified by the manufacturer. Otherwise, degradation of the performance of this equipment could result. Do not charge, operate or store at high temperatures. Comply with the specified operating and storage conditions.
4. Gloves are compulsory during treatment.
5. If irregularities occur in the device during treatment, switch it off. Contact the agency.
6. Never open or repair the device yourself, otherwise, void the warranty.

4. Installation

4.1 Front view

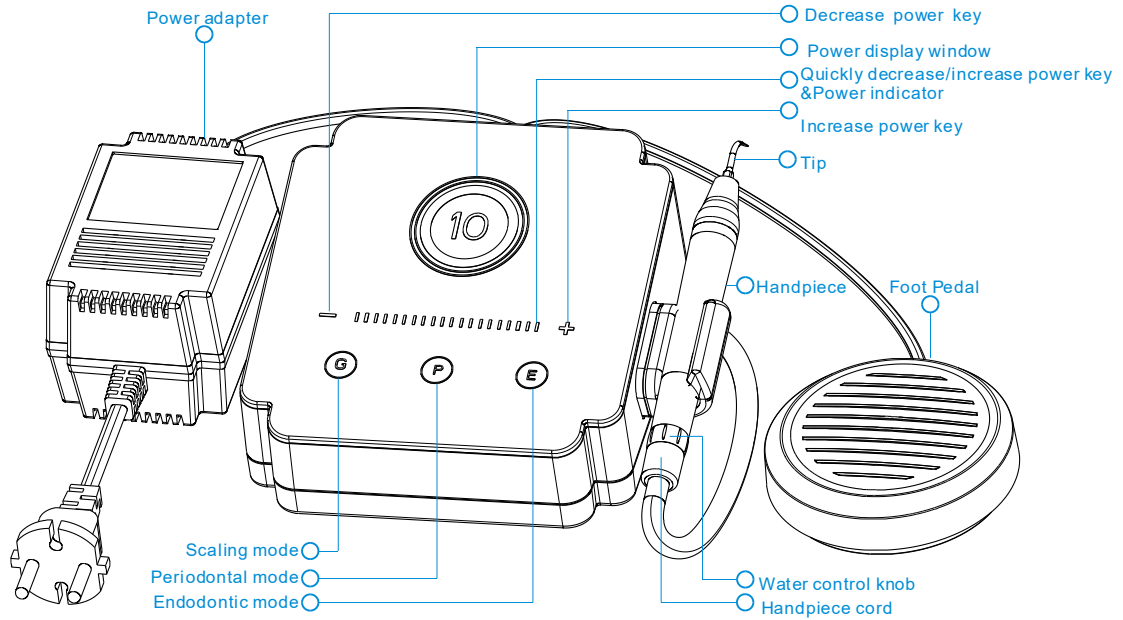

4.2 Back view

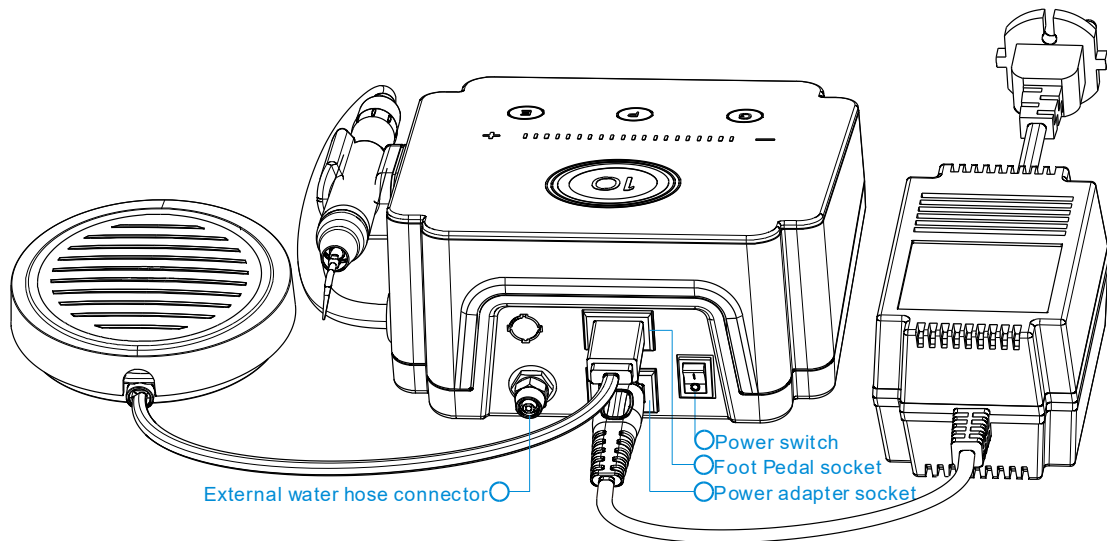

4.3 Installation steps

4.3.1 Install the handpiece support

Install the handpiece support to the main unit first.

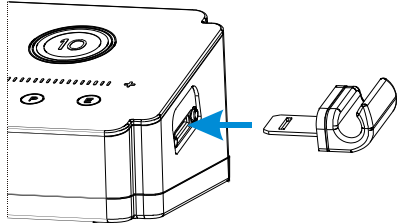

Clamp the handpiece cord to the hanpiece support.

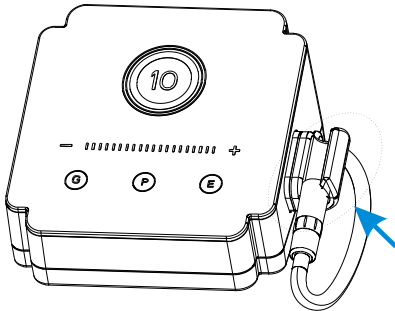

4.3.2 Install power adapter and foot pedal

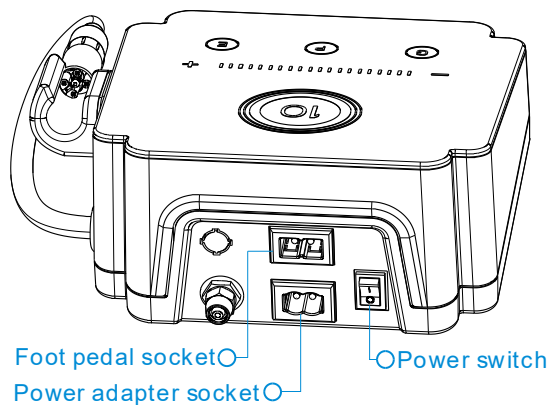

As shown in the figure, plug the power adapter and foot pedal into the corresponding sockets. Turn the power switch to the off state (press the side marked "O" on the switch), and insert the adapter power plug into

the power supply to supply power to the main unit.



WARNING

- The power adapter must be plugged into the main unit before being plugged into the power supply.

4.3.3 Install external water supply hose

Install the external water supply hose to the external water hose connector on the main unit as shown below.

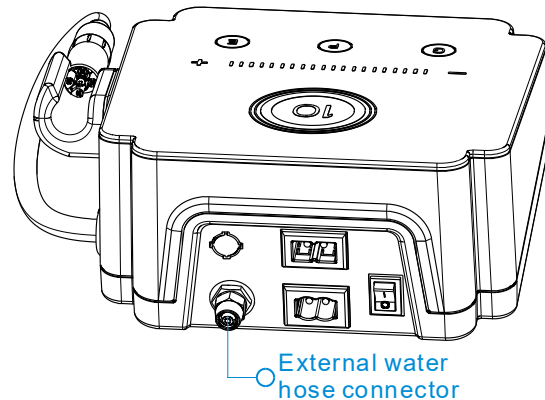

- 1) Unscrew the lock nut on the external water hose connector counterclockwise.
- 2) Put the lock nut on the external water supply hose.
- 3) Insert the external water supply hose to the external water hose connector.
- 4) Tighten the lock nut clockwise to complete the installation of the external water supply hose.
- 5) Connect the other end of the external water supply hose to the clean water source.
- 6) See the next page for installation diagram.

**WARNING**

The water source pressure should be in the range of 0.01-0.5MPa.

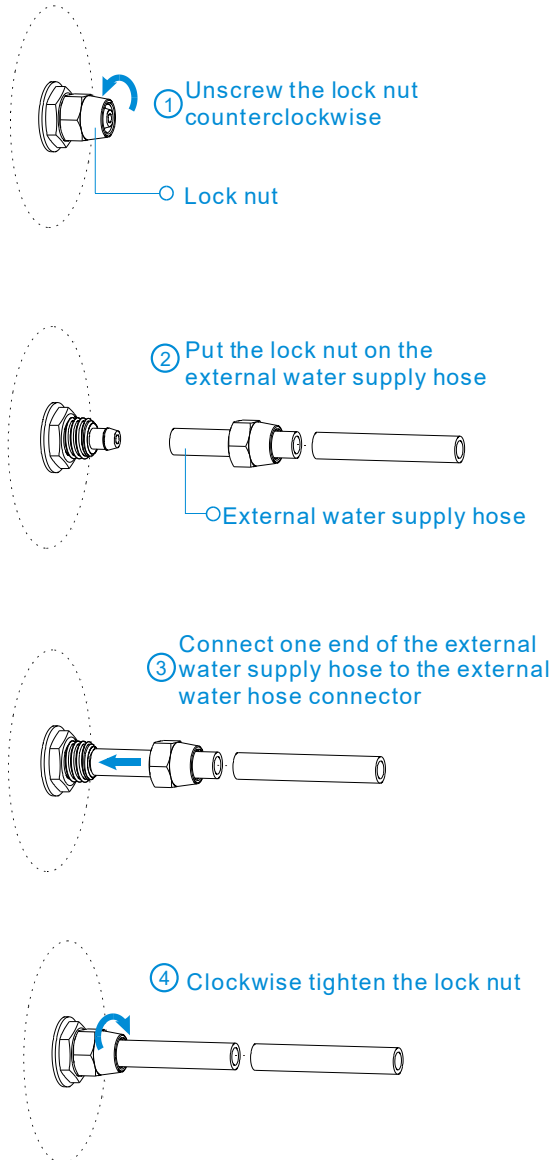

4.4 Handpiece installation and removal

4.4.1 Handpiece installation and removal

Install and remove the handpiece as shown below.

Note that before installation, align the direction mark on the handpiece with the direction mark on the connector of handpiece cord, and then insert the handpiece into the connector of the handpiece cord.

Installation

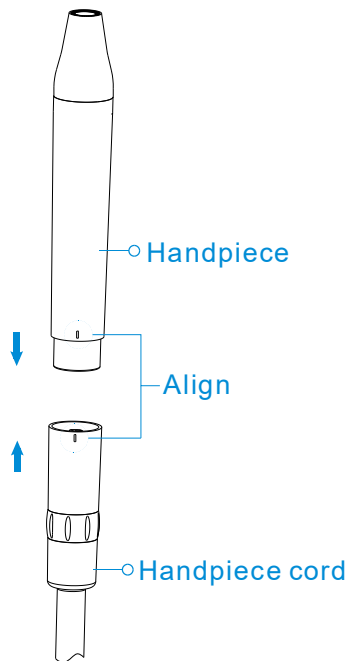

Removal

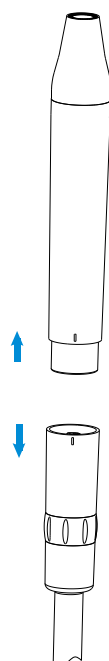

4.4.2 Lamp bead protective shield and light guide and lamp bead removal and installation



WARNING

Disassemble the light guide and lamp bead from the handpiece, before Cleaning, disinfection and sterilization handpiece.

Removal

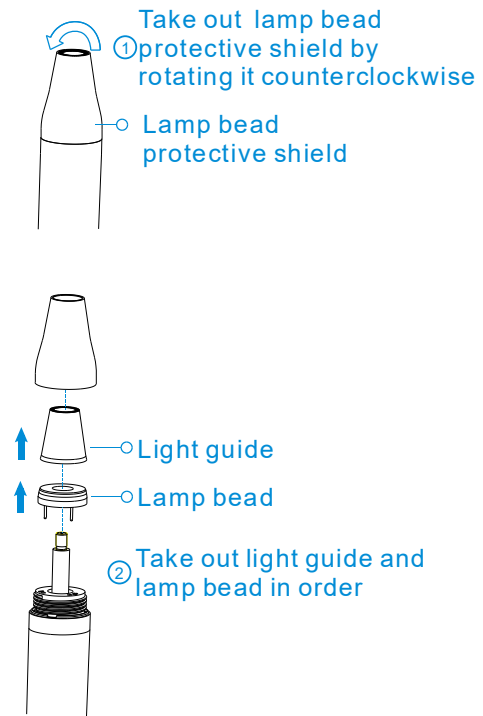

Installation

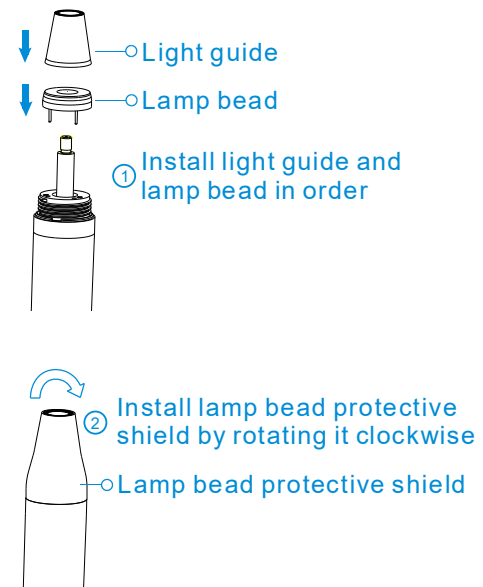

4.5 Tip installation and removal

4.5.1 Tip installation

- 1) Screw the tip to the handpiece.
- 2) Align the gap of the wrench with the tip.
- 3) Rotate the wrench clockwise until it turns 90 degrees.

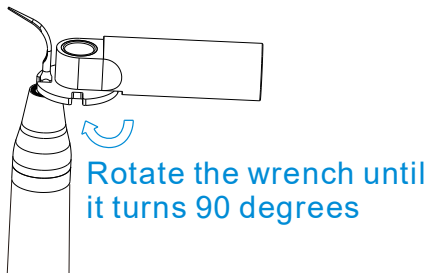
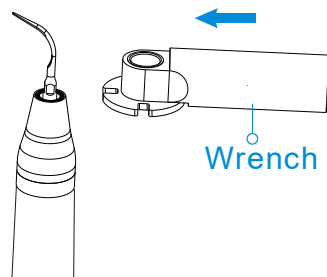
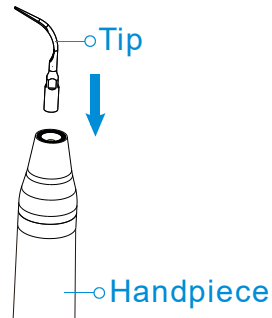

NOTE

1. Pay attention to the gap of the wrench.

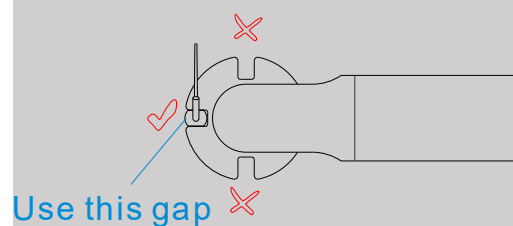

4.5.2 Tip removal

- 1) Align the gap of the wrench with the tip.
- 2) Rotate the wrench counterclockwise until the tip becomes loose.
- 3) Unscrew the tip from the handpiece

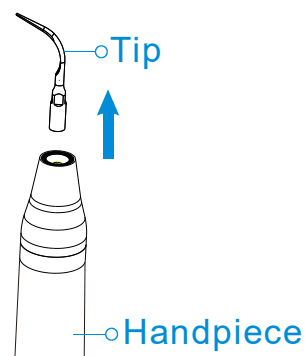
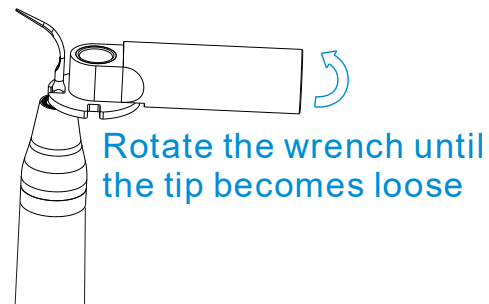
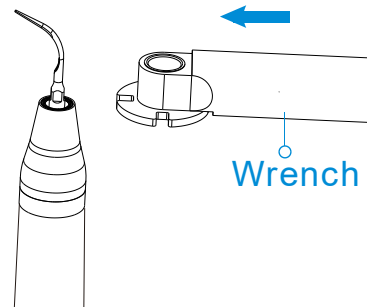

5. Product function and use

5.1 Operation panel instructions

5.1.1 Working mode

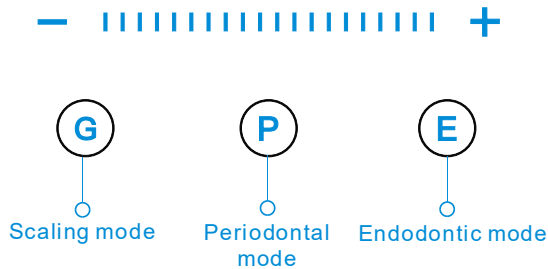

This equipment can provide three working modes: Scaling mode, periodontal mode and endodontic mode.

Press the “G” key to select the scaling mode, the indicator on the corresponding button is lit, select the tip marked with "G" at the tip when using it.

Press the “P” key to select the periodontal mode, the indicator on the corresponding button is lit, select the tip marked with "P" at the tip when using it.

Press the “E” key to select the endodontic mode, the indicator on the corresponding button is lit, select the tip marked with "E" at the tip when

5.1.2 Power adjustment

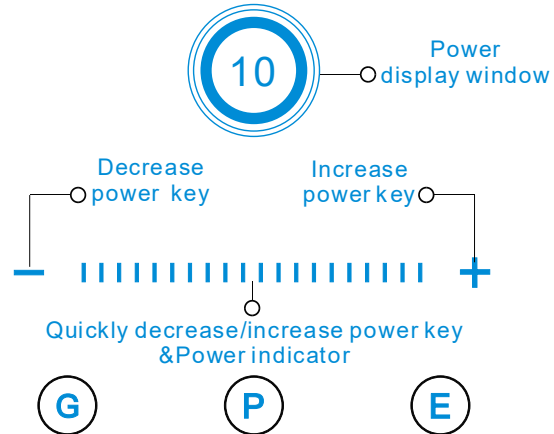

The device can provide 10 (1-10) graduations of power configurations in each mode, and the user can adjust it according to the needs of use.

Press "-" key to decrease the power, press "+" key to increase the power.

"10" Power display window" and "15 power indicator" correspond to the power level.

Users can also adjust the power by tapping with their fingers or sliding "15" left and right.

using it.	
-----------	--

5.2 Function mode and use

Water supply function and use	
--------------------------------------	--

Connect the other end of the external water supply hose to the connector that can provide water for the device.	
---	--

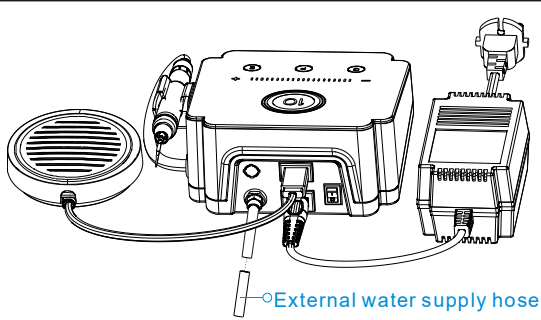

Water flow adjustment

Adjust the water flow through the water control knob on the handpiece cord.

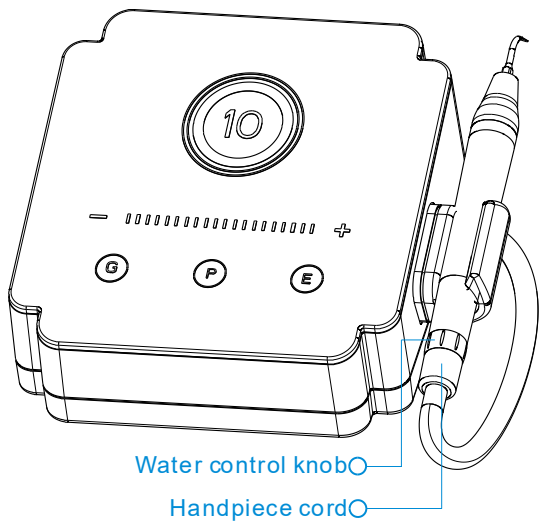

5.3 Operating the device

<p>5.3.1 Install the device correctly according to the installation steps. The operator is facing the device, and the water control knob on the handpiece cord is adjusted to the maximum.</p> <p>5.3.2 Press the power switch on the main unit. At this time, the scaling mode  indicator is lit, the power display window shows 05, the power indicator lights half.</p> <p>5.3.3 Select the appropriate working tip as required, and tighten it to the handpiece by using the provided wrench.</p> <p>5.3.4 Hold the handpiece according to the using habits, generally adopt the pen holding position.</p> <p>5.3.5 When the device is working normally, the frequency is extremely fast. When scaling, ensure that the tip vibrates normally and the water is atomized normally, then gently touch the tooth surface and reciprocate at a certain speed to remove the dental calculus. Keep the water flow smoothly to avoid tip overheat. Never use excessive force or stay for too long when cleaning the teeth.</p> <p>5.3.6 Power adjustment: Adjust the power depending on the application. Generally, the medium power is enough, and the output power can be adjusted at any time in clinical practice according to the</p>	<p>sensitivity of the patient's teeth and the hardness of calculus.</p> <p>5.3.7 Water flow adjustment: Step on the foot pedal to activate the tip vibration. Turn the water control knob on the handpiece cord to form water spray to cool the tip and the cleaned tooth surface.</p> <p>5.3.8 During clinical use, the cusp of the tip should not be in vertical contact with the tooth surface, and heavy pressure should not be applied in order to avoid damage to the tooth and the tip.</p> <p>5.3.9 After the operation is completed, adjust the water flow of the handpiece to the maximum, let the device work for about 30 seconds to rinse the handpiece and the tip, and then remove the handpiece and the tip for cleaning, disinfection and sterilization.</p>
--	---

**NOTE**

1. Keep the device clean before and after use.
2. Before each use, always check that the device is placed on a secure and flat surface. And adjust the water flow to the maximum, and then start the device to work for about 10 seconds in order to eliminate the residual liquid in the liquid circuit.
3. The operator should take sufficient protection (such as wearing goggles, face mask, etc.) to prevent cross infection. Use of an antiseptic mouth rinse prior to procedure and use of a high volume evacuator during the scaling procedure are recommended.
4. The use of the product must meet the requirements of the relevant operating specifications and relevant regulations of the treatment department, and is limited to the use of trained professionals (such as dentists) in the hospital or clinic.
5. Do not screw the tip or pull out the handpiece while the machine is running.
6. The tip must be tightened and there must be fine spray coming out from the tip when operating. Refer to the user manual of tips for detailed operating instructions.
7. Change a new one when the tip or handpiece is damaged or there are visible signs of wear.
8. Do not twist or rub the tip.
9. Do not use impure water sources, and never use saline instead of pure water.
10. If use the water source without hydraulic pressure, the water surface should be 1 meter higher than the head of the patient.
11. Do not pull the handpiece cord with force to avoid damage to the tail wire.
12. Do not knock or rub the handpiece.
13. After operating, turn off the power switch and pull out the power plug.
14. Always use original parts. Using non original instruments may damage the device, and operator or patient may be injured.
15. No modification shall be made on this product.
16. The ultrasound power must be adjusted in accordance with the tip used and the required treatment.
17. Always check that the cords or cables will not rub against the front face during the operation since this could eventually modify the selected settings.

5.4 Advanced settings

5.4.1 "Cleaning" mode

It is recommended to flush the liquid circuit of the device after scaling at least once a day. The "Cleaning" mode allows for cleaning the liquid circuit in order to reduce the accumulation of crystals and bacteria in the liquid circuit.

Steps:

- 1) Install the water hose to the water inlet correctly.
- 2) Press and hold "P" and "E" at the same time for about 2 seconds. At this time, the buzzer beeps once and enters the "Cleaning" mode. At this time, the LED digital tube on the panel alternately displays "CL" and cleaning time. The default cleaning time is 30 Seconds, press "+" or "-" key to adjust. The adjustment range is 10 ~ 60 seconds.
- 3) Step on the foot pedal to start cleaning the liquid circuit. At this time, the foot pedal can be released.
- 4) After the cleaning countdown, the device will automatically stop and exit the "Cleaning" mode. During the cleaning process, step on the foot pedal again or press the "G" key to stop cleaning and exit the "Cleaning" mode.

5.4.2 Handpiece LED light delay adjustment

The handpiece LED light will be lit during the operation. The device will stop running after the foot pedal is released. The handpiece LED light will be delayed for a certain time before extinguishing. The default delay time is 10 seconds, and the delay time can be adjusted as needed.

Steps:

Press and hold the "P" key and the "E" key at the same time for about 2 seconds, at this time the, the buzzer beeps once and enter the "Cleaning" mode, and then press the "E" key to enter the handpiece LED light adjustment state, at this time, the LED digital tube display the delay time. The default is 10 seconds, you can press the "+" or "-" key to proceed adjustment. The adjustment range is 10 ~ 20 seconds. Press the "G" button or no operation for about 5 seconds to exit the setting of the handpiece LED light delay.

6. Cleaning, Disinfection and Sterilization

6.1 Foreword

The parts for clinical application contamination are the outer surfaces of the handpiece, tip and wrench. For hygiene and sanitary safety purpose, these components must be cleaned, disinfected and sterilized before each usage to prevent any contamination. This concerns the first use as well as the subsequent uses. Comply with your national guidelines, standards and requirements for cleaning, disinfection and sterilization.

Reprocessing procedures have only limited implications to these dental instruments. The limitation of the numbers of reprocessing procedures is therefore determined by the function / wear of the device. From the processing side there is no maximum number of allowable reprocessing. The device should no longer be reused in case of signs of material degradation.

In case of damage, the device should be reprocessed before sending back to the manufacturer for repair.

6.2 General recommendations

- The user is responsible for the sterility of the product for the first cycle and each further usage as well as for the usage of damaged or dirty instruments, where applicable after sterility.
- For your own safety, please wear personal protective equipment (gloves, safety glasses, etc.).
- Use only a disinfecting solution which is approved for its efficacy (VAH/DGHM-listing, CE marking, and FDA approval) and in accordance with the DFU of the disinfecting solution manufacturer.
- The water quality has to be convenient to the local regulations especially for the last rinsing step or with a washer-disinfector.
- Thoroughly clean and wash the components before autoclaving.
- Do not use bleach or chloride disinfectant materials.

6.3 Autoclavable components

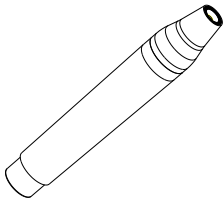
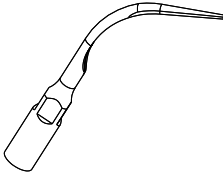
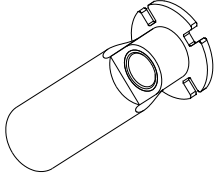
Autoclavable Components		
Handpiece 	Tip 	Wrench 



**WARNING**



- Only the components above can be autoclaved.
- Before first use and after each use, sterilize the above components.

Reprocessing Instructions

Preparation at the Point of Use:	<p>Before cleaning, disconnect the handpiece and tips from the main unit. Disassemble the light guide and lamp beads from the handpiece. Refer to Chapter 4.4 and 4.5 of this manual for disassembly instructions. Remove gross contaminations from the components with code water (<math><40^{\circ}\text{C}</math>) immediately after use. Don't use a fixating detergent or hot water (>math>>40^{\circ}\text{C}</math>) as this can cause the fixation of residuals which may influence the result of the reprocessing process.</p> <p>Store the instruments in a humid surrounding.</p> <div data-bbox="544 887 608 936" data-label="Image"> </div> <div data-bbox="608 902 715 927" data-label="Section-Header">WARNING</div> <p>Do not submerge the components or wipe them with any of the following functional water (acidic electrolyzed water, strong alkaline solution, or ozone water), medical agents (glutaral, etc.), or any other special types of water or commercial cleaning liquids. Such liquids may result in metal corrosion and adhesion of the residual medical agents to the components.</p>
Transportation:	<p>Safe storage and transportation to the reprocessing area to avoid any damage and contamination to the environment.</p>
Preparation for Decontamination:	<p>The devices must be reprocessed in a disassembled state.</p> <div data-bbox="544 1480 608 1529" data-label="Image"> </div> <div data-bbox="608 1496 715 1520" data-label="Section-Header">WARNING</div> <p>Observe suitable personal protective measures.</p>
Pre-Cleaning:	<p>Do a manual pre-cleaning, until the components are visually clean. Submerge the components in a cleaning solution and flush the lumens with a water jet pistol with cold tap water for at least 10 seconds. Clean the surfaces with a soft bristle brush.</p>
Cleaning:	<p>Regarding cleaning/disinfection, rinsing and drying, it is to distinguish between manual and automated reprocessing methods. Preference is to be given to automated reprocessing methods, especially due to the better standardizing potential and industrial safety.</p>

	<p>Automated Cleaning:</p> <p>Carefully put the components into the washer-disinfector on a tray and set the parameters as follows, then start the program:</p> <ul style="list-style-type: none"> • 4 min pre-washing with cold water (<40°C); • emptying • 5 min washing with a mild alkaline cleaner at 55°C; • emptying • 3 min neutralizing with warm water (40°C); • emptying • 5 min intermediate rinsing with warm water (40°C); • emptying <p><i>The automated cleaning processes have been validated by using 0.5% neodisher MediClean forte (Dr. Weigert).</i></p> <p>Note Acc. to EN ISO 17664 no manual reprocessing methods are required for these devices. If a manual reprocessing method has to be used, please validate it prior to use.</p> <div style="background-color: #e0e0e0; padding: 5px;">  WARNING <ul style="list-style-type: none"> ● Use only approved washer-disinfectors according to EN ISO 15883, maintain and calibrate it regularly. ● Follow instructions and observe concentrations given by the manufacturer (see general recommendations). </div>
Disinfection:	<p>Automated Thermal Disinfection in washer/disinfector under consideration of national requirements in regards to A0 value (see EN ISO 15883).</p> <p>A disinfection cycle of 5 min disinfection at 93°C has been validated for the device to achieve an A0 value of 3000.</p> <p>After cleaning, the instruments should be automated disinfected immediately. A manual disinfection is not recommended. Please use fully demineralized water.</p>
Drying:	<p>Automated Drying:</p> <p>Drying the instruments according to drying cycle of washer/disinfector. If needed, additional manual drying can be performed through lint free towel. Insufflate cavities of instruments by using sterile compressed air.</p>

Functional Testing, Maintenance:	<p>Visual inspection for cleanliness of the instruments and reassembling. Functional testing according to instructions of use. If necessary, perform reprocessing process again until the instrument is visibly clean.</p> <p>Before packaging and autoclaving, make sure that the components have been maintained according to the manufacturer's instruction.</p>
Packaging:	<p>Pack the instruments in an appropriate packaging material for sterilization.</p> <div style="background-color: #f0f0f0; padding: 10px;">  WARNING <ul style="list-style-type: none"> ● Check the validity period of pouch given by the manufacturer to determine the shelf life. ● Use pouches which resist to a temperature up to 141°C and in accordance with EN ISO 11607. </div>
Sterilization:	<p>Sterilization of instruments by applying a fractionated pre-vacuum steam sterilization process (according to EN 285/EN 13060/EN ISO 17665) under consideration of the respective country requirements.</p> <p>Minimum requirements: 5 min at 134 °C. Maximum sterilization temperature: 137°C. Drying time: at least 8min.</p> <p>Flash sterilization is not allowed on lumen instruments!</p> <div style="background-color: #f0f0f0; padding: 10px;">  WARNING <ul style="list-style-type: none"> ● Use only approved autoclave devices according to EN 13060 or EN 285. ● Use a validated sterilization procedure according to EN ISO 17665. ● Respect the maintenance procedure of the autoclave device given by the manufacturer. ● Use only this recommended sterilization procedure. ● Control the efficiency (packaging integrity, no humidity, color change of sterilization indicators, physicochemical integrators, digital records of cycles parameters). ● The sterilization procedure must comply with EN ISO 17665. </div>

	<ul style="list-style-type: none"> ● Waiting for cooling before touching.
Storage:	<p>Storage of sterilized instruments in a dry, clean and dust free environment at modest temperatures, refer to label and instructions for use.</p> <p> WARNING</p> <ul style="list-style-type: none"> ● Sterility cannot be guaranteed if packaging is open, damaged or wet. ● Check the packaging before using it (packaging integrity, no humidity and validity period).
Reprocessing validation study information:	<p>The above-mentioned reprocessing process (cleaning, disinfection, sterilization) has been successfully validated. Refer to cleaning/disinfection validation reports No. RDS2020D0073 001, RDS2020D0076 001 and RDS2020D0075 001; sterilization validation reports No. RDS2020S0081 001, RDS2020S0084 001 and RDS2020S0083 001.</p>
<p> NOTE</p> <ul style="list-style-type: none"> ● Before sterilization, please remove the tip. ● Make sure that the handpiece is intact and not damaged before sterilization or use, and do not apply any protective oil on the handpiece. ● The two O-rings on the handpiece cord (and the handpiece insertion point) will be subject to force and wear during insertion and removal. Users can apply dental lubricant to the O-ring in daily use. If the O-ring is damaged or severely worn, causing water leakage or loose connection, please replace the O-ring. ● The instructions provided above have been validated by the manufacturer of the medical device as being capable of preparing a medical device for use. It remains the responsibility of the processor to ensure that the processing, as actually performed using equipment, materials and personnel in the processing facility, achieves the desired result. This requires verification and/or validation and routine monitoring of the process. Likewise, any deviation by the processor from the instructions provided should be properly evaluated for effectiveness and potential adverse consequences. 	

6.4 Disinfection components

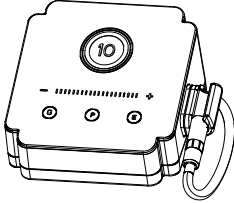
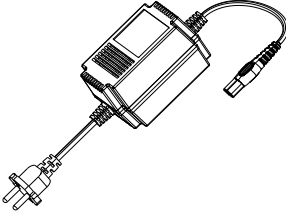
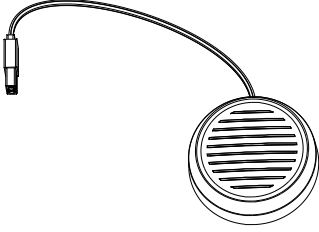
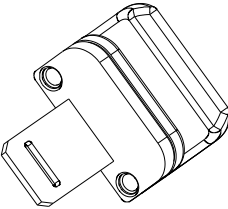
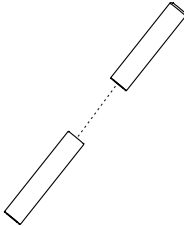
Disinfection components		
Main unit 	Power adapter 	Foot pedal 
Handpiece support 	External water supply hose 	
<p>Wipe all the surfaces with a cloth lightly moistened with Ethanol for Disinfection (Ethanol 70 to 80 vol%) at least 2min, repeat for 5 times.</p>		
<p>! NOTE</p> <ul style="list-style-type: none"> ● Do not use anything except Ethanol for Disinfection (Ethanol 70 to 80 vol%). ● Do not use too much ethanol as it's going into machine and damage the components inside. ● Do not spray any liquid directly on the machine. Do not allow any moisture to get into the machine. 		

7. Maintenance

When the device is not in use, the power switch should be turned off and the power plug should be unplugged. When not in use for a long time, it should be powered and watered once a month for about 5 minutes each time.

8. Troubleshooting

When trouble is found, check the following points before contacting your distributor. If none of these are applicable or the trouble is not remedied even after action has been taken, the product may have failed. Contact your distributor.

Malfunction	Causes	Methods
The LED digital tube and the corresponding button indicator on the rear panel are not lit after power on.	Fuse is broken	Replace T0.5AL 250V fuse in power adapter. Replace T1.6AL 250V fuse in main unit.
	Poor contact of power plug	Plug in the power plug properly
After the power is turned on and the foot pedal is pressed, the tip does not vibrate and there is no water spray	Poor foot pedal contact	Plug in the foot pedal properly
After the power is turned on and the foot pedal is pressed, the tip does not vibrate but there is water spray	The tip is loose	Tighten the tip properly
	Tail wire failure	Contact your local distributor or our company
	Handpiece failure	Contact your local distributor or our company
	The connecting plug of the tail wire and the circuit board is loose	Contact your local distributor or our company
After the power is turned on and the foot pedal is pressed, the tip vibrates but there is no water spray	The water control knob on the handpiece is not on	Turn on the water control knob on the handpiece
	There are impurities in the solenoid valve	Contact your local distributor or our company
	Blocked waterway	Drain the waterway with dental gun
There is still water spray after releasing the foot pedal	There are impurities in the solenoid valve	Contact your local distributor or our company
Handpiece heat	Water control knob is switched too small	Turn up the water control knob
The water spray is too small	Water control knob is switched too small	Turn up the water control knob
	Water pressure is not	Increase water pressure

	enough	
	Blocked waterway	Drain the waterway with dental gun
The tip vibration is weakened	Working tip is loose	Tighten the tip
	Working tip is broken	Replace the tip
Control panel malfunction	Control panel circuit board damaged	Contact your local distributor or our company
Water seepage at the connection between the handpiece and the handpiece cord	Damaged waterproof O-ring	Replace waterproof O-ring
The root canal file does not vibrate or the file holder makes noise	Nut is not tightened	Tighten the nut
	Root canal adapter damaged	Replace the file holder
LED light is not on	LED light is damaged	Replace the LED light
	Poor contact	Check the circuit

9. Technical Data

Manufacturer	Changzhou Sifary Medcial Technology Co.
Model	UltraMint
Box dimensions	395mm×230mm×90mm
Total weight	2.8kg
Power supply	~220-240V 50/60Hz
Main unit input	~25V 50/60Hz 1.3A
Output primary tip vibration excursion	1μm-200μm
Output tip vibration frequency	25kHz~42kHz
Output half-excursion force	0.1N~2N
Output power	3W~20W
Power adapter fuse	T0.5AL250V
Main unit fuse	T1.6AL250V
Water pressure at inlet	0.1bar~5bar (0.01MPa~0.5MPa)
Electrical safety class	Class II
Applied part	B
Ingress protecting rating	Ordinary equipment (IPX0), Foot pedal (IPX1)
AP / APG type equipment	None
Anti-defibrillation application part	None
Operating mode	Continuous operation
Operating conditions	Use: in enclosed spaces Ambient temperature: 5°C ~ 40 °C Relative humidity: <80% Altitude max. 3000m
Transport and storage conditions	Ambient temperature: -20 °C ~ +55 °C Relative humidity: 20% ~ 80 % Atmospheric pressure: 70kPa ~ 106kPa

10. EMC Tables

Guidance and manufacturer's declaration – electromagnetic emissions		
The UltraMint is intended for use in the electromagnetic environment specified below. The customer or the user of the UltraMint should assure that it is used in such an environment.		
Emissions test	Compliance	Electromagnetic environment - guidance
RF emissions CISPR 11	Group 1	The UltraMint uses RF energy only for its internal function. Therefore, its RF emissions are very low and are not likely to cause any interference in nearby electronic equipment. The UltraMint is suitable for use in all establishments, including domestic establishments and those directly connected to the public low-voltage power supply network that supplies buildings used for domestic purposes.
RF emissions CISPR 11	Class B	
Harmonic emissions IEC61000-3-2	Class A	
Voltage fluctuations/flicker emissions IEC 61000-3-3	Complies	

Guidance and manufacturer's declaration – electromagnetic immunity			
The UltraMint is intended for use in the electromagnetic environment specified below. The customer or the user of the UltraMint should assure that it is used in such an environment.			
Immunity test	IEC 60601 test level	Compliance level	Electromagnetic environment - guidance
Electrostatic discharge (ESD) IEC 61000-4-2	+/- 8 kV contact +/- 2 kV, +/- 4 kV, +/- 8 kV, +/- 15 kV air	+/- 8 kV contact +/- 2 kV, +/- 4 kV, +/- 8 kV, +/- 15 kV air	Floors should be wood, concrete or ceramic tile. If floors are covered with synthetic material, the relative humidity should be at least 30 %.

Electrical fast transients/bursts IEC 61000-4-4	±2kV 100kHz repetition frequency	±2kV 100kHz repetition frequency	Mains power quality should be that of a typical commercial or hospital environment.
Surge IEC 61000-4-5	Line to line: ±0.5kV, ±1kV Line to earth: ±0.5kV, ±1kV, ±2kV	Line to line: ±0.5kV, ±1kV Line to earth: ±0.5kV, ±1kV, ±2kV	Mains power quality should be that of a typical commercial or hospital environment.
Voltage dips IEC 61000-4-11	0% UT; 0.5 cycle at 0°, 45°, 90°, 135°, 180°, 225°, 270°, and 315° 0% UT; 1 cycle and 70% UT; 25/30 cycles sine phase at 0°	0% UT; 0.5 cycle at 0°, 45°, 90°, 135°, 180°, 225°, 270°, and 315° 0% UT; 1 cycle and 70% UT; 25/30 cycles sine phase at 0°	Mains power quality should be that of a typical commercial or hospital environment. If the user of devices require continued operation during power mains interruptions, it is recommended that devices be powered from an uninterruptible power supply or a battery
Voltage interruptions IEC 61000-4-11	0% UT; 250/300 cycle	0% UT; 250/300 cycle	
Rated Power frequency magnetic field IEC 61000-4-8	30 A/m 50Hz or 60Hz	30 A/m 50Hz or 60Hz	Power frequency magnetic field should be at levels characteristic of a typical location in a typical commercial or hospital environment.
Note: UT: rated voltage(s); E.g. 25/30 cycles means 25 cycles at 50Hz or 30 cycles at 60Hz			

Guidance and manufacturer's declaration – electromagnetic immunity

The **UltraMint** is intended for use in the electromagnetic environment specified below. The customer or the user of the **UltraMint** should assure that it is used in such an environment.

Immunity test	IEC 60601 test level	Compliance level	Electromagnetic environment - guidance
---------------	----------------------	------------------	--

Conducted dis-turbances induced by RF fields IEC 61000-4-6	3 V 0.15 MHz – 80 MHz, 6 V in ISM bands be-tween 0.15 MHz and 80 MHz, 80 % AM at 1 kHz	3 V	Portable and mobile RF communications equipment should be used no closer to any part of the UltraMint , including cables, than the recommended separation distance calculated from the equation applicable to the frequency of the transmitter. Recommended minimum separation distances See the RF wireless communication equipment table in "Recommended minimum separation distances"
Radiated RF EM fields IEC 61000-4-3	3 V/m, 80 MHz – 2,7 GHz, 80 % AM at 1 kHz	3V/m	
Proximity fields from RF wireless communication equipment IEC 61000-4-3	See the RF wireless communication equipment table in "Recommended minimum separation distances"	Complies	

Recommended minimum separation distances						
<p>Nowadays, many RF wireless equipments have being used in various healthcare locations where medical equipment and/or systems are used. When they are used in close proximity to medical equipment and/or systems, the medical equipment and/or systems' basic safety and essential performance may be affected. The UltraMint has been tested with the immunity test level in the below table and meet the related requirements of IEC 60601-1-2:2014. The customer and/or user should help keep a minimum distance between RF wireless communications equipments and the UltraMint as recommended below.</p>						
Test frequency (MHz)	Band (MHz)	Service	Modulation	Maximum power (W)	Distance (m)	Immunity test level (V/m)
385	380-390	TETRA 400	Pulse modulation 18Hz	1.8	0.3	27
450	430-470	GMRS 460	FM	2	0.3	28

		FRS 460	± 5 kHz deviation 1 kHz sine			
710	704-787	LTE Band 13, 17	Pulse modulation 217Hz	0.2	0.3	9
745						
780						
810	800-960	GSM 800/900, TETRA 800, iDEN 820, CDMA 850, LTE Band 5	Pulse modulation 18Hz	2	0.3	28
870						
930						
1720	1700-1990	GSM 1800; CDMA 1900; GSM 1900; DECT; LTE Band 1, 3, 4, 25; UMTS	Pulse modulation 217Hz	2	0.3	28
1845						
1970						
2450	2400-2570	Bluetooth, WLAN, 802.11 b/g/n, RFID 2450, LTE Band 7	Pulse modulation 217Hz	2	0.3	28
5240	5100-5800	WLAN 802.11 a/n	Pulse modulation 217Hz	0.2	0.3	9
5500						
5785						

**WARNING**

1. Use of accessories and cables other than those specified or provided by the manufacturer of **UltraMint** could result in increased electromagnetic emissions or decreased electromagnetic immunity of **UltraMint** and result in improper operation.

Cable information:

Cable Name	Cable Length (m)	Shielded or not	Remark
Power adapter input cable	1.4	NO	/
Power adapter output cable	1.4	NO	/
Pedal cable	2.5	NO	/
Handpiece cord	2.0	NO	/

2. Use of **UltraMint** adjacent to or stacked with other equipment should be avoided because it could result in improper operation. If such use is necessary, **UltraMint** and the other equipment should be observed to verify that they are operating normally

11. Statement

Service Life

The service life of **UltraMint** series products is 5 years.

Maintenance

MANUFACTURE will provide circuit diagrams, component part lists, descriptions, calibration instructions to assist to SERVICE PERSONNEL in parts repair.

Disposal

The package should be recycled. Metal parts of the device are disposed as scrap metal. Synthetic materials, electrical components, and printed circuit boards are disposed as electrical scrap. Please deal with them according to the local environmental protection laws and regulation.

Rights

All rights of modifying the product are reserved to the manufacturer without further notice. The pictures are only for reference. The final interpretation rights belong to CHANGZHOU SIFARY MEDICAL TECHNOLOGY CO., LTD. The industrial design, inner structure, etc, have claimed for several patents by SIFARY, any copy or fake product must take legal responsibilities.



Changzhou Sifary Medcial Technology Co., Ltd

Add: No.99, Qingyang Road, Xuejia County, Xinbei District, Changzhou City,
213000 Jiangsu, China

Tel: +86-0519-85962691

Fax: +86-0519-85962691

Email: ivy@sifary.com

Web: www.eighteeth.com

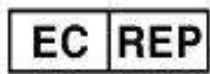

Llins Service & Consulting GmbH

Tel: +49 175 4870819

Add: Obere Seegasse 34/2, 69124, Heidelberg, Germany

Email: Llins.Service@gmail.com

Version: S01

IFU-6635004

Issued: 2020.7.1

All rights reserved.