

COXO[®]

Professional Dental Manufacturer

Since 2003

Good Price

Better Quality

Suitable Delivery

Perfect Service

Foshan COXO Medical Instrument Co., Ltd.

Add: No. 17, Guangming Ave., New Light Source Industrial Base,
Nanhai National High-tech Zone, Foshan 528226, Guangdong, P.R. China

Tel: +86 757 66692050 Fax: +86 757 81800058

Web:www.coxotec.com

Email:coxotec@gmail.com



<https://stomshop.pro/>

COXO
2024-1

2024-1

COXO[®]

Professional Dental Manufacturer

Since 2003



Catalogue 2024-1

COXO PROFILE

Foshan COXO Medical Instrument Co., Ltd. was established in 2003. It is a national high-tech enterprise focusing on the research, development, production and sales of dental medical devices. The main products are: Operating Microscope, Endo Motors, Dental Implantation Systems, Ultrasonic Surgery System, Root Apex Locators, Endodontic Obturation Systems, Dental Electrical Motors, LED Curing Lights, Dental High and Low Speed Handpiece, Teeth Whitening Accelerator, Dental Operating Light, etc.

COXO has an experienced core R&D team, lots of advanced testing, inspection and production equipment, and many national patents. COXO has passed ISO9001 and ISO13485 certifications, and its series of products have passed multiple quality certifications in China and abroad. COXO products rank among the top in the domestic market and have been exported to more than 120 countries and regions around the world, and are widely praised by users in China and abroad.

COXO invested heavily to build the "World Dental Device Museum", which collects thousands of dental equipment and instruments from dozens of countries and regions around the world in various periods, bringing together the crystallization of the history of the dental industry in China and the world into a museum, allowing The craftsmanship spirit of dental practitioners of past generations can be passed down and carried forward.

COXO adheres to the business philosophy of "pragmatic innovation, stable operation", continues to delve into the dental medical device industry, continuously expands product and service investment, and provides customers with better products and more considerate services.

CNC Center



Workshop



Laboratory



World Dental Device Museum

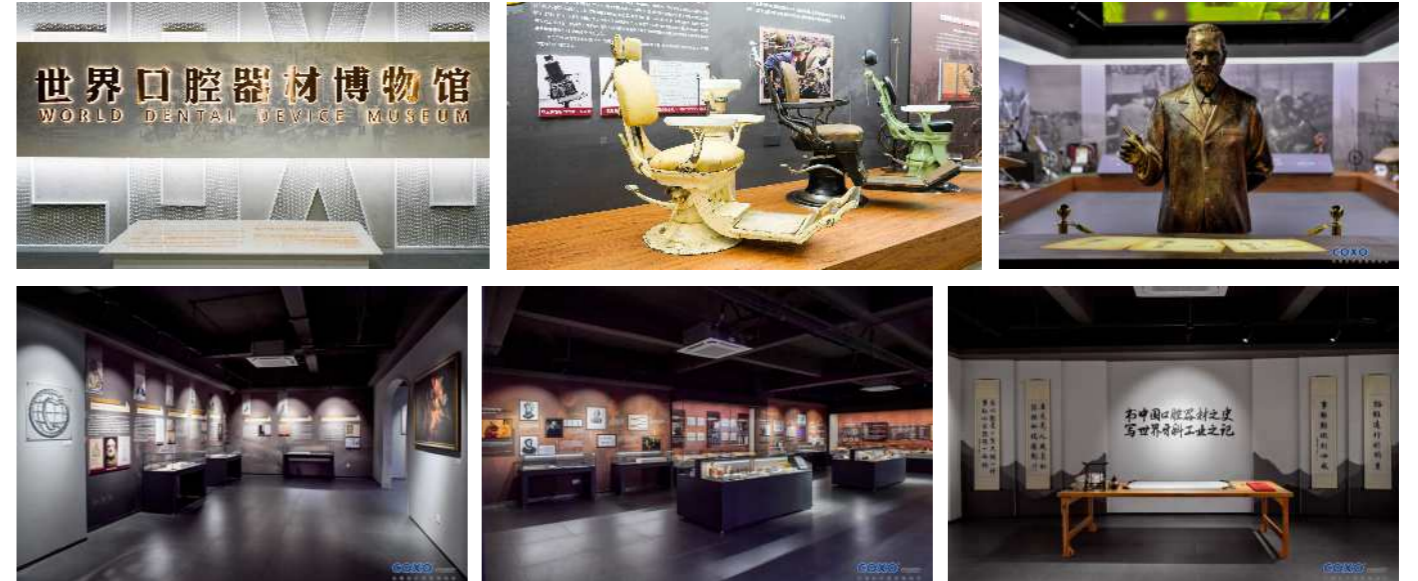

Content

| | |
|---|---------|
| Ultrasonic Surgery System | 01-02 |
| Dental Implantation Systems | 03-08 |
| Implant UA Activator | 09-10 |
| Dental Abutment Placer | 11-12 |
| Dental Implant Torque Wrench | 13 |
| Endo Motors | 15-26 |
| Endo Irrigator | 27-32 |
| Endodontic Obturation Systems | 33-36 |
| Root Apex Locator | 37-39 |
| Pulp tester, Caries detector devices | 40 |
| Niti file system | 41-46 |
| File Removal System | 47-50 |
| Gutta cuts | 51 |
| Interproximal enamel kit | 52 |
| Operating Microscope | 53-56 |
| Dental Electrical Motors | 57-62 |
| LED Curing Lights | 63-73 |
| Teeth whitening accelerator | 74 |
| Dental alginate mixers, amalgamators | 75-76 |
| Dental Scaler and Air Polisher | 77-78 |
| Dental Polisher | 79-82 |
| Prophylaxis Powder | 83-84 |
| Air Abrasion System with spray | 85-86 |
| Dental Anesthesia Booster | 87-88 |
| Accessory of electric equipment | 89-92 |
| 4 way spray handpiece | 94-96 |
| Led handpiece with generator | 97-100 |
| Optical handpiece | 101-102 |
| 1way spray handpiece | 103-106 |
| 3way spray handpiece | 107-108 |
| Color handpiece | 109-110 |
| Nature handpiece | 111-112 |
| Optical handpiece | 113 |
| 1 way spray handpiece | 114 |
| Nature handpiece | 115-116 |
| Speed increased contra angle | 117-122 |
| Reduction contra angle | 123-124 |
| Low speed handpiece set | 125-128 |
| Contra angle handpiece, air motors, stright handpiece | 129-132 |
| Economical complete kit | 133 |
| Handpiece accessories | 134-138 |
| OEM,ODM Service | 139 |
| Dental operating light | 141-144 |

New New technology



C-EXPLORER Ultrasonic Surgery Systems

Powerful
Stable
Multipurpose

01 Ultrasonic Surgery Systems



Ultrasonic Surgery Systems

Model: C-Explorer

Order code: C-EXPLORER

Technical:

| | |
|------------------------------------|-------------------------|
| Power-supply voltage: | 100-240V 50/60Hz 150VA |
| Device for intermittent operation: | 60s ON, 10s OFF |
| Fuses: | 3.15AT 250V |
| Flow: | 45-100ml/min |
| Radial amplitude: | 8-63um |
| Tranverse amplitude: | 1.5-12um |
| Working tips frequency: | 23.8kHz-32.2kHz |
| Handle: | 130.3*Φ33.5mm |
| Volume(cm): | 28×23×14cm |
| Weight(kg): | 3.4kg |
| Tips (basic kit): | US1/US2/US4/US5/UL3/UC1 |

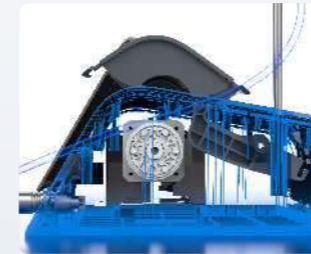

Silent water pump
comfortable operating experience



Multi-function foot pedal
control of multiple functions



Tips kit
US1/US2/US4/US5/UL3/UC1

02 Ultrasonic Surgery Systems

LED lighting



Separation design

Multi-mode operation switch freely



Bone mode



Perio mode



Endo mode



Cleaning mode

- a) Power 6-7: Very high bone density
- b) Power 4-5: High bone density
- c) Power 2-3: Middle bone density
- d) Power 1: Low bone density

C-SAILOR PRO+ Dental Implantation System
 Implant mode & Surgery mode
 Graphical interface, Multiple program options

2 in 1

Order code: C-SAILOR PRO+

Technical:

| | |
|----------------------------|------------------------|
| Maximum power: | 120VA |
| Power supply: | AC 110V 60Hz/230V 50Hz |
| Motor speed: | 300r/min~4000r/min |
| Maxima torque(20:1): | 70N.cm |
| Water supply volume: | 5 level adjustable |
| Light source illumination: | 30000lux |
| Input Voltage: | d.c.30V |
| Volume(cm): | 28x25x12 |
| Weight(kg): | 3.4 |



Implant mode & Surgery mode 2 in 1

Powerful and user-friendly



Implant mode

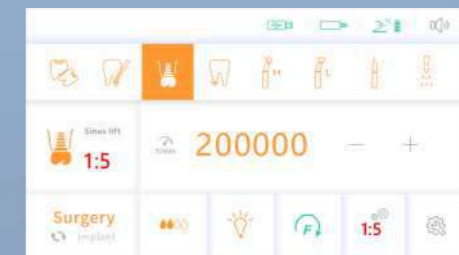

Surgery mode



Software updates
Torque store



Metal connector
More stable, longer life

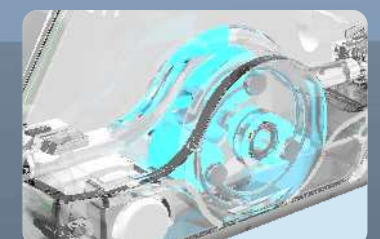

Silent, waterproof
peristaltic pump

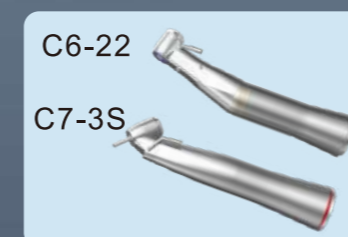

Standard 2pcs
contra angle



LCD color large
screen

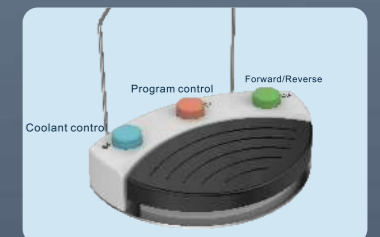

Wireless pedal

Model: C-Sailor

C-SAILOR PRO Dental Implantation System

Intuitive
Powerful
Safe & Reliable

Order code: C-SAILOR PRO

Technical:

| | |
|----------------------------|-------------------------------------|
| Maximum power: | 130VA |
| Power supply: | AC110V 60Hz / 230V 50Hz |
| Motor speed: | 300-40000rpm |
| Adjustable torque: | 5Ncm- 80Ncm (20:1) |
| Water supply volume: | 4 level adjustable, up to 150ml/min |
| Light source illumination: | 30000lux |
| Motor: | surgical brushless motor |
| Volume(cm): | 42x38x26cm |
| Weight(kg)/PCS | 5.5kg |
| Packing material | Aluminum box |
| QTY per master carton | 2 pc/ctn |



05
Dental Implantation
Systems

06
Dental Implantation
Systems

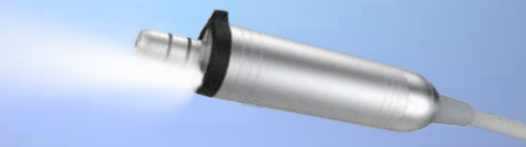

Fiber optic contra angle
High brightness LED light
source up to 30000lux



-Full touch 7 inch screen-
Large size screen ensures that
the treatment parameters are
visible at any time



Built-in water supply system
4 shifts water supply
up to 150ml/min

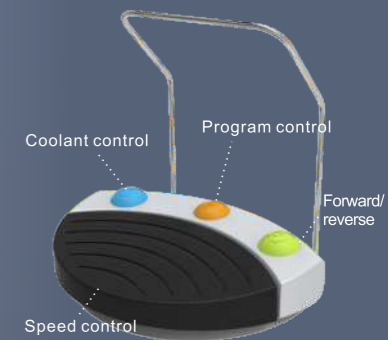

Full function pedal controller
Aseptic operation can be achieved
giving the maximum freedom of the handle

Patent design, delicate contracted

This product has been applied layout-design patent,
Counterfeit must be investigated.



The large size screen ensures that the treatment parameters
are visible at any time



Order code: C-SAILOR

C-SAILOR Dental Implantation System

Efficient
Big screen
Stable & Safe



The first Chinese brand implant machine which get license from Chinese government for producing and selling

Technical:

| | |
|--------------------------|--------------------------|
| Maximum output power | 120VA |
| Power | AC110V 60Hz / 230V 50Hz |
| Adjustable torque, range | 5.0-55N.cm(20:1) |
| BLDC Speed | 300rpm-50000rpm |
| Infusion flow(maximum) | 150ml/min |
| Motor | Surgical brushless motor |
| Volume(cm) | 40X33X26.5 |
| Weight(kg)/PCS | 8.2 |
| Packing material | Aluminum box |
| QTY per master carton | 2 pc/ctn |



choose
Built-in 10 setting program

High performance control system
10 kinds of the reduction contra angle to



Big Screen

Clear and easy to understand



- Coolant control
- Program control
- Forward/Reverse



Multi functional foot pedal

Could achieve all the operation function
Easy and flexible



Built-in water supply system

5 shifts water supply
up to 150ml/min

07 Dental Implantation Systems

08 Dental Implantation Systems

This product has been applied layout-design patent,
Counterfeit must be investigated:NO.ZL201230103509.0

UA-1 Implant UA Activator

10s Activation

Ultra strong implant compatibility

10 Implant UA Activator



Model:UA-1

Implant UA Activator

Order code: UA-1

Technical:

| | |
|--------------------|-------------------|
| Adapter: | AC100-240V50/60Hz |
| Input power: | 220W |
| Ozone production: | <0.02ppm |
| Activation time: | 10s |
| UV wavelength : | 172nm |
| Weight: | 5.5kg |
| Control unit size: | 18.7×31.6×33.1cm |



Activation takes only 10s



Air gesture
Zero contact is safer



10 Implant UA Activator

High compatibility of implants



Voice-recognition & LED prompt



In standby mode

Activating

Activation Complete

CI-1 Dental Abutment Placer



Straight adapter & curved adapter



impact head
Medical engineering plastic impact head, capable of high-temperature sterilization

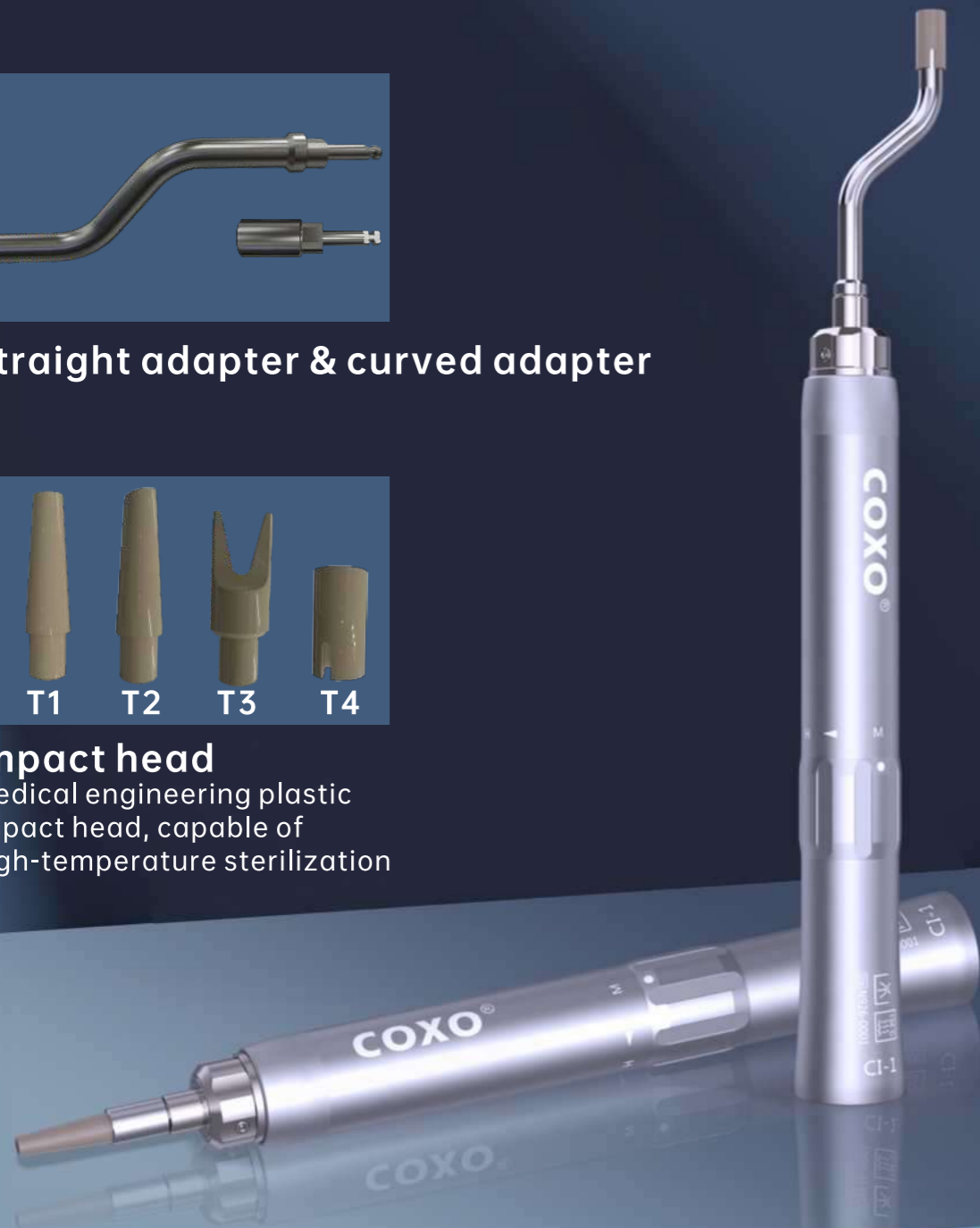

Model:CI-1

Dental Abutment Placer

Technical

- Length: 145mm
- Shell length * diameter: 128mm*20mm
- Weight: 120g
- Recommended air pressure for pneumatic motors: 0.02~0.1Mpa
- Paired with motor output torque: 0.75N.cm
- Matching motor speed: 12000rpm



Order code:CI-1



Model: C-TW1

Dental Implant Torque Wrench



Order code: C-TW1 Kit

Feature:

1. 10/15/20/25/30/35N torque gears
2. 16 kinds of screwdrivers
3. Used and upgraded the COXO implanting contra angle

Technical:

Torque: 10-35N.cm

Screwdriver type: ϕ 2.35

Volume(cm) 13.8x13.8x15

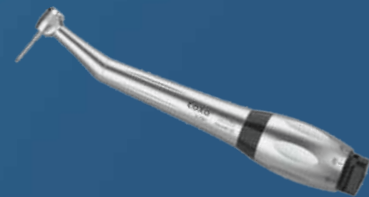

Order code: C-TW1

The conventional design of COXO implanting contra angle has been used with better quality and longer service life



Order code: C-SK1

16 kinds of screwdrivers of different specifications fully compatible with more than 30 mainstream implant systems

13
Dental Implant
Torque Wrench

Model: C-TW2

Dental Implant Torque Wrench



Order code: C-TW2 Kit

Feature:

1. Equipped with 16 different screwdrivers,
2. More optimized structural design, more in line with ergonomics and the actual needs of clinicians.
3. CNC precision machining to ensure accurate torque.
4. Aluminum alloy box, can be sterilized at high temperature and high pressure
5. Paired with silicone pins of different colors

Technical:

Torque: 15-70N.cm

Screwdriver type: ϕ 7.5

Volume(cm) 15.7x12.5x5



Order code: C-TW2

More optimized structural design, more in line with ergonomics and the actual needs of clinicians



Order code: C-SK2

16 kinds of screwdrivers of different specifications, fully compatible with more than 30 mainstream implant systems

Endo Series



C-SMART-I PILOT Endo motor

Large screen, but also wireless
Simple, but also rich functional
Split Endo motor & Apex locator

Order code: C-SMART-I PILOT

Technical:

- Adaptor working voltage: Input: AC100~240V, 50Hz
Output: DC10V, 1.5A
- Rotation speed range: 150~1000rpm
- Torque: 0.6~3.9N.cm
- File system: 6 mainstream brands
30 endo file systems
200+ file parameters
- Volume: 24x24x7.5cm
- Weight: 1.5kg
- Packing material: carton
- QTY per master carton: 10 pc/carton



15 Endo Motors



Powerful Bluetooth
Stronger connection
10m effective distance

Smart Pilot Function

Glide path

It reproduces the subtle and delicate finger movements of an experienced dentist



Canal shaping

Greatly reduce the chance of jamming or file breakage
Treated faster and more safely



16 Endo Motors

Innovative Contra angle

- Built-in LED light
- Built-in root canal measurement connection
- Detachable Integrated Insulation Contra Angle
- Can rotate freely at 300°
- Can be sterilized by 135°C high temperature and high pressure

This product has been applied layout-design patent, Counterfeit must be investigated.

C-SMART-I PRO Endo motor

Touch control, System inside
With LED light
With Apex locator function

Order code: C-SMART-I PRO

Technical:

| | |
|--|-----------------------|
| Adaptor working voltage | AC100-240V,50/60HZ; |
| Adjustable torque,range | 0.6-5.2N.cm(6-52mN.m) |
| 5 setting for adjustable rotational speed ranging: | 150rpm-650rpm |
| Volume(cm) | 23.5X20X14.5 |
| Weight(kg)/PCS | 2.8 |
| Packing material | carton |
| QTY per master carton | 6 pc/ctn |



17 Endo Motors



Built-in mainstream system



18 Endo Motors

Endo motor & Apex locator Dual mode

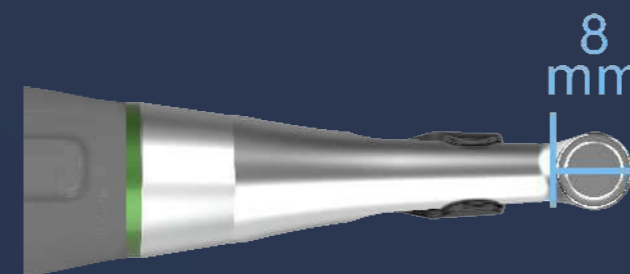

16:1 mini head contra angle

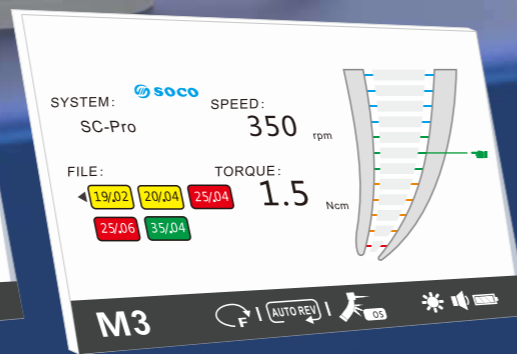
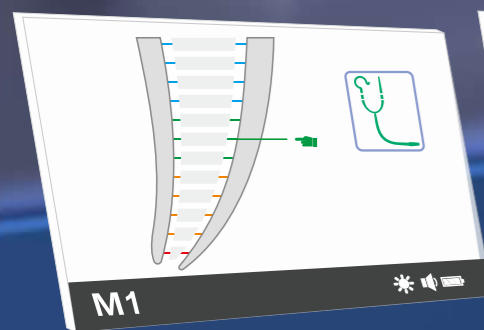
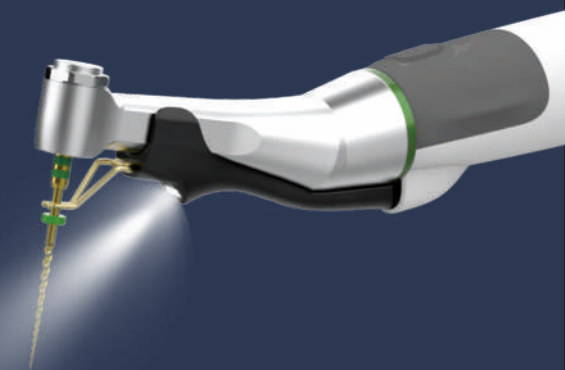

Big color LCD screen



C-SMART MINI2 NOVA Endo motor
Smaller-Safer



Model: C-SMART-NOVA

Endo Motors

Order code: C-SMART-MINI2 NOVA

Technical:

| | |
|-------------------------|---------------------|
| Adaptor working voltage | AC100-240V 50/60HZ; |
| Adjustable torque,range | 0.6-3.9N.cm |
| Rotation speed range: | 100-1000rpm |
| Volume(mm) | 130.2×23.4×20.5 |
| Weight(kg)/PCS | 2.8 |
| Packing material | carton |
| QTY per master carton | 6 pc/ctn |

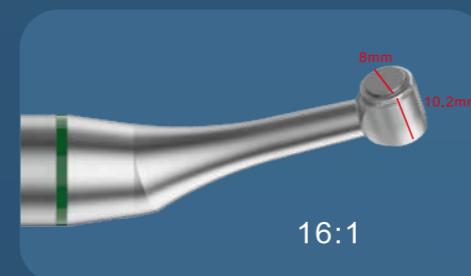

Super-mini contra angle

Easily reach every treatment area
Contra angle speed ratio 16:1



5 Programs

P1~P3 : Memory program
P4 : Reciprocation program
P5 : OGP program

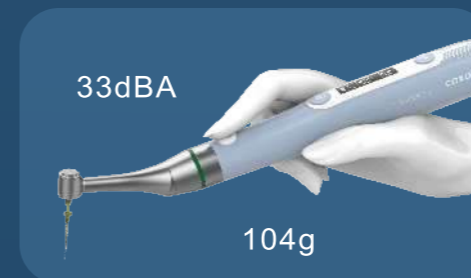

Lighter and Quieter

Reducing hand fatigue , give you the best feel
Improved motor , lower noise , allows you to better focus on treatment



The maximum speed can reach to 1000 rpm



OGP Mode

Special ledge bypassing function
safer and more convenient

New technology

C-SMART MINI Brushless Endo motor AP+

Wireless Endo Motor & Apex Locator
Powerful Functions
Precise Measurements
Efficient And Safe



100 rpm Min speed  2500 rpm Max speed

21 Endo Motors

Model: C-SMART-MINIAP+

Endo Motors

Order code: C-SMERT-MINI AP+



Technical:

| | |
|-------------------------|---------------------|
| Adaptor working voltage | AC100-240V 50/60HZ; |
| Adjustable torque,range | 0.6-5.0 N.cm |
| Rotation speed range: | 100-2500rpm |
| Volume(cm) | 19X13X6 |
| Weight(kg)/PCS | 0.7 |
| Packing material | carton |
| QTY per master carton | 12 pc/ctn |

22 Endo Motors



5 working mode



6:1 contra-angle



Smart wake up function



convenient wireless charge

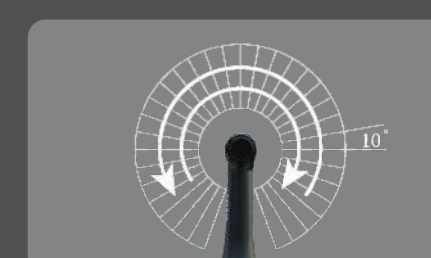

Adjustable reciprocating angle (10° for each unit)

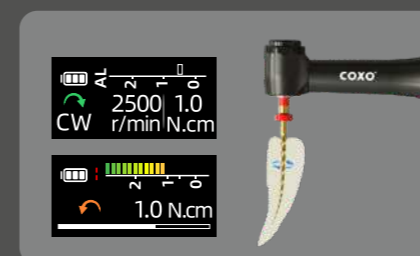

Apex locator & endodontic treatment

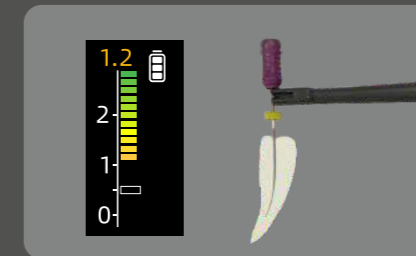

Apex locator



Color screen display

C-SMART MINI AP Endo motor
 Wireless endo motor & apex locator
 Powerful functions
 Precise measurements
 Efficient and safe

Order code: C-SMART-MINI AP

Technical:

| | |
|--|-----------------------|
| Adaptor working voltage | AC100-240V 50/60HZ; |
| Adjustable torque, range | 0.6-3.9N.cm(6-39mN.m) |
| 5 setting for adjustable rotational speed ranging: | 150-600rpm |
| Volume(cm) | 19X13X6 |
| Weight(kg)/PCS | 0.7 |
| Packing material | carton |
| QTY per master carton | 12 pc/ctn |



23 Endo Motors

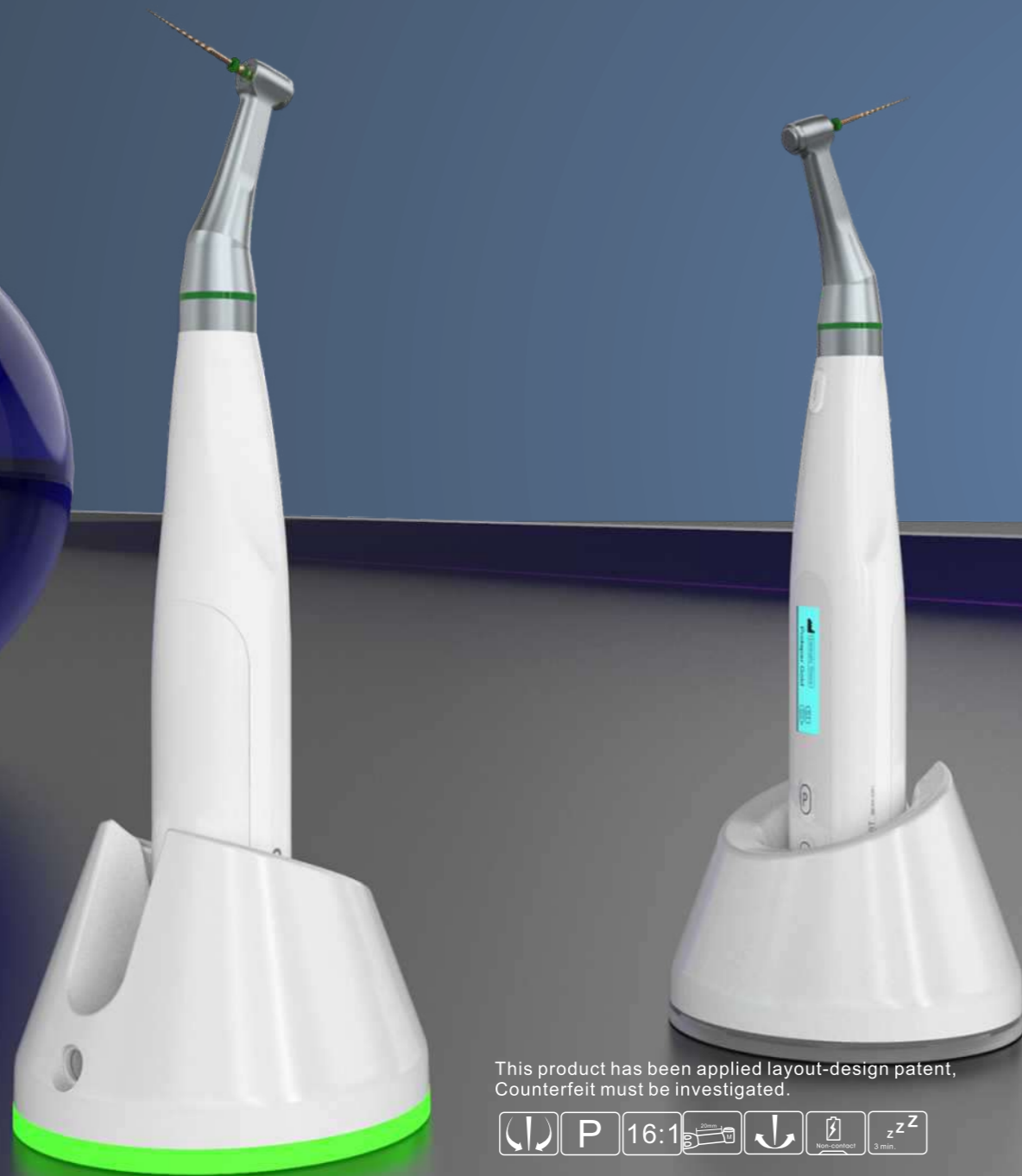

This product has been applied layout-design patent, Counterfeit must be investigated.



24 Endo Motors



With 6 mainstream brands,
31 mult file system
Almost 200 Endo files parameters



16:1 Mini Head Design
360° Rotation, Meet the needs of various treatment angles



3 working mode
Auto-switch work mode
Colorful and sound prompt

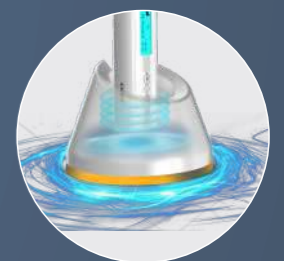

Non-contact recharge
Faster and safer

Switchable screen
Easy for right or left hand use

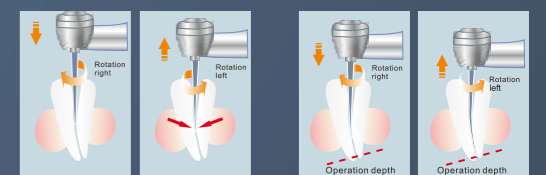
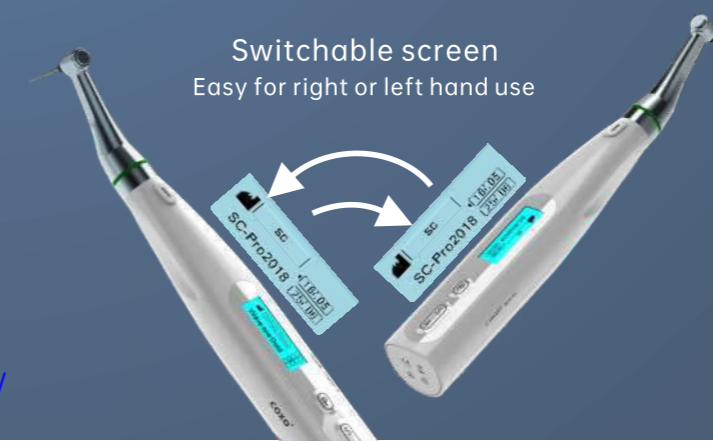

• auto reverse by torque • auto reverse by apical position

Order code: C-SMART-MINI

Technical:

| | |
|--|------------------------|
| Adaptor working voltage | 100-240Vac, 50/60HZ; |
| Adjustable torque, range | 0.6-3.9N.cm (6-39mN.m) |
| 5 setting for adjustable rotational speed ranging: | 125rpm-625rpm |
| Volume(cm) | 19X13X6 |
| Weight(kg)/PCS | 0.7 |
| Packing material | carton |
| QTY per master carton | 12 pc/ctn |

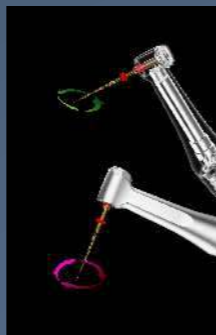

Reciprocation



Non-contact recharge design



This product has been applied layout-design patent, Counterfeit must be investigated.

Order code: C-SMART-MINI (LED)

Technical:

| | |
|--|------------------------|
| Adaptor working voltage | AC100-240V, 50/60HZ; |
| Adjustable torque, range | 0.6-3.9N.cm (6-39mN.m) |
| 5 setting for adjustable rotational speed ranging: | 125rpm-625rpm |
| Volume(cm) | 19X13X6 |
| Weight(kg)/PCS | 0.7 |
| Packing material | carton |
| QTY per master carton | 12 pc/ctn |

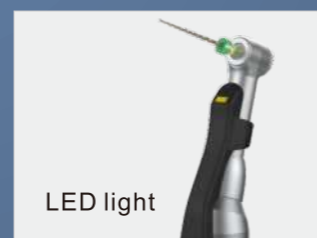

LED light

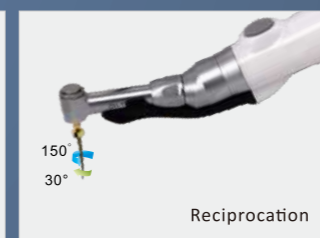

Reciprocation



LED screen

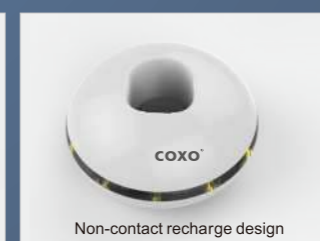

Non-contact recharge design



This product has been applied layout-design patent, Counterfeit must be investigated.

ULTRA SMART Endo Ultrasonic Activator

Safer
Cleaner
Professional

Model: Ultra Smart

Endo Ultrasonic Activator

Order code: ULTRA-SMART

Feature:

1. High frequency ultrasound up to 38kHz.
2. Variable frequency control, self adjusting frequency in treatment.
3. Activation sequences of 20 sec.
4. With LED lighting system.
-

Technical:

Volume: 17x17x6 cm

Weight: 0.65 kg

Packing material: carton

QTY per master carton: 8 pcs/carton



CU1*3



27 Endo Irrigator

28 Endo Irrigator

ULTRA SMART AI Ultrasonic Activator
Safer
Cleaner
Powerful and multi-use.

29 Endo Irrigator



Developed with Prof. Alfredo Landolo

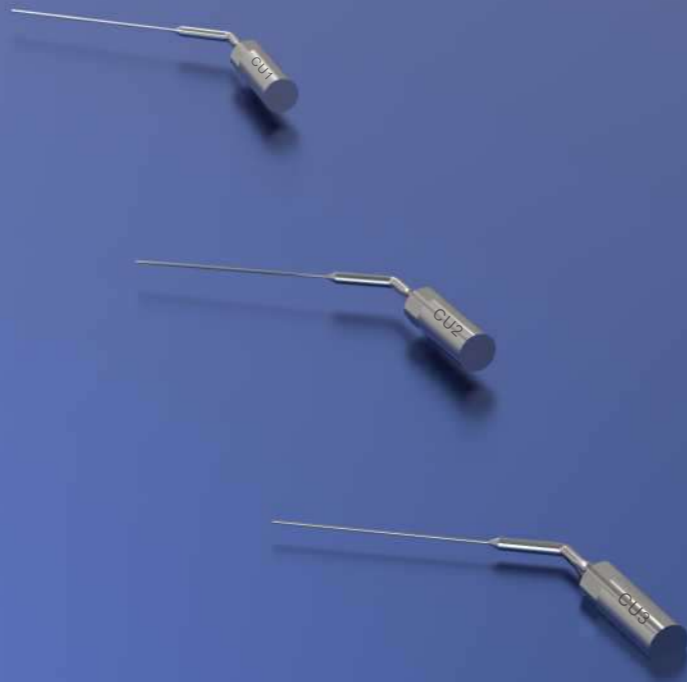

Model: Ultra Smart

Endo Ultrasonic Activator

Order code: ULTRA-SMART AI

Feature:

1. High frequency ultrasound up to 38kHz.
2. Variable frequency control, self adjusting frequency in treatment.
3. Activation sequences of 20 sec.
4. With LED lighting system.

Technical:

Volume: 17x17x6 cm
 Weight: 0.65 kg
 Packing material: carton
 QTY per master carton: 8 pcs/carton



3 Working mode

High power mode
 Removing broken endo file



Middle power mode
 Normal irrigation

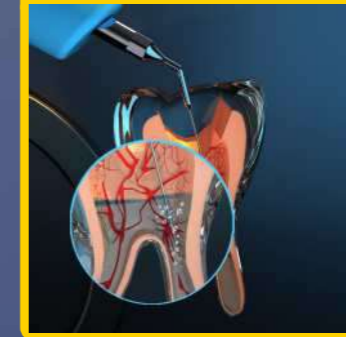

Low power mode
 Smallest tip to clean small canal

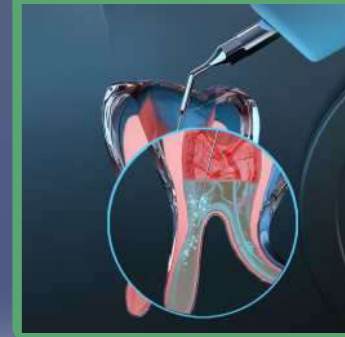

30 Endo Irrigator

Built-in LED light
 Easily observe the treatment area

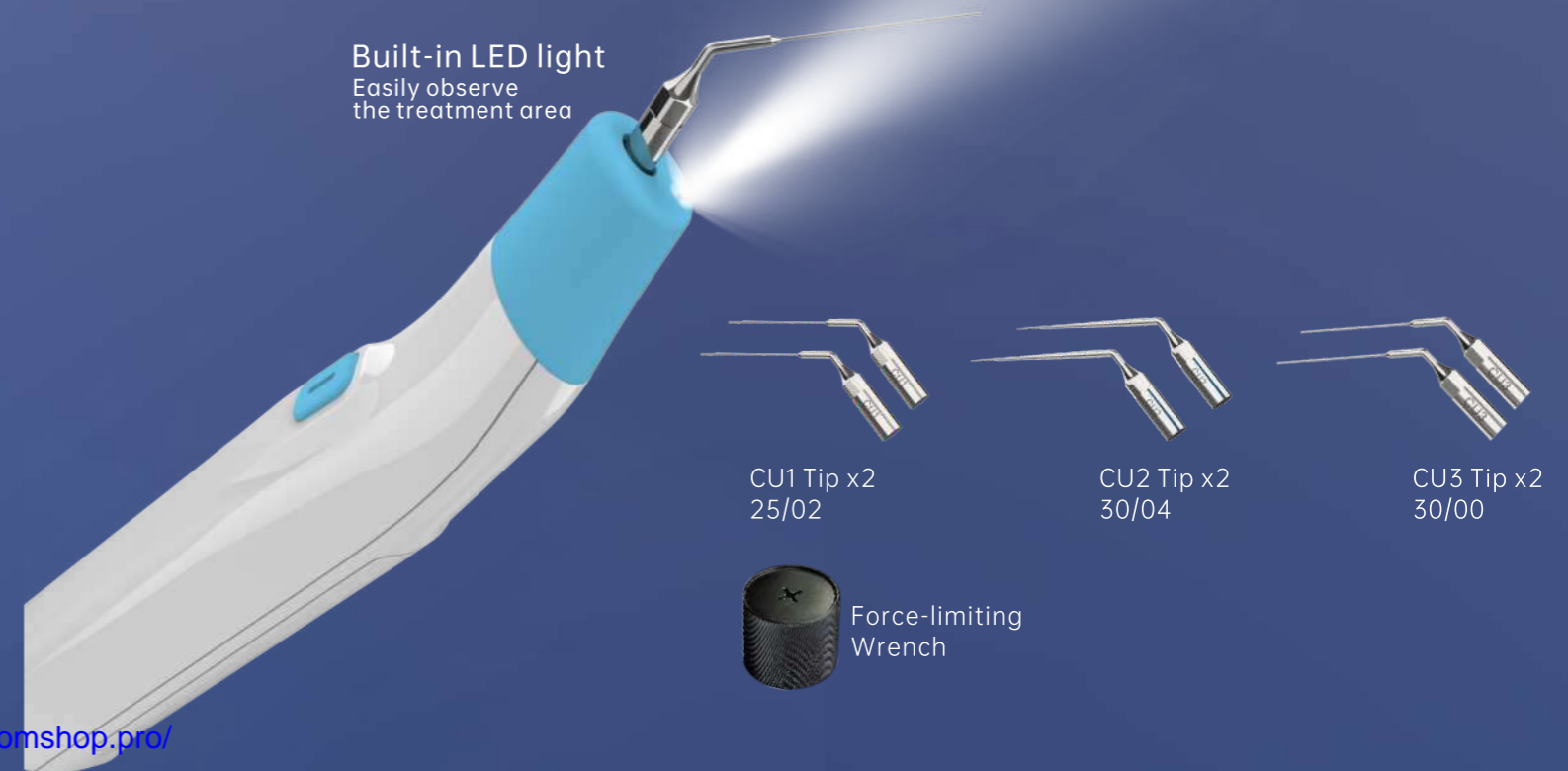

CU1 Tip x2
 25/02

CU2 Tip x2
 30/04

CU3 Tip x2
 30/00

Force-limiting Wrench

C-RCC Root Canal Irrigation And Suction System

Continuous flushing
With heating function
Negative pressure flushing



Developed with
Dr. Mandar Pimprikar



Model: C-RCC

Root Canal Irrigation and Suction System

Order code: C-RCC

Feature:

1. Three working modes: irrigate, suction and suction while irrigate
2. With heating function: can heat the irrigants to improve the disinfection effect by 400%
3. Joint developed This product is co-developed from the rich clinical experience of experts.

Technical:

Power: AC100-220V 50/60Hz

Irrigate flow: 2-5ml/min

Suction flow: Tip A: >10ml/min; Tip B: >3ml/min

Volume: 35x26x11cm

Weight: 1.65 kg

Packing material: carton



Irrigation mode only
Working time:30s

3



Suction mode only
Working time:120s

Working modes



Circular irrigation mode
Working time:30s/60s/90s/120s

Standard
2 types of tip



Tip B
Longer needle: 27G, for suction
Shorter needle: 21G, for irrigation



Tip A
Longer needle: 27G, for irrigation
Shorter needle: 27G, for suction

Multi-function mode
of irrigation and suction
allows irrigation and suction to be carried out at the
same time

With heating function

Improve the disinfection effect by 400%
making it safer and more efficient.

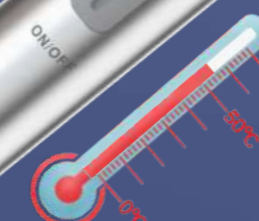



C-FILL X Endodontic Obturation system

Precise temperature control
Perfect filling



Order name: C-FILL X Set

Model: C-Fill X

Endodontic Obturation Systems

Order code: C-FILL X

Technical:

Battery: DC3.6V 2200mAH
Working temperature: 140 °C, 160 °C, 180 °C, 200 °C
Adapter: input AC 100~240V, output DC5V 4A
Use time: ≥30min
Needle specifications: 23G, 25G



Built in dental gum removal function

Simultaneously press and hold the "M" and "⏻" keys to clear the cavity dental gum

360° circular button

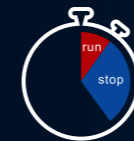

Heating protection

Discontinuous operation, work for 1 minute, stop for 3 minutes

Grasp to wake up, no need to repeatedly turn on/off the machine

Order code: C-FILL Mini P type

Technical:

Battery: DC3.7V 2000mAH
Heating time: 4S(With heat protection function, the single heating time is up to 4 S)
Working temperature: 150 °C, 180 °C, 200 °C, 230 °C
Adapter: input AC 100~240V, output DC5V 1.5A
Use time 1.5H
Plunger specifications: F 45/02, FM 50/04, M 55/06, ML 55/08

Different angle
Easy to reach any treatment places



Faster heating
P type can archive 200°C in 0.5s

Intelligent reminder
Sound and flashing prompt
With protection function, single heating time up to 4s

Precise temperature control
Good performance give you the most smooth cutting of gutta-percha



C-FILL mini P type

Endodontic Obturation Systems

Endodontic Obturation Systems

C-FILL MINI Endodontic Obturation system

Precise temperature control
Perfect filling

35 Endodontic
Obturation Systems



Order name: C-FILL Mini

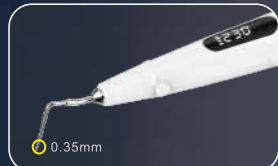

The tip of plunger with minimum diameter 0.45mm, 0.2 taper, can press the effective filling position that is 3 mm from the Apex.

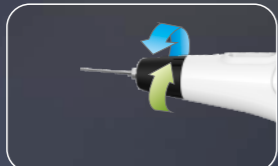

The gun head can be rotated by $\pm 100^\circ$ for easy use.



Double-sided button operation, convenient and fast



360° dynamic charging display, more humane.

Model: C-Fill

Order code: C-FILL Mini G type

Battery: DC3.7V 2200mAH

Heating time: 15 s To 200 °C.

Working temperature: 150 °C, 180 °C, 200 °C, 230 °C

Adapter: input AC 100~240V, output DC5V 1.5A

Use time 1.5H

Needle specifications: 23G, 25G



Accurate temperature control

Automatically cool down to 150°C on the base
Save electricity and prevent glue overflow

Endodontic Obturation Systems



Faster heating
G type can archive 200°C in 15s



New wrench design
Help you to push more accurately

35 Endodontic
Obturation Systems

Order code: C-FILL Mini P type

Battery: DC3.7V 2000mAH

Heating time: 4S(With heat protection function, the single heating time is up to 4 S)

Working temperature: 150 °C, 180 °C, 200 °C, 230 °C

Adapter: input AC 100~240V, output DC5V 1.5A

Use time 1.5H

Plunger specifications: F 45/02, FM 50/04, M 55/06, ML 55/08

Different angle
Easy to reach any treatment places



Faster heating
P type can archive 200°C in 0.5s

Intelligent reminder
Sound and flashing prompt
With protection function, single heating time up to 4s



Precise temperature control
Good performance give you the most smooth cutting of gutta-percha



C-FILL mini P type

| Heat plunger | | |
|--------------|------------|------------|
| Size | Color code | Taper/Size |
| #XF | Green | 0.02#35 |
| #F | White | 0.02#45 |
| #FM | Yellow | 0.04#50 |
| #M | Red | 0.06#55 |
| #ML | Red | 0.08#55 |



| Needle | | |
|--------|----------|--------|
| Gauge | Diameter | Length |
| 23ga | 0.65mm | 23mm |
| 23ga | 0.65mm | 23mm |
| 25ga | 0.55mm | 23mm |
| 25ga | 0.55mm | 23mm |



C-ROOTI+ Root apex locator

Touch precision
All touch TFT LCD

Model: C-Root I

Root Apex Locators

Order code: C-ROOT I+



Technical:

| | |
|--------------------------|---|
| Adaptor working voltage: | AC100-240V,50/60HZ; |
| Battery: | DC7.4V 1800mAh changeable Li-ion battery |
| Display: | color TFT-LCD touch screen |
| Display specifications: | size:73.44x48.96mm(3.5inch) resolution:480x320 |
| Charge time: | 3hours |
| Volume(cm): | 16X14X6.5 |
| Weight(kg)/PCS | 0.7 |
| Packing material | carton |
| QTY per master carton | 12 pc/ctn |

37
Root apex locator

Colorful touch screen
Easy to adjust various parameters

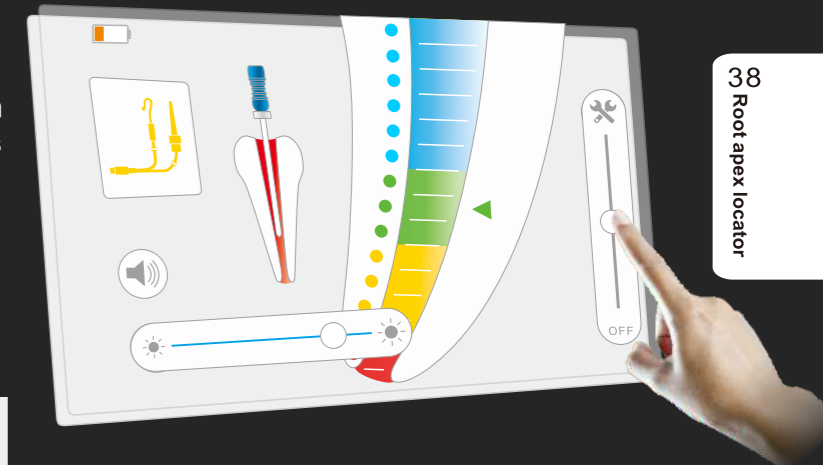

38
Root apex locator

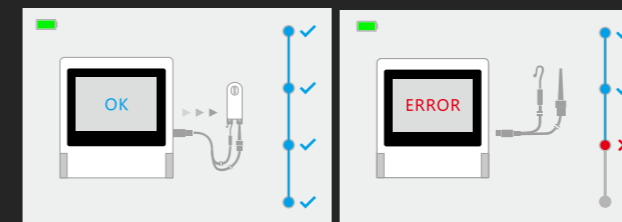

Automatic check function
Ensure you the accuracy of each measurement



Simple and light
The thickness is only 2cm, but it brings unimaginable accuracy

This product has been applied layout-design patent,
Counterfeit must be investigated;NO.ZL201530423195.6

Foshan COXO Medical Instrument Co., Ltd.

Add: No. 17, Guangming Ave., New Light Source Industrial Base,
Nanhai National High-tech Zone, Foshan 528226, Guangdong, P.R. China

Tel: +86 757 66692050 Fax: +86 757 81800058

Web:www.coxotec.com

Email:coxotec@gmail.com

Issue Date: 2023-02-10

<https://stomshop.pro/>



Feature:

- 1-Root canal apex finder and pulp vital measurement;
- 2-Color LCD screen display and can adjust the angle you need;
- 3-Multi-frequency design, exact accurate;
- 4-Accurate current-stabilized generate technology
- 5-Self-test function in apex locator;
- 6-The narrow zone of the apex can be adjust if the doctor need;
- 7-Sound prompt for the apex in the narrow zone of the pulp vital;
- 8-Rechargeable Li-ion battery and charger

Technical

- 1.Adaptor voltage : AC100-240V, 50/60HZ
- 2.Battery:7.4V/2000mAh changeable Li-ion battery
- 3.Charge time:3 hours
- 4.Display:color LCD Screen,buzzer

Volume/Weight

- 1.Volume(cm):24X19X9
- 2.Weight(KG)/PCS:2.0KG
- 3.Packing material: carton
- 4.QTY per master carton : 6 pc/ctn

Order code: C-ROOTI(VI)
Root apex locator with pulp tester

39 Root apex locator

Two working modes

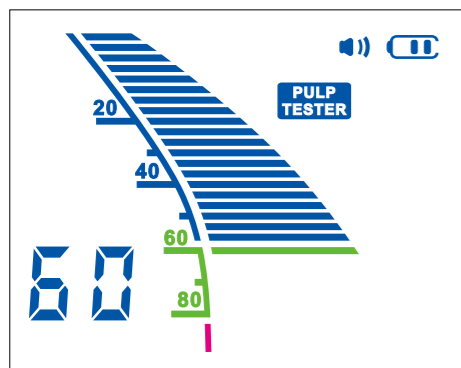

Pulp tester mode

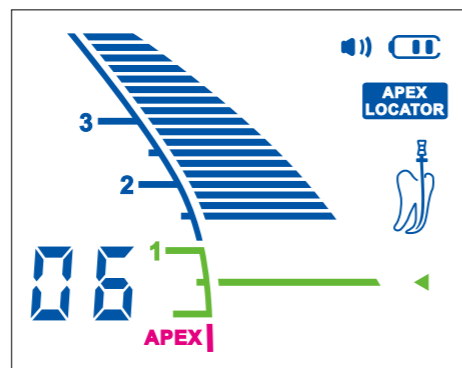

Apex locator mode

Accessories



Feature:

- 1-Preset speed mode(high-mid-low speed)
- 2-Agentle, pulsed stimulus begins to increase at a rate specifically designed for patient comfort.
- 3-If the patient indicates perception, simply release the button, the stimulus stops immediately, but the numbers remain frozen on the screen for about 3 minutes.
- 4-Specifically designed for patient comfort.
- 5-Convenient to operate.
- 6-Maximum stimulus--80.between 0-40, the patient feels ache and anesthesia, alive teeth nerve.
- 7-Between 40-80, with above-mentioned reaction, part of teeth nerve dead; 80, no above-mentioned reaction, dead teeth nerve.
- 8-The device turns itself off in three minutes after operation (No wasted batteries).

Order code: C-PULSE

This product has been applied layout-design patent, Counterfeit must be investigated; NO.ZL200730333925.9

40 Pulp testers, Detection device

Caries Detection Devices



Simple, Effective, Innovative caries detection
Competitive with the products of KaVo and W&H

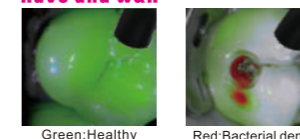

Feature:

- 1-Effective function for decayed tooth- detection , quickly, easily, painless
- 2-Wireless operation, Lightness using
- 3-Support minimally invasive surgery, safely, lighten patient's fear
- 4-Mini slender mainframe designing, provide the best treatment operation

Technical:

| | |
|--------------------------|--|
| Adaptor working voltage: | AC100-240V,50/60HZ; |
| Lightwave Data: | LED intensities:40-280mw LED wavelength:380-420nm |
| Volume(cm): | 16X14X6.5 |
| Weight(kg)/PCS | 0.5 |
| Packing material | carton |
| QTY per master carton | 6 pc/ctn |

Order code: C-HUNTER

Function:

Bacteria in dentine infected by caries leave behind metabolic products (porphyrins). when an exposed cavity is illuminated with violet light, these porphyrins show a red fluorescence, thereby indicating the significant areas for caries excavation.

C-hunter aids detection and monitoring of carious tooth substance, in particular in dentin, during the excavation of previously opened cavities.

According to the particular fluorescence properties of the degradation product which is produced by the cariogenic bacteria, substances with teeth for removing infected, to remove the infected material on the teeth.

Accessories

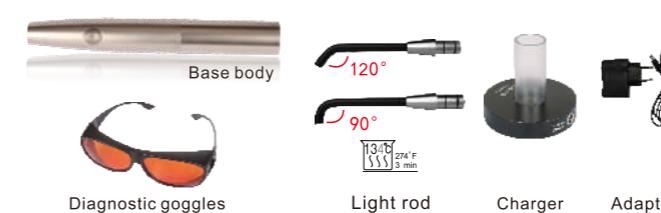

SC-PRO2018 CONTROLLED MEMORY FILES

- High elasticity
- More Safety
- More Efficiency
- More Durable

41
NITI file System

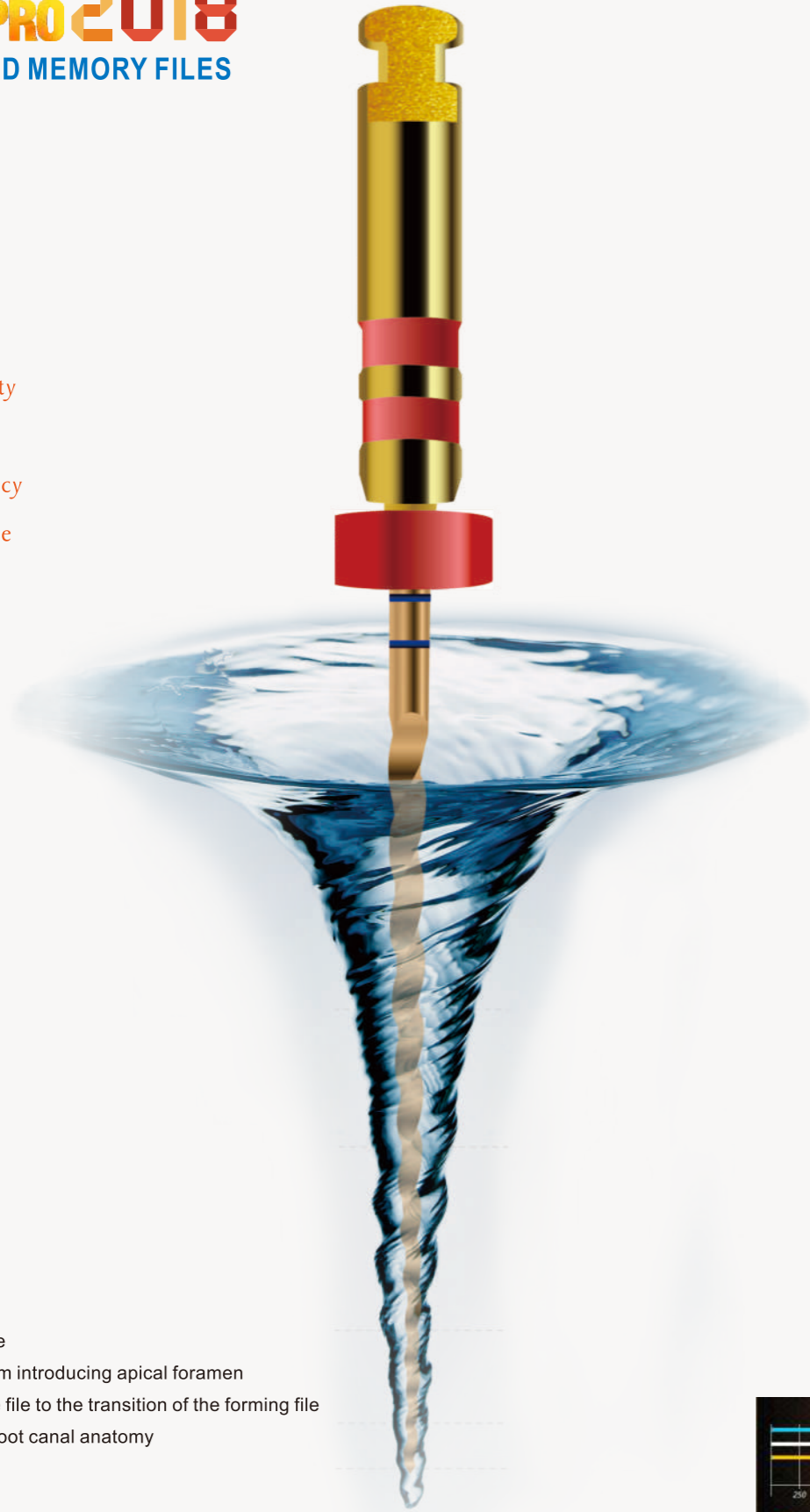

Use nickel titanium file
to prevent detritus from introducing apical foramen
Optimized to clear the file to the transition of the forming file
Protection of curved root canal anatomy

leading operation concepts, advanced technical support
to the leap of the SC-pro NITI file.

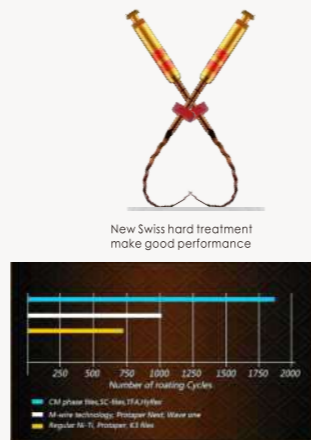

Anti-cycle Fatigue Comparison

Model: SC-PRO

Dental Root Canal Instruments

SC-PRO2018 CONTROLLED MEMORY FILES

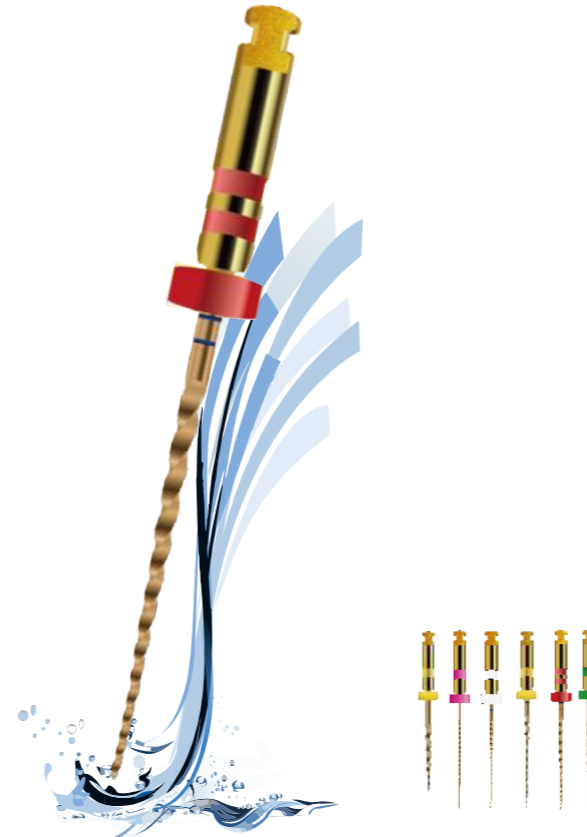

New series of SC-PRO 2018:
only need to dredge up to Hand use file K10.

Feature:

1. Upgrade open file 17/12, more reasonable.
 2. With dual-variable taper of path file, nickel titanium file can be used after 10# hand file
 3. Upgrade shaping file 18/05, more perfect for the processing.
 4. Upgrade material, more flexible.
- Among classic 6 pcs system file, only it can used nickel titanium file after 10# hand file
 - SC Pro-2018 more suitable for the big taper of obturation filling system.

Technical:

| | | | | | | |
|---------------|------------------|----------------------------|----------------------------|--------|--------|--------|
| Photo | | | | | | |
| Cross section | Orifice Opener | 12Variable taper Path file | 16Variable taper Path file | 18/.05 | 25/.06 | 35/.04 |
| | | | | | | |
| Model | #17 | #12 | #16 | #18 | #25 | #35 |
| Taper | 12 | 02 | 02 | 05 | 06 | 04 |
| Speed | 300 | 350 | 350 | 350 | 350 | 350 |
| Torque | 3 | 1.5 | 1.5 | 2 | 2 | 1.5 |
| Length | 21 mm/25mm/31 mm | | | | | |

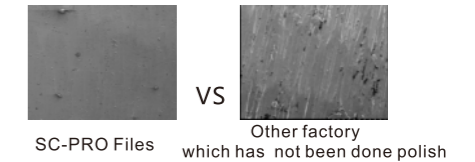

SC-PRO2018 on the basis of the SC-PRO added 06 taper file,
Can face a variety of thickness of the root canal.

Super Easy Operation

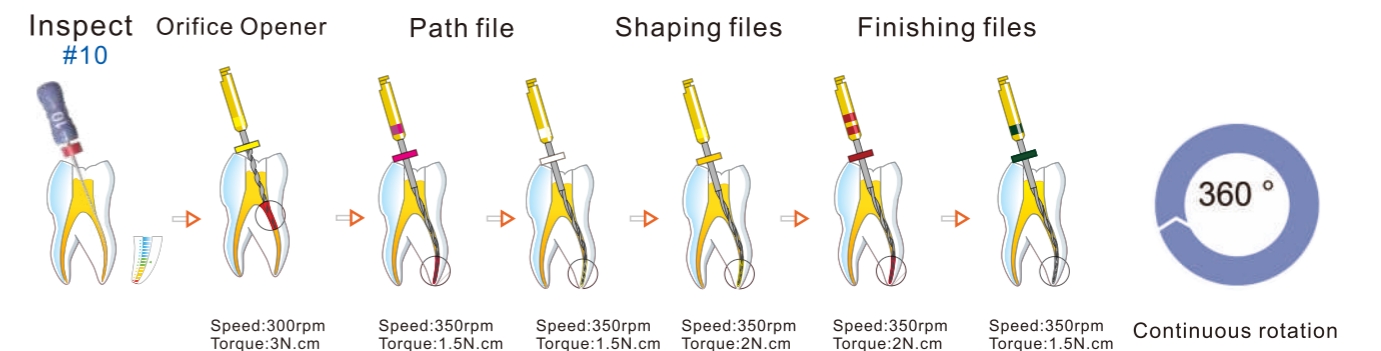

42
NITI file System

S-one PRO
Single Niti Reciprocation File

safer
easier
faster
more effective

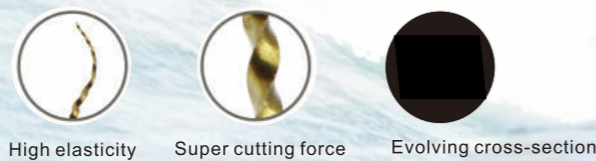

Model: S-one pro

Dental Root Canal Instruments

S-one PRO
Single Niti Reciprocation File



Feature:

1. Super cutting force, anti-fatigue, anti-broken.
2. Maximized cutting efficiency
3. 3pens

Technical:

| | | | |
|---------------|----------------|-------|-------|
| Photo | | | |
| Cross section | 20/07 | 25/07 | 35/06 |
| Model | #20 | #25 | #35 |
| Taper | 07 | 07 | 06 |
| Length | 21mm/25mm/31mm | | |

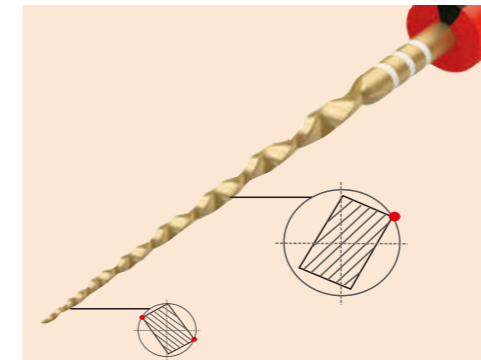

This image depicts how an alternating offset and transitioning parallelogram-shaped cross-section limits the engagement between the file and dentin.

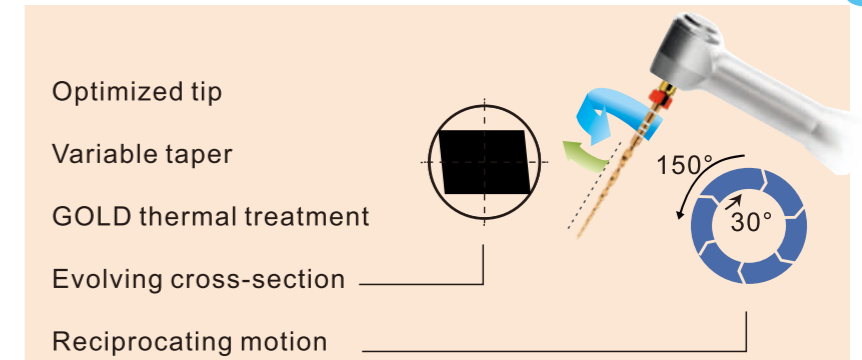

- Optimized tip
- Variable taper
- GOLD thermal treatment
- Evolving cross-section
- Reciprocating motion

Super Easy Operation

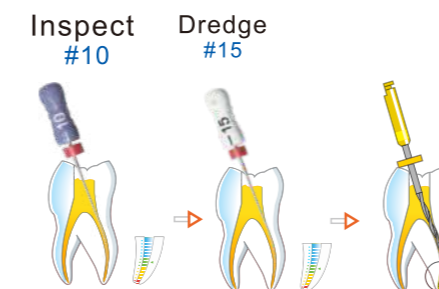

Cutting Efficiency Comparison

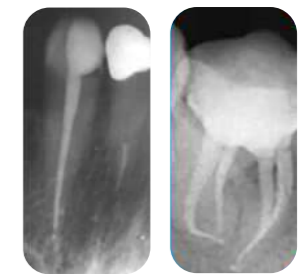

simple complex

SC-PRO Lite 2018
CONTROLLED MEMORY FILES



Safe
Simple
Practical

Feature:

- 1-SC-PRO simplified version is suitable for conventional root canal preparation.
- 2-Anti-cyclic fatigue increased to 400%.
- 3-Safe, simple, practical.
- 4-4 pens

Technical:

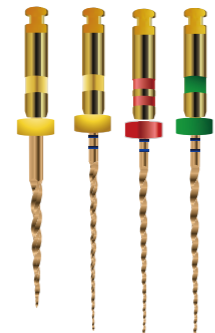

Chimb triangle

| | | | | |
|---------------|----------------|--------|--------|--------|
| Photo | | | | |
| Cross section | Orifice Opener | 18/.05 | 25/.06 | 35/.04 |
| Model | #17 | #18 | #25 | #35 |
| Taper | 12 | 05 | 06 | 04 |
| Speed | 300 | 350 | 350 | 350 |
| Torque | 3 | 2 | 2 | 1.5 |
| Length | 21mm/25mm/31mm | | | |

SC-PRO
CONTROLLED MEMORY FILES



Feature:

- 1-Super cutting force, anti-fatigue, anti-broken.
- 2-The new import CM NiTi material, good flexibility,
- 3-More responsive to the root canal morphology.
- 4-The super-hard alloy coating, increase product durability, and make a perfect looking.

Technical:

| | | | | | | |
|--------|-----------|---------|-----|-----|-----|-----|
| Photo | | | | | | |
| Model | Φ17 | Φ19 | Φ20 | Φ25 | Φ25 | Φ35 |
| Taper | 08 | 02 | 04 | 06 | 04 | 04 |
| Torque | 3.0N.cm | 1.5N.cm | | | | |
| Length | 21mm/25mm | | | | | |

S-one 2018
Single Niti Reciprocation File



Sharp section
High elastic
Quick efficient

Feature:

- 1-Single file to complete the preparation
- 2-Unusually sharp section
- 3-The capacity of chip and chip evacuation enhanced
- 4-More flexible than the traditional single file, indications broader
- A-Good variable pitch design for quick and automatic removal of debris to the crown side.
- B-Variable pitch design and S-section, enhanced transverse cutting force, and weakened instrument "screwed in" dentin effect.
- C-Instrument "screwed in" dentin effect.
- 5-Use 06 taper tooth glue tip filling.

Technical:



simple complex

| | | | |
|-------|----------|----------|----------|
| Photo | | | |
| | L1 20/07 | L1 25/06 | L1 35/06 |
| Model | #20 | #25 | #35 |
| Taper | 07 | 06 | 06 |

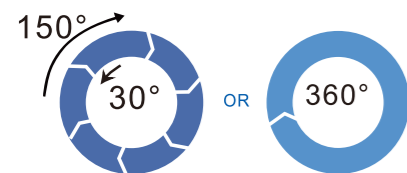

-Three different size finish file,
After predicting the root canal main sharp file,
-According to the fine root canal, middle root canal and rough root canal, Use a single file to complete the preparation

Cutting Efficiency Comparison

切削效果对比图

Traditional Niti File Cutting not enough

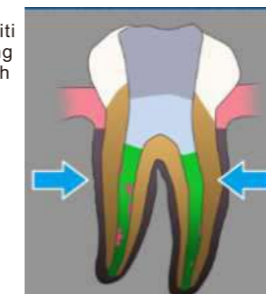

SC-PRO Files Cutting smoothly and equally

SC-PRO



SC-PRO Niti Files

Smoothly and responsively Rotating in the canal

Traditional Niti File

While Rotating, the file will go back to the center, it will easily harm to the canal and make ledge.

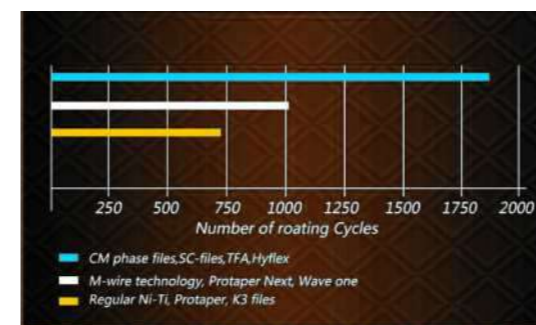

Anti-cycle Fatigue Comparison

New Swiss hard treatment make good per

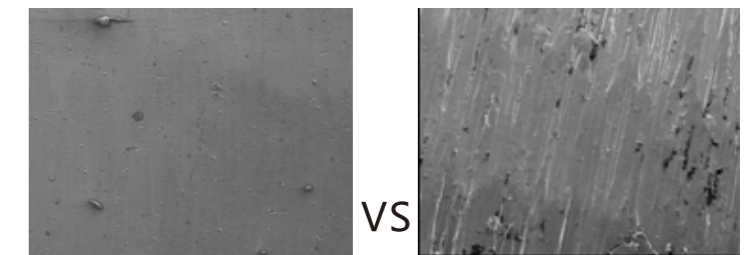

SC-PRO Files

Other factory which has not been done polish

C-FR2 File Removal System

More convenient, safer and less damage

47 File Removal System



Model: C-FR2

File Removal System

Feature:

1. Adopting a lasso style for easier removal of broken files.
2. Strong and secure tip.
3. Ergonomics design.
4. Equipped with standard disinfection box, standard 20 lasso components.

Order code: C-FR2



Standard 20pcs specially designed lasso component
Easy to install and easy to use

Strong and secure tip

Durable and tensile-resistant wire guarantees precise grip safe removal of a broken instrument



48 File Removal System



NiTi Path Drill
Different sizes, to meet your different needs

| | | | | | |
|-------|------|-----|-----|-----|-----|
| | | | | | |
| Model | #110 | #90 | #80 | #70 | #60 |
| Taper | 01 | 02 | 02 | 03 | 04 |

| | | | | |
|-------|---|-----|-----|--|
| | | | | |
| Model | 1.1 | 0.9 | 0.8 | |
| | NiTi Cutting Drill Easy to create a stepped platform | | | |

| | | | | |
|-------|--|---------|---------|--|
| | | | | |
| Model | 0.8x0.5 | 0.6x0.9 | 0.7x1.1 | |
| | Cutting Cannula Remove the dentin around the end of the broken file | | | |

C-FR1 File Removal System

A Product Every Dentist Should Own



49 File Removal System

50 File Removal System

Model: C-FR1

File Removal System

Feature:

1. Adopt clip-on file to minimize damage to teeth.
2. Equipped with three different sizes of work tips and it can meet multiple clinical needs.
3. Pre-bent work tip for easier operation.

Technical:

Volume: 15.5x9.3x5.5cm



Order code: C-FR1

Clip-on file design
To minimize damage to dentin



Special locking design
Help you catch every broken files



Equipped with three different sizes of work tips
Can meet multiple clinical needs.

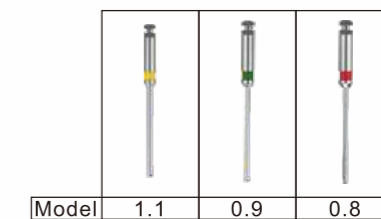

NiTi Flat Drill
Easy to create a stepped platform

NiTi Path Drill
Different sizes, to meet your different needs

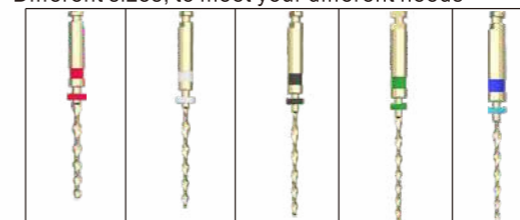

| | | | | | |
|-------|------|-----|-----|-----|-----|
| Model | #110 | #90 | #80 | #70 | #60 |
| Taper | 01 | 02 | 02 | 03 | 04 |

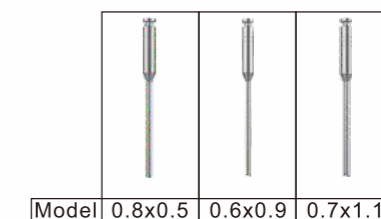

Micro-Trephine
Remove the dentin around the end of the broken file

Feature:

- 1-press rapid heating,release the button a few seconds for cooling,easy to use.
- 2-Using wireless charging technology,stylish,,fashionable.
- 3-2400mAh large capacity nickel cadmium rechargeable battery,avoid frequently charging trouble.
- 4-Fever needle can be sterilized,it can be repeatedly used.

This product has been applied layout-design patent, Counterfeit must be investigated;NO.ZL201430484927.3

Technical:

| | | |
|--------------------------|-------------------------|-----------|
| Ni-MHchargeable Battery: | 1.2V 2700mAh | |
| Heating time: | ≥ 2s | |
| Working temperature: | 160°C | |
| Charger input voltage: | AC230V 50HZ,AC110V 60HZ | |
| Heat plunger | S,M,L,XL | |
| Volume(cm) | 17.5X10.5X7.5 | 15X12X3.8 |
| Weight(kg)/PCS | 0.5 | 0.3 |
| Packing material | carton | carton |
| QTY per master carton | 10 pc/ctn | 10 pc/ctn |



Order code: C-BLADE



Feature:

- Rectilinear motion handpiece and carborundum blade:
- 1-Apply to invisible treatment; rapid repair of dental enamel
- 2-Carborundum blade is stable and durable
- 3-The blade frame and the blade adopts the locking type design, its more solid, has a good compatibility with all kinds of handpiece
- 4-When the knife frame put in to handpiece, can be completely fixed, no shake
- 5-There are holes in the blade, which can effectively discharge the water and powder produced in the glaze.



Order code: C3-11KIT



Different thicknss for the diamond

Technical:

| | | | |
|------------------------------|-------|------|-------|
| Two side diamond (with hole) | 15 μm | 15HD | 2 PCS |
| | 25 μm | 25HD | 2 PCS |
| | 40 μm | 40HD | 2 PCS |
| | 60 μm | 60HD | 2 PCS |
| | 90 μm | 90HD | 2 PCS |

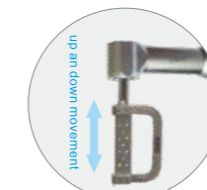

up an down movement



carborundum blade

Push button for remove

Gap measuring ruler
0.10mm 0.15mm 0.20mm
0.30mm 0.40mm 0.50mm

4:1 reduction contra angle

C-CLEAR-2 Stepless Zoom Operating Microscope

See more details and treat more accurately

12.5x Wide-angle Eyepiece

Diopter adjustment

Levelless zoom
(0.4-2.5x)

Larger zoom objective

200mm

250mm

450mm

Model:C-CLEAR-2

Operating Microscope



-Levelless Zoom

More convenient operation,
clearer treatment

-4K Display

Higher-definition display to
assist your training journey



Multiple filter modes

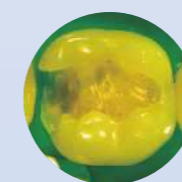

Orange Filter

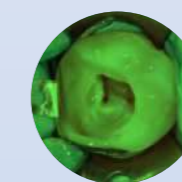

Green Filter



3 Size White Light



Auto power on/off

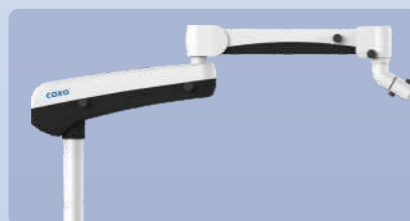

Super Balance Arm System

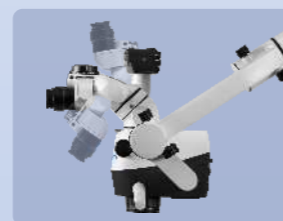

0-180° Variable angle
binocular tube



±30°
Host tilt adjustment

Order code:
C-CLEAR-2
Stepless Zoom

Technical parameters:

1. Optical system: Apochromatic optical system
 2. Zoom System: Levelless zoom(0.4-2.5x)
 3. Eyepiece Lens: 12.5x wide-angle eyepiece, diopter+7~-7D high eye point, suitable for operators with glasses
 4. Binocular tube: 0-180° angle adjustable, f=170mm
 5. Objective Lens: Working distance:200-450mm
 6. Illumination system: LED bulb, adjustable brightness, the illumination is not less than 65000Lux, Color rendering index (Ra/CRI)> 90%
- Multiple filter modes:3 size White light, Orange filter, Green filter

Optional accessories:

External camera system:SLR digital camera

C-CLEAR-2 Operating Microscope

See more details and treat more accurately



Auto power on/off



Super Balance Arm System

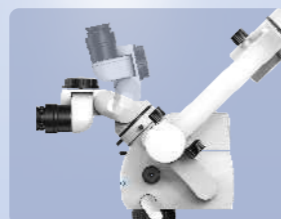

0-180° Variable angle binocular tube



±30° Host tilt adjustment

Model:C-CLEAR-2

Operating Microscope

Multiple filter modes

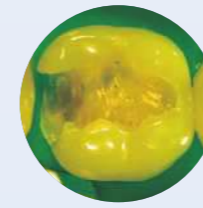

Orange Filter

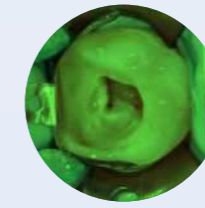

Green Filter



3 Size White Light



Order code:
**C-CLEAR-2
Basic Edition**



Order code:
**C-CLEAR-2
Standard Edition**

Technical parameters:

1. Optical system: Apochromatic optical system
 2. Zoom System: 5 levels of magnification, 0.4/0.6/0.8/1.6/2.5
 3. Eyepiece Lens: 12.5x wide-angle eyepiece, diopter+7~-7D high eye point, suitable for operators with glasses
 4. Binocular tube: 0-180° angle adjustable, f=170mm
 5. Objective Lens: Working distance: 200-415mm
 6. Illumination system: LED bulb, adjustable brightness, the illumination is not less than 65000Lux, Color rendering index (Ra/CRI) > 90%
- Multiple filter modes: 3 size White light, Orange filter, Green filter

Optional accessories:

External camera system: SLR digital camera

Optional mounting options:

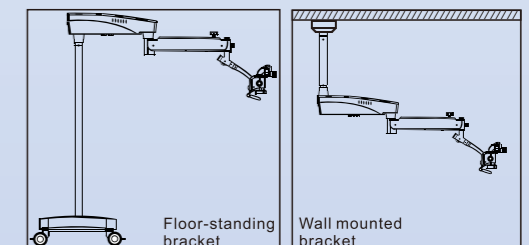

Floor-standing bracket

Wall mounted bracket

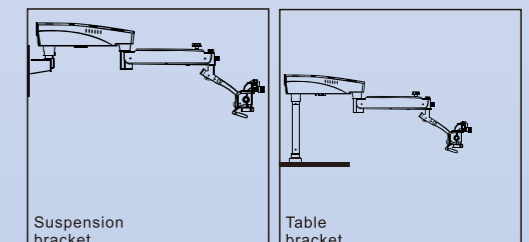

Suspension bracket

Table bracket

Order code: C-PUMA Master

C-PUMA Master Dental electrical motor

Electric motor & Endo motor

One machine multi-use ,Super easy to use!

2 in 1



Brushless LED

Electric motor

With different contra angle, it can be used for teeth preparation, teeth restoration, and teeth polishing, etc.



Endo Motor

with 6:1 Mini head contra angle, it can be used for root canal preparation



Feature:

- 1-The host has a novel shape and streamlined design;
- 2-Full-view color 5-inch LCD display, full touch control;
- 3-Pneumatic / manual start mode free to switch;
- 4-The motor is small and light, and can be autoclave;
- 5-Starting air pressure of the motor can be customized;
- 6-with electric motor and Endo motor function can be switch freely.

Electric Motor Mode Features

- 1-Adapt with contra angle and straight head in accordance with ISO3964
- 2-The speed and steering are adjustable, the speed can reach up to 40,000 rpm.
- 3-Built-in 7 program memories, each program can adjust parameters independently.
- 4-The maximum torque can reach 3.0 N·cm
- 5-Internal water spray;
- 6-The handle is air-cooled to maintain a comfortable temperature;
- 7-LED lighting, light intensity and delay time can be adjusted.

Endo Motor Mode Features

- 1-Use 6:1 contra angle with one-piece Mini head;
- 2-Built-in mainstream file system, no need to set up, just select and use;
- 3-Auto-reverse and manual real-time reverse function;
- 4-Speed: 250-1200RPM;
- 5-Torque: 0.6-5.1 N.cm.

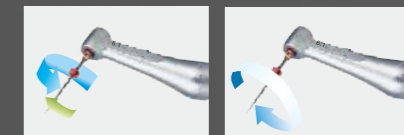

Technical:

- 1-Input power: AC100-240V, 50/60Hz
- 2-5.0 inch LCD screen Resolution: 800*480
- 3-Maximum speed: 40,000 rpm
- 4-Motor outer diameter: 20.6mm

Option:



Order code: C7-3 (1:4.2)

Order code: C7-5 (1:5)

Order code: C-1C (1:1)

Order code: S-2C (1:1)

Order code: C5-1M (6:1)

C-PUMA Dental electrical motor

Minimally invasive repair, polishing.....

Order code: C-PUMA

Feature:

- 1-Simple operating system
Connect the dental unit to the C-Puma with a 4 holes tubing, use the foot pedal to control the electric motor.
- 2-The New-Gen of technology micromotor C-Puma
According to the different treatments and different handpieces, the speed can be adjusted from 100—200,000rpm/min.
- 3-Compact and handy, high torque
Ergonomic designed length and weight greatly reduce the fatigue from long time operation, the motor can be sterilized.

This product has been applied layout-design patent, Counterfeit must be investigated;NO.ZL201430485143.7



Brushless LED

Technical:

| | |
|-----------------------|--|
| Power: | 120w |
| Speed range: | 2000rpm-4000rpm (1:1) 100rpm-2500rpm(16:1) 10000rpm-200000rpm(1:5) |
| LED maximum: | >10000lux |
| Torque output: | 3.5N.CM |
| Volume(cm) | 29X23X11 |
| Weight(kg)/PCS | 2.3 |
| Packing material | carton |
| QTY per master carton | 8 pc/ctn |

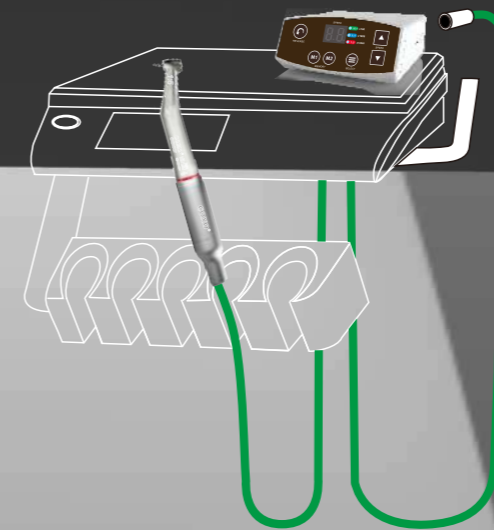

Optional speed ratio: 16:1/1:1/1:5

| RPM | 16:1 | 1:1 | 1:5 |
|---------|-------|--------|---------|
| 100 | 100 | | |
| 1,000 | 2,500 | | |
| 2,000 | | 2,000 | |
| 2,500 | | 40,000 | |
| 10,000 | | | 10,000 |
| 40,000 | | | 200,000 |
| 200,000 | | | |

Option:



- Order code: C7-3 (1:4.2)
- Order code: C7-5 (1:5)
- Order code: C-1C (1:1)
- Order code: S-2C (1:1)

C-PUMA INT+ Dental electrical motor (Built-in Type)

61 Dental Electrical Motors



Brushless LED

- Brushless micro electric motor
- Led light
- Small and compact , with big torque
- With colorful screen ,clear for viewing
- Touch button , easy for operation.
- Built in type which fixed in the working tray, save space.
- Optional speed adjustment



Model: C-Puma

Dental Electrical Motors



Feature:

- 1-Wide viewing angle color LCD screen;
- 2-Big size color LCD,rich information display
- 3-Touch key control, easy to use;
- 4-Built-in, control panel can be easily installed at any angle
- 5-Pneumatic / manual start automatically switch;
- 6-built-in 7 program memory;
- 7-Custom the air pressure of starting motor;
- 8-LED lighting delay off time is adjustable.
- 9-Speed, steering can be adjusted;
- 10-The motor can be autoclaved;

Technical:

| | |
|--|-----------|
| Input power: | AC24V |
| Maximun speed: | 40,000rpm |
| Maximun torque: | 3.0N.cm |
| Fit to ISO3964 contra angle and straight handpiece | |
| 3.0-inch LCD screen resolution: | 240 * 400 |
| Motor diameter: | 20.6mm |

Order code: C-PUMA INT+

Brushless LED

Feature:

- 1-brushless electrical motor,silence and free from maintenance
- 2-Inner channel spray
- 3-LED illumination
- 4-Motor can be sterilized.
- 6-Speed and direction are adjustable.
- 7-LED intensity and delay time are adjustable.

Technical:

| | |
|--|-----------|
| Input: | AC24V |
| Maximun speed: | 40,000rpm |
| Maximun torque: | 3.5N.CM |
| Fit to ISO3964 contra angle and straight handpiece | |
| Volume(cm) | 29X19X7 |
| Weight(kg)/PCS | 0.8 |
| Packing material | carton |
| QTY per master carton | 10 pc/ctn |

Order code: C-PUMA INT

Brushless LED

Option:



Order code:
C7-3
(1:4:2)

Order code:
C7-5
(1:5)

Order code:
C-1C
(1:1)

Order code:
S-2C
(1:1)

62 Dental Electrical Motors

DB686 HALO LED Curing Lights

Comprehensive upgrade of optical systems



63 LED Curing Lights

Model:DB686 HALO

LED Curing Lights

Order code: DB686 HALO

Technical:

| | |
|-------------------------|------------------------------|
| Adapter: | AC100-240V, DC5V 2A, 50/60Hz |
| Wavelength range: | 385~515nm |
| Optical effective area: | 65mm ² |
| LED power: | 10W |
| Lithium battery: | 3.7V 800mAh |



64 LED Curing Lights

more concentrated illumination , stronger penetration, achieving deep solidification

Curing Mode

Low 20s
Low temperature mode

Nor 20s
Normal temperature mode

Tur 01s
Ultra high light intensity mode
Ultra high light intensity, one second curing, efficient curing, Light intensity 3000mW/cm²

Orthodontic Mode

Ort 08c

Dental Carise Mode

Chk 60s

Five modes



DB686 Honor LED Curing Lights

Auto-focusing, more intelligent
Smart handheld power on



65 LED Curing Lights

66 LED Curing Lights

Curing Mode



Normal Curing
Light power: 1200mw/cm²



Low-temp
Unique low-temperature technology
Equal curing effect, temperature lower than normal mode



Focus Curing
Automatic spot focusing during operation

Orthodontic Mode

Light power: > 3000mw/cm²



Dental Carise Mode



Model: DB686 Honor

LED Curing Lights

Order code: DB686 Honor

Technical:

| | |
|-------------------------|-------------------------------|
| Adapter: | AC100-240V, DC5V1.5A, 50/60Hz |
| Wavelength range: | 385~515nm |
| Optical effective area: | 50mm ² |
| LED power: | 10W |
| Lithium battery: | 3.7V 2200mAh |



Curing light focus

Automatic spot focusing during operation



Built-in large-capacity battery
Non-contact recharge



Charging base with the built-in light meter

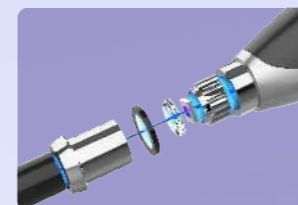

Ultrahigh-intensity
Light intensity up to 3000mW/cm²



Smart handheld power on
Automatic recognition
Double reminder

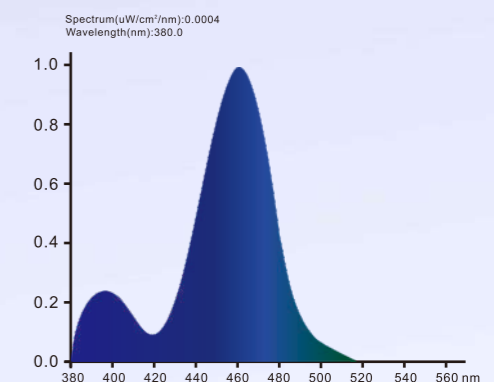

Wavelength: 385-515nm
Suitable for most of the resins in the market

<https://stomshop.pro/>

DB686 NanoLED curing light

Small, just right;
Use, just handy.

Small body, powerful function
Light curing & caries detection

2 in 1

67 LED Curing Lights

Model: DB686 NANO

LED Curing Lights

Order code: DB686 Nano

Technical:

Adapter: AC100-240V, DC5V/1.5A, 50/60Hz
 Light curing mode:
 Wavelength: 380-520nm
 Curing time: 10s/20s
 Curable depth: 8mm
 Caries detection mode:
 Wavelength: 380-420nm



LED light measure system

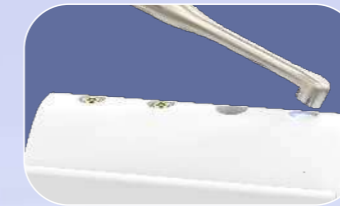

Ultra-small all-metal body
outer diameter of only 13.5mm

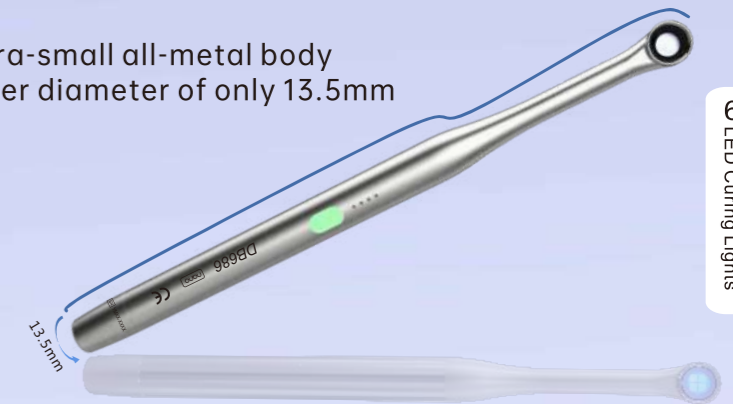

68 LED Curing Lights

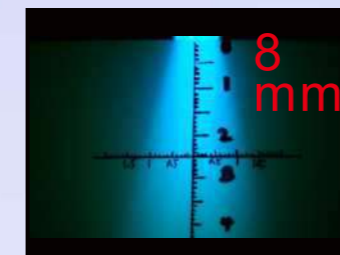
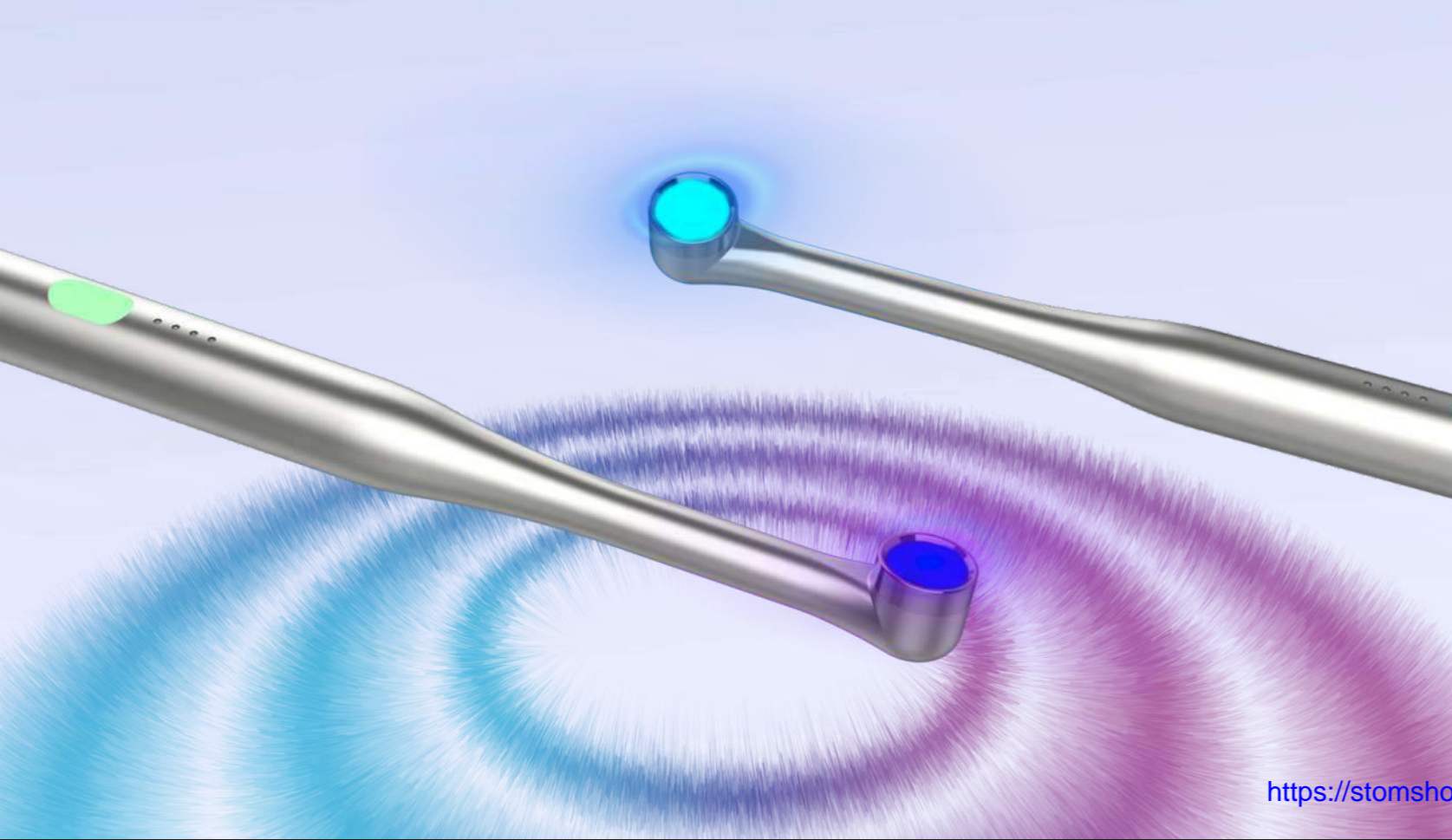

8 mm deep curing depth
Curing effect into every corner

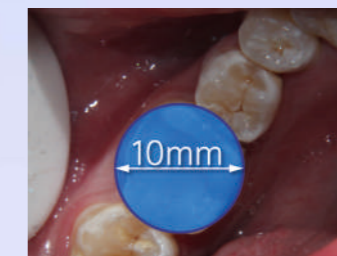

10mm diameter
large area light emission

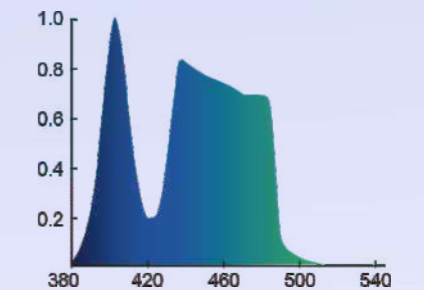

Wavelength: 380-520nm
Suitable for most of the resins in the market

Detection mode:
Simple, Effctive
Innovative caries detection

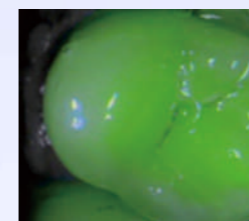

Green: Healthy

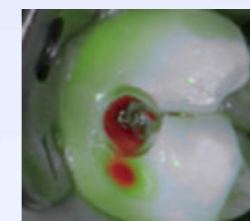

Red: Bacterial dentin

Nano can maintain strength even if it is not focused on the center.
Curing at any angle can also ensure the effect

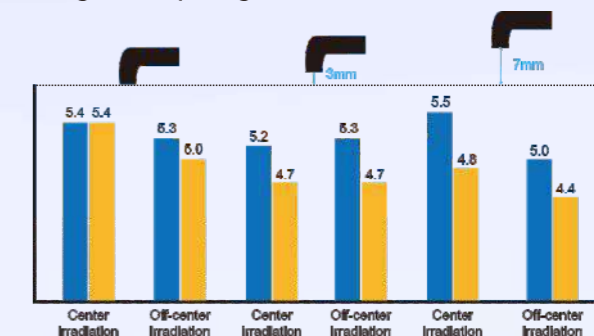

DB686 Swift LED curing light

Curing & Orthodontic LED light
Smaller, Stronger

2 in 1

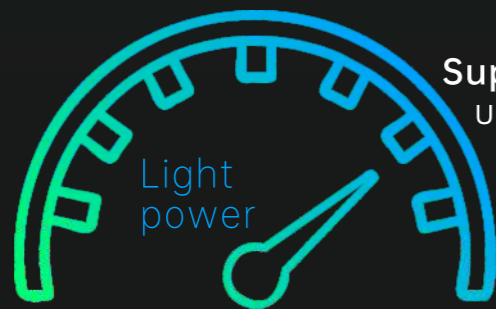

Super power
Up to 3000mw/cm²

Light power

Model: DB686 Swift

LED Curing Lights

Order code: Db686 Swift

Technical:

| | |
|-------------------|------------------------------|
| Adapters: | AC100-240V, 50/60Hz |
| Wide spectrum: | 385-515nm |
| Curing time: | 5s/10s/15s/20s(Soft up mode) |
| | 5s(High power mode) |
| | 1-8times(Orthodontic mode) |
| Volume(cm) | 19x12x5 |
| Weight(kg)/PCS: | 0.54 |
| Packing material: | Carton |

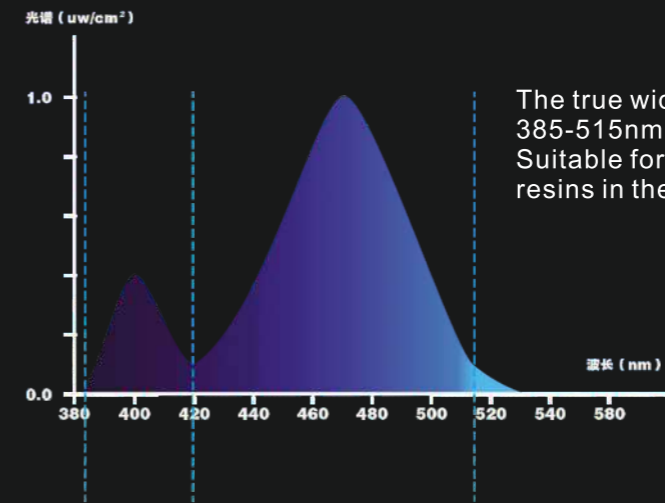

- 10mm large area light emissi
- 8mm deep curing depth

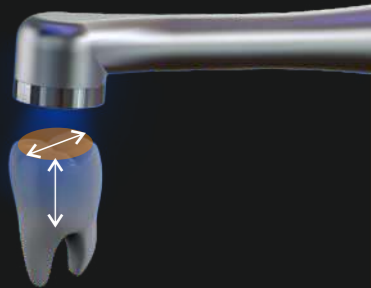

Soft up mode
Light power: 1000mw/cm²
Working time: 5s/10s/15s/20s



High power mode
Light power: >2000mw/cm²
Working time: 5s



Orthodontic mode
Light power: >3000mw/cm²
Working time: 1-8times



Super focus light



Model: DB686 Deli

LED Curing Lights



- Purple
- Green
- Blue
- Black



Order code: DB686 DELI

Feature:

- 1-High power LED, purely dental blue light.
- 2-High articulation optical fiber.
- 3-Digital display, Clear and intuitive operation.
- 4-Three working modes: strong, gradually strong, flashing.
- 5-Optional working time: 5sec, 10sec, 15sec, 20sec.
- 6-Automatic inactive, automatic power off.
- 7-Low battery detection.
- 8-Removable large capacity Li-ion battery.
- 9-Soft pushbutton, nice feel.

Technical:

| | |
|--------------------------------|--------------------|
| Charger working voltage: | AC100-240V,50/60Hz |
| wavelength:: | 420-480nm |
| Solidification time and depth: | 5s3mm |
| Volume(cm) | 23X13X5.5 |
| Weight(kg)/PCS | 0.6 |
| Packing material | carton |
| QTY per master carton | 10 pc/ctn |

Application:

Solidify all brands of resin materials.

Model: DB686 Latte



Order code: DB686 LATTE

Feature:

- 1-High power LED, purely dental blue light
- 2-Digital display, adjustable work time
- 3-High capacity rechargeable Li-ion battery ,low battery detection
- 4-Low-power,long standby time
- 5-Over-temperature protection,light source detection

This product has been applied layout-design patent, Counterfeit must be investigated;NO.ZL200830107969.4

Technical:

| | |
|--------------------------------|--------------------|
| Charger working voltage: | AC100-240V,50/60Hz |
| wavelength:: | 420-480nm |
| Solidification time and depth: | 5s3mm |
| Volume(cm) | 24X19X9 |
| Weight(kg)/PCS | 0.6 |
| Packing material | carton |
| QTY per master carton | 10 pc/ctn |

Application:

Solidify all brands of resin materials.

This product has been applied layout-design patent. Counterfeit must be investigated.

Model: DB686 Penguin

LED Curing Lights



Order code: DB686 PENGUIN



Feature:

- 1-High power LED,professional dental spectrum.
- 2-Bionic design,LCD display.
- 3-Optional working mode: strong, low, gradually strong, flashing.
- 4-Solidifying time:5-40s,can be adjustable.
- 5-Temperature inspect, over-temperature protection.
- 6-High capacity Li-ion battery , and can charge with charge. base or adaptor.
- 7-Wireless and corded are compatible in one
- 8-Built-in high sensitive LED light measure system.
- 9-Handle can put on the tool tray with the holder.

Technical:

| | |
|--------------------------------|--------------------|
| Charger working voltage: | AC100-240V,50/60Hz |
| wavelength:: | 420-480nm |
| Solidification time and depth: | 5s3mm |
| Volume(cm) | 24X22.5X9.5 |
| Weight(kg)/PCS | 1.5 |
| Packing material | carton |
| QTY per master carton | 6 pc/ctn |

Application:

Solidify all brands of resin materials.

This product has been applied layout-design patent, Counterfeit must be investigated;NO.ZL2010930080816.X

Model: DB686 1b



corded



Style A
Input:AC12-24V

wireless



Free Connecting the main unit to use as cord style with adaptor. Free Coupling For Corded Use

Order code: DB686-1b

Feature:

- 1-Dental special high power LED
- 2-High articulation optical fiber
- 3-Three working modes:strong,gradually strong,flashing
- 4-Optional working time:10sec,15sec,20sec
- 5-Automatic inactive,automatic power off
- 6-Low battery alert
- 7-Super capacity battery
- 8-Membrane pushbutton,soft feel

This product has been applied layout-design patent, Counterfeit must be investigated;NO.ZL201073052828.2

Application:

Solidify all brands of resin materials.

Technical:

| | |
|--------------------------------|--------------------|
| Charger working voltage: | AC100-240V,50/60Hz |
| wavelength:: | 420-480nm |
| Solidification time and depth: | 5s3mm |
| Volume(cm) | 23X13X5.5 |
| Weight(kg)/PCS | 0.6 |
| Packing material | carton |
| QTY per master carton | 10 pc/ctn |

Model: DB686 Super-Lux

LED Curing Lights



Feature:

- 1-Dental special high power LED
- 2-Optional light intensity:strong,medium,low
- 3-Optional working mode:fixed,gradually strong,flashing
- 4-Time : 5 seconds to 30 minutes.
- 5-high-capacity lithium-ion battery, battery check function

This product has been applied layout-design patent, Counterfeit must be investigated;NO.ZL201220344676.9

Technical:

| | |
|--------------------------------|--------------------|
| Charger working voltage: | AC100-240V,50/60Hz |
| wavelength:: | 420-480nm |
| Solidification time and depth: | 5s3mm |
| Volume(cm) | 24X19X9 |
| Weight(kg)/PCS | 1.0 |
| Packing material | carton |
| QTY per master carton | 6 pc/ctn |

Order code: DB686 SUPER-LUX

Application:

Solidify all brands of resin materials.

Model: DB686 Super-Dual



Feature:

- 1-high power LED, dentistry dedicated spectrum
- 2-streamlined design, LCD display and
- 3-both the light-curing treatment and teeth whitening
- 4-3 light intensity profiles are available: light, medium, low
- 5-3 operating modes: bright, fade, blink
- 6-time: 5 seconds to 30 seconds to select
- 7-high-capacity lithium-ion battery, battery check function
- 8-built-in high sensitive LED metering system

Technical:

| | |
|--------------------------------|--------------------|
| Charger working voltage: | AC100-240V,50/60Hz |
| wavelength:: | 420-480nm |
| Solidification time and depth: | 5s3mm |
| Volume(cm) | 24X19X9 |
| Weight(kg)/PCS | 1.0 |
| Packing material | carton |
| QTY per master carton | 6 pc/ctn |

Order code: DB686 SUPER DUAL

Application:

Solidify all brands of resin materials.



Model: C-Bright

Teeth Whitening Accelerator

Feature:

- 1-new-style structure and unique form, compact and elegance
- 2-Double handles, drug type arm,multi-angle adjustment to make the operate more flexibly
- 3-Unique semi-circular head design, both arches whitened at the same time
- 4-6pcs high power LED, fan-cooled
- 5-10s and 30s as a curing ligh, 1-30minutes as a whitening accelerator
- 6-6 light intensities,suitable for more brands tooth whitening gel
- 7-LCD module screen shows all the information, all the operation is so easy
- 8-Chairside type is available

Technical:

| | |
|-------------------|--|
| Input power: | AC100-240V,50/60Hz |
| Light resource: | 6pcs high power LED |
| Wavelength: | 420nm-490nm |
| Light intensity: | 6 intensities,maximum>6000mW/cm ² |
| Adjustable timer: | 10s,30s,1m,2m,5m,8m,10m,15m,20m,30m |



Order code: C-BRIGHT

This product has been applied layout-design patent. Counterfeit must be investigated. ZL201030178145.3 ZL201220344678.9

| | C-bright | C-bright-b |
|------------------|------------------------------|----------------------------|
| Volume(cm) | base:63x63x23, arm:100x26x27 | base:22x18x3 arm: 52x52x22 |
| Weight(kg)/PCS | 20.0kg | 0.13kg 6.0kg |
| Packing material | | carton |

Feature:

- 1-simple,light and handy moldin design.
- 2-Hand-held and fixed dual-use two design,freely to adjust to any angle position
- 3-Unique aemi-cicular head design,both arches whitened at the same time.
- 4-6 pcs high power LED,fan-cooled.
- 5-1-0 minutes adjustable timer,3 light intensities,suitabl for more brands tooth whitening gel
- 6-Led screen shows all the information,all the operation is so easy
- 7-Integrated type is available

This product has been applied layout-design patent, Counterfeit must be investigated;NO.ZL201030178149.1

Technical:

| | |
|-------------------|--|
| Input power: | AC100-240V,50/60Hz |
| Light resource: | 6pcs high power LED |
| Wavelength: | 420nm-490nm |
| Light intensity: | 3 intensities,maximum>6000mW/cm ² |
| Adjustable timer: | 1m,5m,8m,10m,15m,30m |



Order code: C-BRIGHT-1a

| | C-bright-1a | C-bright-1 |
|------------------|------------------------------|------------|
| Volume(cm) | base:54x54x24, arm:100x14x12 | 52x52x22 |
| Weight(kg)/PCS | 9.0kg | 5.5kg |
| Packing material | | carton |

Dental Alginate Mixer

Feature:

- 1-Streamline modelling, perfect design, smart construction
- 2-electric lock and motor brake gear ensure operational security
- 3-High-power and high-speed motor, fine viscosity and perfect mixture
- 4-Easy to operation,harmonious, no bubbles
- 5-3 programs setting for memory the mixing time (Install setting: 6, 8, 10 seconds)

Technical:

| | |
|------------------|--------------------------------|
| Voltage: | AC110V 50/60HZ; AC220V 50/60HZ |
| Consumer power: | 350-400W |
| Wavelength: | 420nm-490nm |
| Timer: | 1-16seconds |
| Revolution: | 3000-3600 R.P.M. |
| Volume(cm) | 40x33x45 |
| Weight(kg)/PCS | 26.0kg |
| Packing material | wooden |



Order code: DB-988

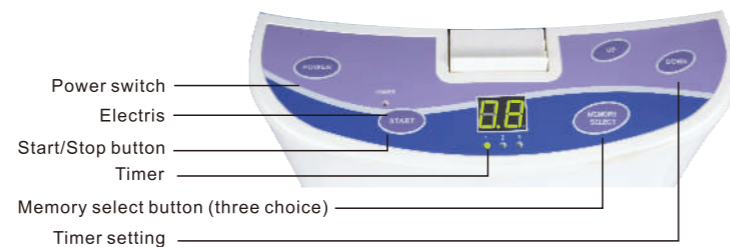

1. Accelerator built on mixing bowl cap



2. Measure the correct amount of alginate&water for use



3. Close tightly the cap of mixing bowl



4. Place it into the well of Alginate mixer



5. Press down the key "ST/STOP" to start running



6. Take out the mixture by the spatula



Amalgamators

Feature:

- 1-This kind of amalgamator, controlled by a microprocessor, ensures a precise, controlled, consistent mix.
- 2-With the width of the oscillating range, the mixing frequency, and your selected time(1-99S).
- 3-It's revolve according to "8" model.
- 4-For mercury-based fillings. trust the performance of DB338 amalgamator. Together, it provides the clinical perfection you need with the ease-of-use you want.
- 5-For safe operation, the DB338 deactivates when you open the front cover to access the capsule.
- 6-Its ergonomic design is easy to use, stable, extremely quiet and easy to clean and maintain



Order code: DB-338

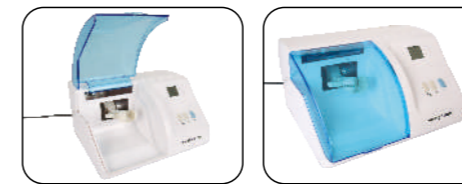

Technical:

| | |
|---------------------------|--|
| Voltage: | 220 V / 50 Hz(110 V / 60 Hz are available) |
| Absorbed power: | 200W Fuse 2A |
| Mixing frequency: | >3400tr/mn(rpm) |
| Noise: | <65dB |
| Programmable mixing time: | 1-99sec. |
| Volume(cm) | 33x27x20 |
| Weight(kg)/PCS | 4.5kg |
| Packing material | carton |

Ultrasonic cleaners

Technical:

| | | |
|-------------------------------|--|--|
| Tank capacity | 6000ML (1.6 gallon US) | Max.5000ml/1.3gallon (US) Min.3350ml / 0.9gallon(US) |
| Tank Size | 33.1X23.8 X10.5CM/ 13.0"X9.4"X4.1" | |
| Longest Item Fits Inside Tank | 34.0CM/13.4" | |
| Power | 290 W (AC100~120V 60Hz) 310W (AC220~240V 50HZ) 270W (AC100V 50/60Hz) | |
| Digital timer | 1 to 30-minute full range timer | |
| Drainage | Drainage valve | |
| Ultrasonic Frequency | 35,000Hz | |
| Tank Weight | Stainless steel SU 304 | |
| Net Weight | 9.3kg/20.7lb | |
| Gross Weight | 10.9kg/24.2lb | |
| Inner Box Size | 50.5x36.0x25.0cm/17.2"x11.8"x 9.8 " | |
| Master Carton Size | 52.0 x37.5 x66.0cm/20.0"x14.8"x26.0" | |



Order code: DB-4860

Ultrasonic cleaners

Technical:

| | |
|----------------------|--|
| Ultrasonic Frequency | 42,000 Hz |
| Tank Material | Stainless Steel SUS304 |
| Tank Capacity | 2500 ml |
| Timer | Digital timer with 5 cycles (180/280/380/480/90 seconds) |
| Power Supply | AC 100 ~ 120V, 50 / 60Hz AC 220 ~ 240V, 50 / 60 Hz |
| Power | 160 W(AC110V-120V);170W(AC220V-240V) |
| Unit Size | 35X26X23 cm (L x W x H) |
| Unit N.W. | 3KG |



Order code: DB-4820

PT Master Dental Scaler and Air Polisher

Powerful
More intelligent

2 in 1

77 Dental Scaler and Air Polisher



Model:PT Master

Dental Scaler and Air Polisher

Order code: PT Master

Technical:

| | |
|--------------------------------------|----------------------|
| Adapter: | AC100-240V50/60Hz |
| Input power: | 80VA |
| Operating mode: | Continuous operation |
| Ultrasonic Tips vibration offset: | <200um |
| Ultrasonic Tips vibration frequency: | 24-36 kHz |
| Half offset force: | ≥0.5N |
| Ultrasonic Tips output power: | 0.8-13w |
| Input pressure: | 0.55-0.7Mpa |
| Weight: | 3kg |
| Control unit size: | 30×26×13cm |

Scaler Tips:

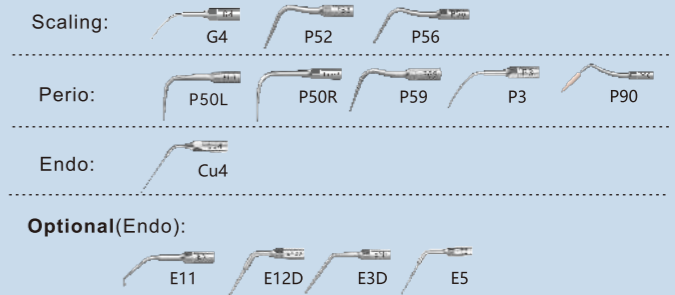

78 Dental Scaler and Air Polisher

Handpiece intelligent recognition system

Pick up the handle and automatically switch to working mode



Small caliber nozzle
More accurate scaling



Large bottle design
Design of funnel-shaped powder chamber, Smoother use, 1000ml water storage bottle

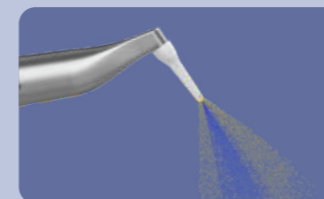

3 hole sandblasting
More concentrated sandblasting, Reduce sand powder flying



Segmented design
Simple disassembly, Convenient cleaning

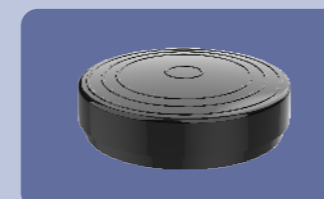

Wireless Multi-purpose pedal
Not limited by angle, convenient and easy to use



LED ultrasonic handpiece
Safe and durable

CP-1 Dental Air Polisher

Comfortable and clean
Better sandblasting effect
Supragingival & subgingival mode Two-in-one

2 in 1

Order code: CP-1

Technical:

| | |
|-----------------------------------|------------|
| Input air pressure: | 250-450kPa |
| Input water pressure: | 70-220kPa |
| Water flow: | > 30ml/min |
| Nozzle caliber for power measures | 0.7mm |
| Nozzle caliber for water measures | 1.4mm |
| Weight: | 145g |



Supragingival & subgingival mode
Two-in-one

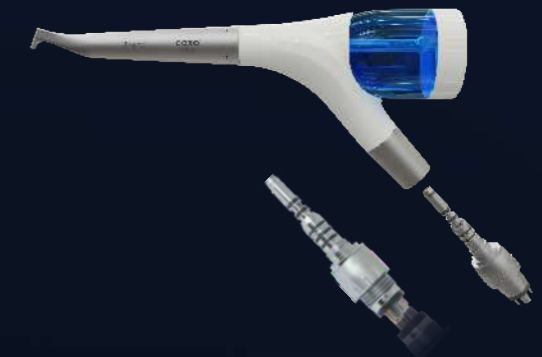

360° rotation
Removable for easy cleaning
and maintenance



Sectional design
simple loading and unloading
easy to clean and maintain

360° viewable
Transparent powder container enables
easier observation of remaining powder

79 Air Abrasion System with spray

80 Air Abrasion System with spray

DP-1/ DP-2/ DP-3 Prophylaxis Powder

3 major series & 4 specifications
Meet various needs
Improve treatment efficiency

Model:DP-1/ DP-2/ DP-3

Prophylaxis Powder



65um Sodium Bicarbonate

Order code: DP-1
Particle size: 65um
Net:300g
Supragingival application
Product Flavor:Lemon /Strawberry
Sodium bicarbonate has an anti-inflammatory and anti-caries effect, with a Mohs hardness of 2.5. It is a quick and easy scaling method. The hardness remains between the enamel and dentin. It can easily clean plaque and stubborn pigments on the gums without damaging the teeth.



14um Erythritol

Order code: DP-3(14um)
Particle size: 14um
Net:120g
Supragingival & Subgingival application
The average diameter of Erythritol powder particles is 14 microns. The very fine powder can clean teeth in a minimally invasive manner without damaging tooth enamel, root surface cementum and soft tissue. Erythritol antibacterial and anti-caries contains 0.3% chlorhexidine, which can effectively prevent and treat gingivitis and periodontitis.



25um Glycine

Order code: DP-2(25um)
Particle size: 25um
Net:120g
Supragingival & Subgingival application
Glycine itself is slightly sweet and has a pleasant taste. The Mohs hardness is only 2.0, which is smaller than dentin. It has a gentle effect. The average particle diameter is only 25 microns. It is a fine particle. It can be used for subgingival scaling, periodontal and peri-implant cleaning in minimally invasive scaling and maintain



65um Glycine

Order code: DP-2(65um)
Particle size: 65um
Net:200g
Supragingival application
Glycine itself is slightly sweet and has a pleasant taste. Its Mohs hardness is only 2.0, which is smaller than dentin and has a gentle effect. It can be used on natural gum plaque and stubborn pigments without damaging teeth

81 Prophylaxis Powder

82 Prophylaxis Powder





CA-1 Air Abrasion System with spray

Dry and wet dual-use
 Better sandblasting effect
 Better moisture-proof effect

Model: CA-1

Air Abrasion System with spray

Order code: CA-1(M4) 
 CA-1(B2) 

Feature:

1. Built in unique design negative pressure balance gas path structure, effectively prevent external moisture into the sand bottle, prevent sand powder from moisture
2. Unique multi-point water spray design, External intersection, Effectively prevent back suction plugging hole and prevent sand powder from damp
3. The nozzle is made of tungsten steel with long service life
4. The nozzle seat can rotate 360° and is detachable for easy cleaning and maintenance

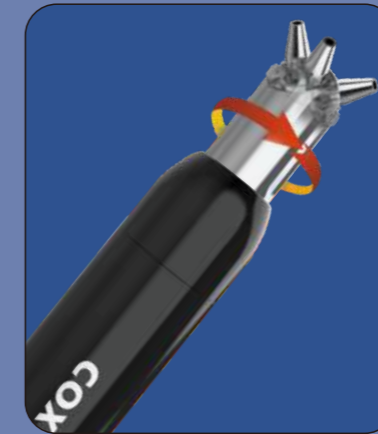

360° rotation
 Removable for easy cleaning and maintenance



Humanized Button Design
 It is more comfortable to press with your index finger

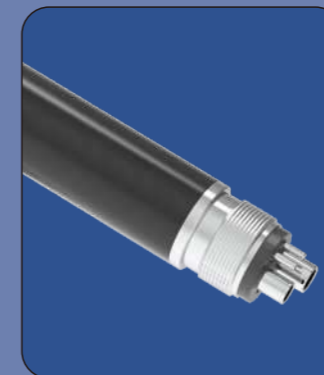

Standard 4-hole design
 Easy connect, easy to use

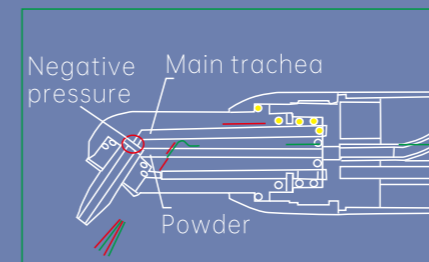

Negative pressure balance design
 Effectively prevent sand powder from getting damp

Unique multi-point water and air mixing outside, better effect and better moisture resistance



TP-1 Dental Polisher

Model: TP-1

Dental Polisher

Order code: TP-1

Technical:

| | |
|---------------------------|---------------------|
| Adaptor working voltage | AC100-240V 50/60HZ; |
| Adjustable torque, range | 0.9N.cm |
| rotational speed ranging: | 500-5000rpm |
| Volume(mm) | 130.2×23.4×20.5 |
| Weight(kg)/PCS | 2.8 |
| Packing material | carton |
| QTY per master carton | 6pc/ctn |

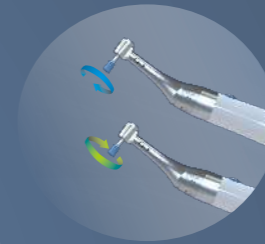

85 Dental Polisher

86 Dental Polisher

GENI Dental Anesthesia Booster

Wireless handheld
Stable injection
Intelligent

Order code: GENI

Technical:

| | |
|---------------------------------|--|
| Adaptor working voltage: | Input:100-240V 50/60Hz Output: DC5V, 2A |
| Handpiece lithium battery: | 3.7V 220mAh |
| Charging stand lithium battery: | 3.7V 800mAh |
| Operation mode: | Short time |
| Volume: | 2.3×2.3×16.5cm |
| Weight: | 80g |
| Packing material: | Carton |



3 Boost Modes

High-precision stable injection

Injection rate (1.8ml per injection)

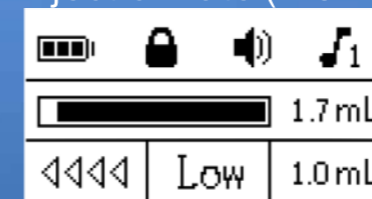

•About 285s•



•About 130s•

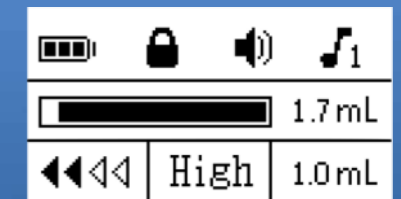

•About 89s•



•Soft touch control
Induction injection, more convenient for dentist to use



•Manual aspiration
Clear display interface at a glance



•Music prompts
Soothe patients get safe treatment

ACCESSORY OF Electric Equipment

Pulp tester

For C-PULSE

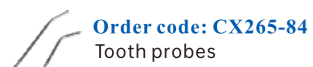

Order code: CX265-84
Tooth probes

Root Apex Locators

For C-ROOT I



Order code: CX265-19
Test wire

Order code: CX265-17
Lip hook

Order code: CX265-52
File holder

Order code: CX265-29
Adapter(DC5V, 1A)

For C-ROOT I(VI)



Order code: CX265-21
Tooth probes

Order code: CX265-22
Test handle

Order code: CX265-16
Text wire

Order code: CX265-17
Lip hook



Order code: CX265-20
Battery

Order code: CX265-28
Adapter(DC10V, 1.5A)

Order code: CX265-18
File holder

Endodontic Obturation System

For C-FILL MINI



Order code: CX265-70
Heat plunger

Order code: CX265-2
Gun needle

Order code: CX265-71
Thermal protector cap

Order code: CX265-27
Adapter(DC5V, 1.5A)



Order code: CX265-4
Multi-tool

For C-FILL



Order code: CX265-1
Heat plunger

Order code: CX265-2
Gun needle

Order code: CX265-3
Thermal protector cap

Order code: CX265-27
Adapter(DC5V, 1.5A)



Order code: CX265-4
Multi-tool

Root Canal Irrigation & Suction System

For C-RCC



Order code: CX265-86
Tip A (C-RCC)

Order code: CX265-87
Tip B (C-RCC)

Endo Ultrasonic Activator

For ULTRA-SMART



Order code: CX265-79
Working tip (CU1)

Order code: CX265-80
Wrench

Order code: CX265-81
Rubber sleeve

Order code: CX265-27
Adapter(DC5V, 1.5A)

For ULTRA-SMART AI



Order code: CX265-79
Working tip (CU1)

Order code: CX265-92
Working tip (CU2)

Order code: CX265-93
Working tip (CU3)

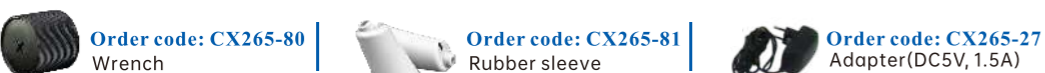

Order code: CX265-80
Wrench

Order code: CX265-81
Rubber sleeve

Order code: CX265-27
Adapter(DC5V, 1.5A)

Endo motors

For C-SMART-PILOT

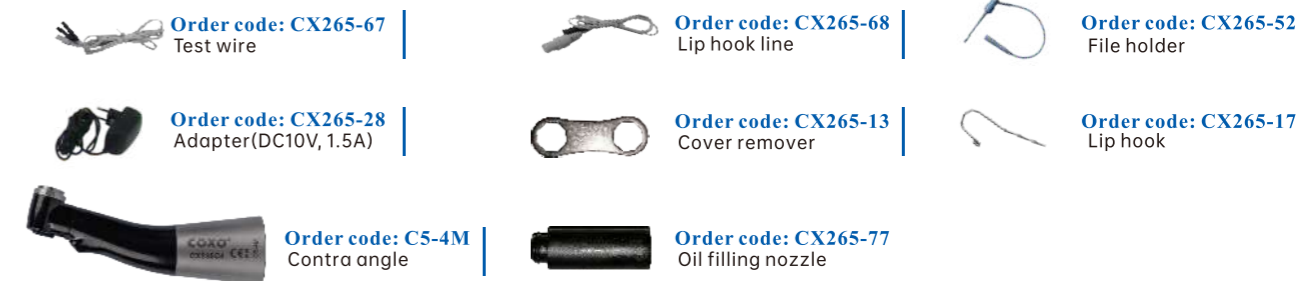

Order code: CX265-67
Test wire

Order code: CX265-68
Lip hook line

Order code: CX265-52
File holder

Order code: CX265-28
Adapter(DC10V, 1.5A)

Order code: CX265-13
Cover remover

Order code: CX265-17
Lip hook

Order code: C5-4M
Contra angle

Order code: CX265-77
Oil filling nozzle

For C-SMART-IPRO

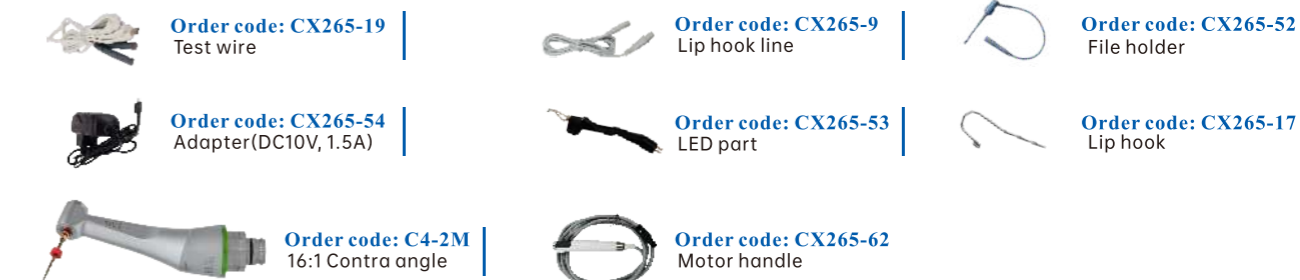

Order code: CX265-19
Test wire

Order code: CX265-9
Lip hook line

Order code: CX265-52
File holder

Order code: CX265-54
Adapter(DC10V, 1.5A)

Order code: CX265-53
LED part

Order code: CX265-17
Lip hook

Order code: C4-2M
16:1 Contra angle

Order code: CX265-62
Motor handle

For C-SMART-MINI AP



Order code: CX265-67
Test wire

Order code: CX265-68
Lip hook line

Order code: CX265-52
File holder

Order code: CX265-28
Adapter(DC10V, 1.5A)

Order code: CX265-13
Cover remover

Order code: CX265-17
Lip hook

Order code: C4-2M
Contra angle

Order code: CX265-77
Oil filling nozzle

For C-SMART-MINI/C-SMART-MINI(LED)



Order code: CX265-55
LED part

Order code: CX265-28
Adapter(DC10V, 1.5A)

Order code: CX265-77
Oil filling nozzle

Order code: CX265-13
Cover remover

Order code: C1-16M
1:1 Contra angle
For C-SMART-MINI

Order code: C1-17M
1:1 Contra angle
For C-SMART-MINI(LED)

For C-SMART-I



Order code: CX265-8
Contra angle holder

Order code: CX265-9
Lip hook line

Order code: CX265-52
File holder

Order code: CX265-28
Adapter(DC10V, 1.5A)

Order code: CX265-10
Battery

Order code: CX265-17
Lip hook

Order code: CX265-60
Test wire

Order code: CX265-77
Oil filling nozzle

Order code: CX265-13
Cover remover

Order code: C1-17M
1:1 Contra angle

File Removal System

For C-FR1



Order code: CX265-88
For C-FR1 work tip

Order code: CX265-89
For C-FR1 NiTi Path Drill

Order code: CX265-90
For C-FR1 Flat Drill

Order code: CX265-91
For C-FR1 Trepine





Ultrasonic Surgery System

For C-EXPLORER





| | | |
|---|--|--|
|  Order code: CX265-38 Water supply pipe |  Order code: CX265-94 Handpiece with wire |  Order code: CX265-95 Basic handpiece tips kit |
|  Order code: CX265-96 Torque wrench |  Order code: CX265-97 Handpiece holder |  Order code: CX265-98 Pedal |
|  Order code: CX265-99 Sterilization case |  Order code: CX265-100 Tip holder | |
|  Order code: CX265-101 US1 Tip |  Order code: CX265-102 US2 Tip |  Order code: CX265-103 US4 Tip |
|  Order code: CX265-104 US5 Tip |  Order code: CX265-105 UL3 Tip |  Order code: CX265-106 UC1 Tip |

Dental Implantation system

For C-SAILOR PRO













| | | |
|---|--|--|
|  Order code: CX265-38 Water supply pipe |  Order code: CX265-64 Motor with wire |  Order code: CX265-63 Foot control |
|  Order code: C6-22 Optic fiber 20:1 contra angle | | |

For C-SAILOR

| | | |
|--|--|--|
|  Order code: CX265-38 Water supply pipe |  Order code: CX265-40 Motor with wire |  Order code: CX265-41 Foot control |
|  Order code: C6-23 20:1 contra angle | | |

Dental Scaler and Air Polisher

For PT-MASTER

| | | |
|--|--|--|
|  Order code: CX265-107 G4 Tip |  Order code: CX265-108 P52 Tip |  Order code: CX265-109 P56 Tip |
|  Order code: CX265-110 P50L Tip |  Order code: CX265-111 P50R Tip |  Order code: CX265-112 P59 Tip |
|  Order code: CX265-113 P3 Tip |  Order code: CX265-114 P90 Tip |  Order code: CX265-115 Cu4 Tip |
| Optional: | | |
|  Order code: CX265-116 E11 Tip |  Order code: CX265-117 E12D Tip |  Order code: CX265-118 E3D Tip |
|  Order code: CX265-119 E5 Tip | | |

Dental Electrical Motors

For C-PUMA Series

| | |
|--|---|
|  Order code: CX265-75 Micro motor |  Order code: CX265-43 Adapter(DC30V, 4A) |
|--|---|

LED Curing Lights

Optical fiber

| | | |
|---|---|--|
|  order name: CX233-3 for 686/DB-686-1 |  order name: CX233-6 for 686 LATTE/CAPPU |  order name: CX233-7 for 686 SUPER LUX/ SUPER DUAL |
|  order name: CX233-8 for 685 PENGUIN/ 686 DELI |  order name: CX233-10 for hunter(90°) |  order name: CX233-11 for hunter(120°) |
|  order name: CX265-78 for 686 NANO |  order name: CX265-85 for 686 SWIFT | |

Battery

| |
|---|
|  Order code: CX265-45 Battery for DB686 DELI |
|  Order code: CX265-46 Battery for DB686 LATTE |
|  Order code: CX265-48 Battery for DB686 PENGUIN |
|  Order code: CX265-49 Battery for DB686 SUPER DUAL |
|  Order code: CX265-50 Battery for DB686-1b |
|  Order code: CX265-72 Battery for DB686 NANO |

Other Accessories

| | |
|---|--|
|  Order code: CX265-73 Head cover |  Order code: CX265-51 Eye protection unit |
|  Order code: CX265-74 Diagnostic goggles | |

Other Accessory

| | | |
|---|---|---|
|  Order code: CX265-58 Gutta percha trimmer |  Order code: CX265-56 Disinfection box |  Order code: CX265-25 Cleaning table-board |
|  Order code: CX265-57 File rack with measuring ruler |  Order code: CX265-23 File rack with measuring ruler |  Order code: CX265-24 Measuring ruler |
|  Order code: CX265-33 Root canal plastic module | | |

X TITAN SUPER TORQUE

*special design of cartridge and air duct
more stable, more quiet, more powerful*

The super torque is bigger than most other brand

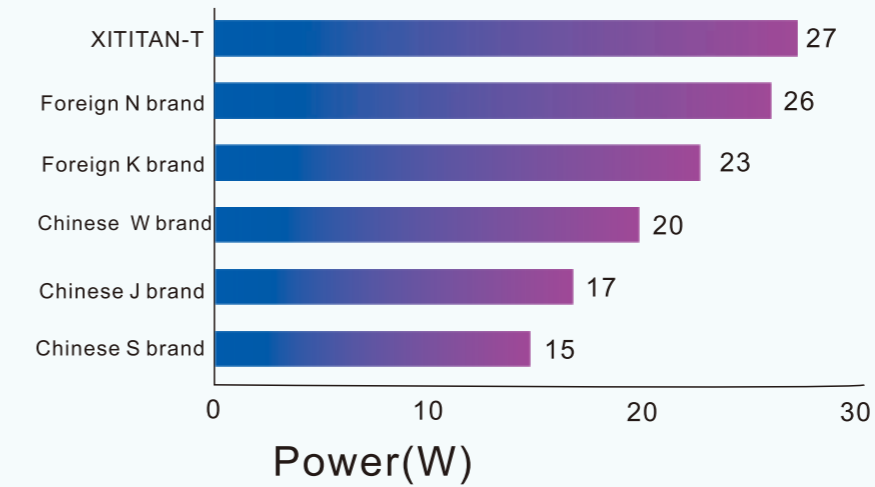

Mute, compare favorably with international high level products

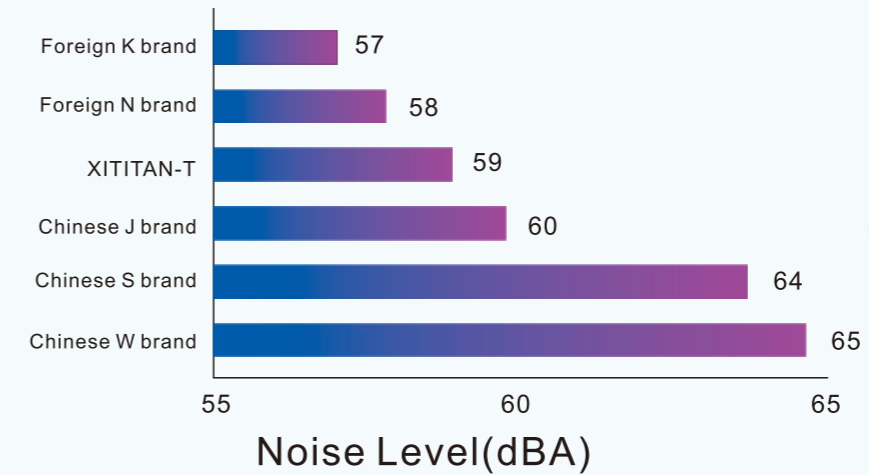

Compared with previous models
improvement in the efficiency 76.9%

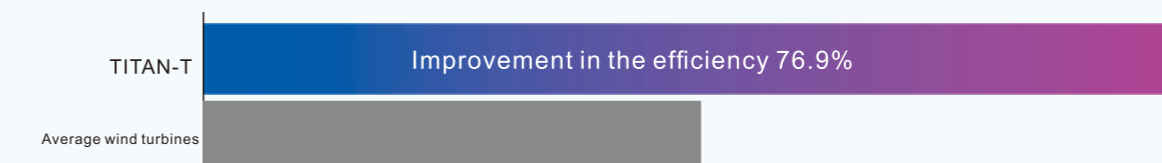

Handpiece Series

Professional Dental Handpiece Manufacturer

94
4 way spray
handpiece

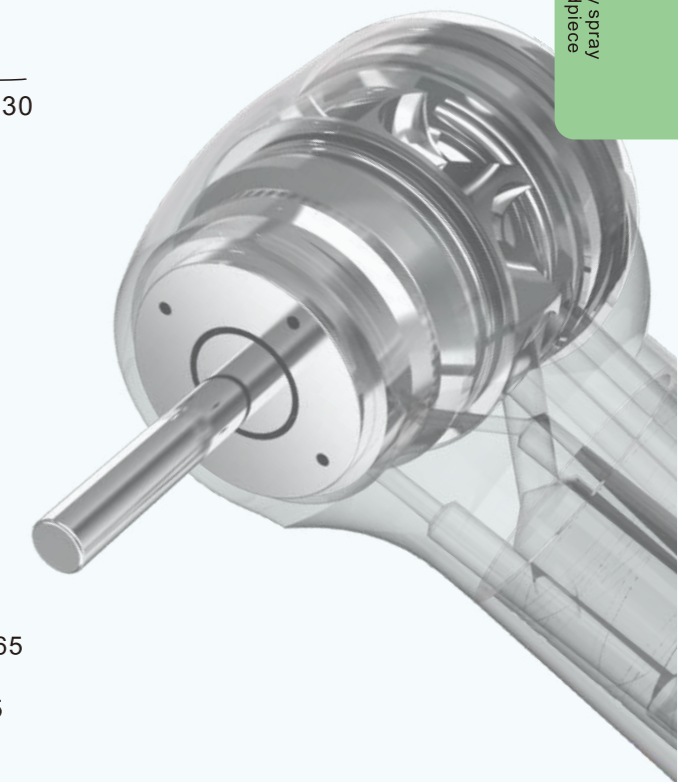

XTITAN SUPER TORQUE

- The cartidge according to Germany dynamic balancer to keep balance, lower noise
- Optimized torsion design, ensure provide stronger torque in long time

95
4 way spray
handpiece

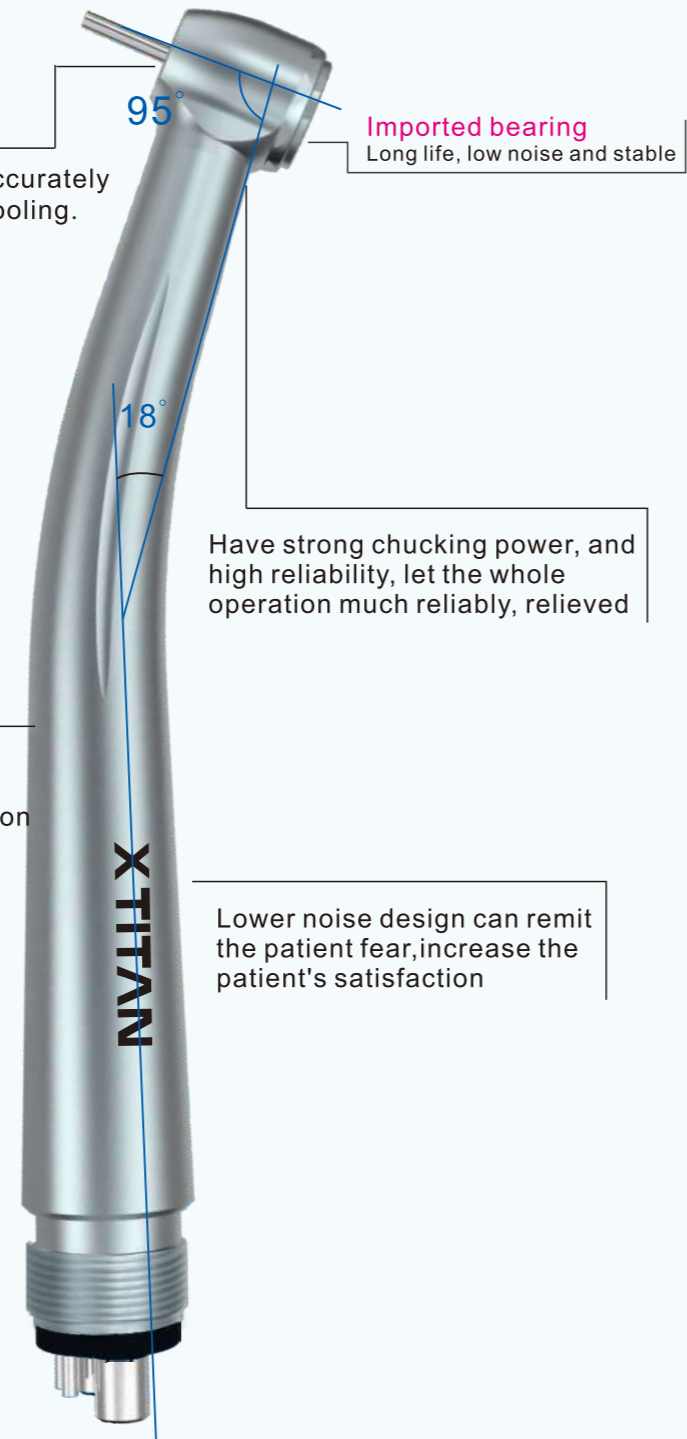

- Four-hole spray, unique spray angle, can accurately cover the tip of the bur, provides excellent cooling.

Imported bearing
Long life, low noise and stable

Have strong chucking power, and high reliability, let the whole operation much reliably, relieved

The TITAN body is designed to be ideal for 18 degrees and the head is 95 degrees. Provides the dentist with the best view, freedom of operation

Lower noise design can remit the patient fear, increase the patient's satisfaction



Order code: 210-B3-SP



Standard head Order code: H33-SP4
H33-SP2



Order code: 210-B3-TP

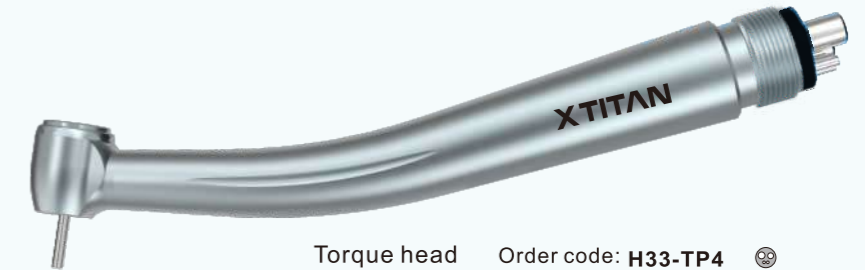

Torque head Order code: H33-TP4
H33-TP2

96
4 way spray
handpiece



Technical:

| | |
|-------------------------------------|--|
| The type of cooling | 4 way spray |
| Chuck type: | push button |
| Noise | ≤60dB |
| Air pressure at the back end of HP: | 0.25-0.28 MPA(4hole) 0.20-0.22 MPA(2hole) |
| Bur applicable: | Ø1.59-Ø1.6mmx21-23mm |
| Rotation speed: | ≥ 370,000rpm |
| The size of head | Ø12.5X14.8 (torque head) Ø11.5X14 (standard head) |

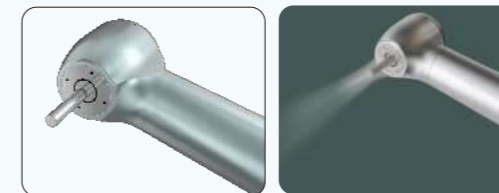

4 way spray. Good cooling system

LED HANDPIECE WITH GENERATOR

Model: CX207-F

New upgrade, new LED bulb, new integrated head



Self-luminous

Graceful body, simple, portable
easy clean, easy control

Balanced impeller
Cartridge passed the Germany dynamic balance machine test

Imported bearing
Long life, low noise and stable

Reject welding, complete head made by CNC, more stable!

97 LED handpiece with generator

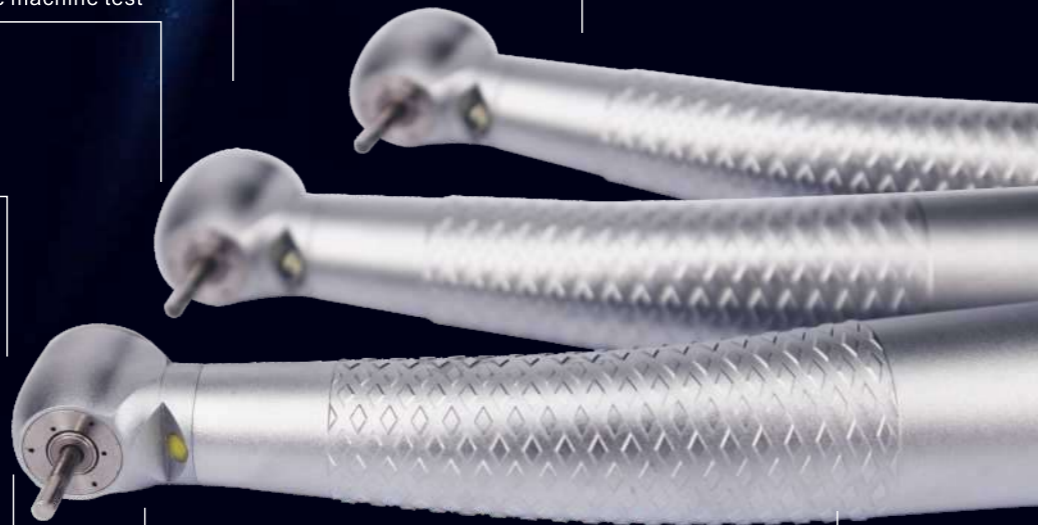

3 way spray, 3 air
Head and cartridge with anti-retraction structure

Professional LED light source,
superior brightness, Longevity 10000 hours.

Unique electric generator,
just a little air can generate sufficient power;

This product has been applied layout-design patent, counterfeit must be investigated.
NO. ZL201220717131.8 ZL201210563855.6

Technical:

| | |
|-------------------------------------|--|
| High speed handpiece: | 3 way spray 3 air |
| Chuck type: | push button |
| Bulb: | LED light |
| Noise | ≤70dB |
| Air pressure at the back end of HP: | 0.25-0.28 MPA(4hole) 0.20-0.22 MPA(2hole) |
| Bur applicable: | Ø1.59-Ø1.6mmx21-23mm |
| Rotation speed: | ≥ 300,000rpm |

Model: CX207-F

High-speed air turbine handpieces

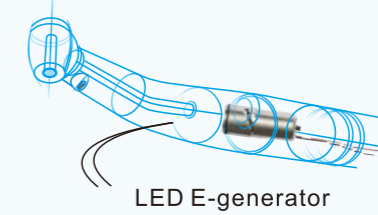
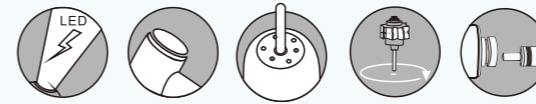

Order code: 210-F+-SP



Standard head

Order code: H15-SP4
H15-SP2



Order code: 210-F+-TP



Torque head

Order code: H15-TP4
H15-TP2



(Self-Luminous)

Mini head

Order code: H05-MP4
H05-MP2



Order code: 210-F-MP



Miniature head Quick coupling

Handpiece order code: H05-MPQ
Complete order code: H05-MPQ4
H05-MPQ2



Order code: 210-F+-SP



Standard head Quick coupling

Handpiece order code: H15-SPQ
Complete order code: H15-SPQ4
H15-SPQ2



Order code: 210-F+-TP



Torque head Quick coupling

Handpiece order code: H15-TPQ
Complete order code: H15-TPQ4
H15-TPQ2

98 LED handpiece with generator

LED HANDPIECE WITH GENERATOR

Model: CX207-F

Caries detection function

Self-luminous



Balanced impeller
Cartridge passed the Germany dynamic balance machine test

Reject welding, complete head made by CNC, more stable!

Imported bearing
Long life, low noise and stable

3 way spray, 3 air
Head and cartridge with anti-retraction structure

LED for caries detection
Treat while checking
Faster and better

Unique electric generator, just a little air can generate sufficient power;



This product has been applied layout-design patent, counterfeit must be investigated.
NO.ZL201220717131.8 ZL201210563855.6

Technical:

| | |
|-------------------------------------|--|
| High speed handpiece: | 3 way spray 3 air |
| Chuck type: | push button |
| Bulb: | LED light |
| Noise | ≤70dB |
| Air pressure at the back end of HP: | 0.25-0.28MPA(4hole) 0.20-0.22MPA(2hole) |
| Bur applicable: | Ø1.59-Ø1.6mmx21-23mm |
| Rotation speed: | ≥ 300,000rpm |

99 LED handpiece with generator

Model: CX207-F

High-speed air turbine handpieces

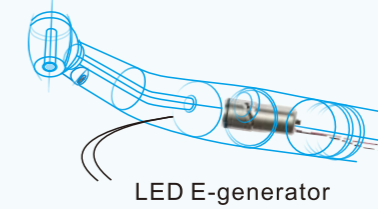
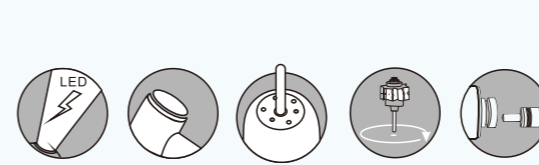

LED E-generator



Order code: 210-F+-SP



Standard head

Order code: H65-SP4
H65-SP2



Order code: 210-F+-TP



Torque head

Order code: H65-TP4
H65-TP2

100 LED handpiece with generator



Order code: 210-F+-SP



Standard head Quick coupling

Handpiece order code: H65-SPQ
Complete order code: H65-SPQ4
H65-SPQ2



Order code: 210-F+-TP



Torque head Quick coupling

Handpiece order code: H65-TPQ
Complete order code: H65-TPQ4
H65-TPQ2

OPTICAL HANDPIECE

Model: CX207-G

Optical fiber illumination

New upgrade, new integrated head

Fiber optic

Reject welding, complete head made by CNC, more stable!

Imported bearing
Long life, low noise and stable

Balanced impeller
Cartridge passed the Germany dynamic balance machine test

3 way spray, 3 air clean head system
Head and cartridge with anti-dust structure

Optical fiber illumination

Graceful body, simple, portable
easy clean, easy control

101

Optical handpiece

Technical:

| | |
|-----------------------|----------------------|
| High speed handpiece: | 3 way spray 3 air |
| Chuck type: | push button |
| Bulb: | LED light |
| Noise: | ≤70dB |
| Air pressure: | 0.25-0.28 MPA(6hole) |
| Bur applicable: | Ø1.59-Ø1.6mmx21-23mm |
| Rotation speed: | ≥ 300,000rpm |
| Bulb power: | 1w |
| Work voltage: | 2.9v-3.2v |
| Work current: | 160mA |

High-speed air turbine handpieces

Model: CX207-G



(Fit into **NSK**
Machlite/Phatelus*)

Standard head Handpiece Order code: **H16-NSPQ**
Complete order code: **H16-NSPQ6**

Torque head Handpiece Order code: **H16-NTPQ**
Complete order code: **H16-NTPQ6**



(Fit into **W&H**
Roto Quick*)

Standard head Handpiece Order code: **H16-WSPQ**
Complete order code: **H16-WSPQ6**

Torque head Handpiece Order code: **H16-WTPQ**
Complete order code: **H16-WTPQ6**



(Fit into **Sirona** R/F)

Standard head Handpiece Order code: **H16-SSPQ**
Complete order code: **H16-SSPQ6**

Torque head Handpiece Order code: **H16-STPQ**
Complete order code: **H16-STPQ6**



(Fit into **KaVo**
MULTifelix LUX)

Standard head Handpiece Order code: **H16-KSPQ**
Complete order code: **H16-KSPQ6**

Torque head Handpiece Order code: **H16-KTPQ**
Complete order code: **H16-KTPQ6**



Order code: **210-G+-TP**
For torque head



Order code: **210-G+-SP**
For standard head



Order code: **229-GN**
(Fit into **NSK**
Machlite/Phatelus*)



Order code: **229-GW**
(Fit into **W&H**
Roto Quick*)



Order code: **229-GS**
(Fit into **Sirona** R/F)



Order code: **229-GK**
(Fit into **KaVo**
MULTifelix LUX)

102

Optical handpiece

1 WAY SPRAY
HANDPIECE

Model: CX207-B/CX207-F

New upgrade, Mini Head
Wider vision

Mini



103
1 way spray
handpiece

Technical:

| | |
|----------------------------|-------------|
| High speed handpiece: | 1 way spray |
| Noise: | ≤68dB |
| Rotation speed: | 390-485Krpm |
| Water-flow rates: | > 50ml/min |
| Atomization gas flow rate: | ≥1.5L/min |
| Radial runout: | < 0.03mm |
| Clamping force: | > 22N |



Model: CX207-B/CX207-F

High-speed air turbine handpieces

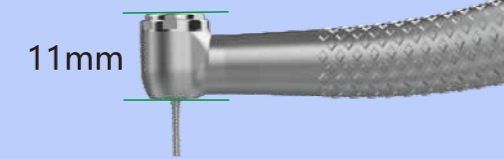
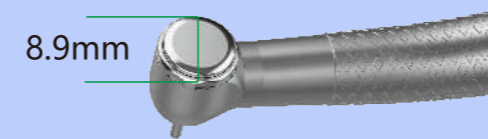

H03 MINI

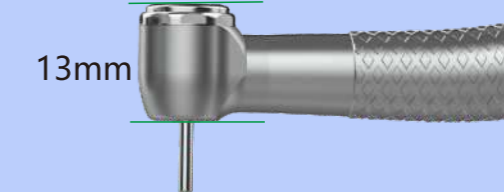
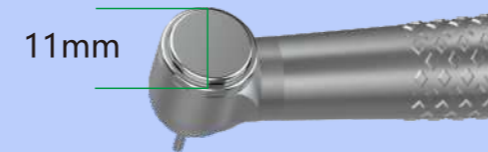

H13

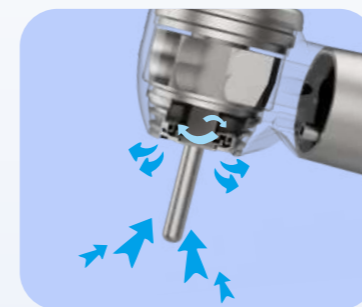

Dustproof structure
Cartridge passed the German
dynamic balance machine test

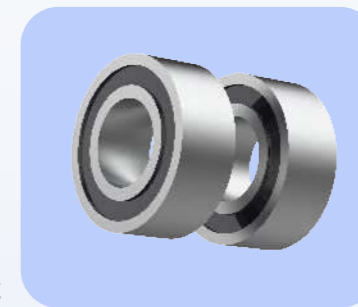

Imported bearing
long life, stable

104
1 way spray
handpiece

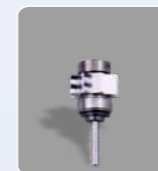

Order code: 210-B+-MP



Mini head

Order code: H03-MP4
H03-MP2

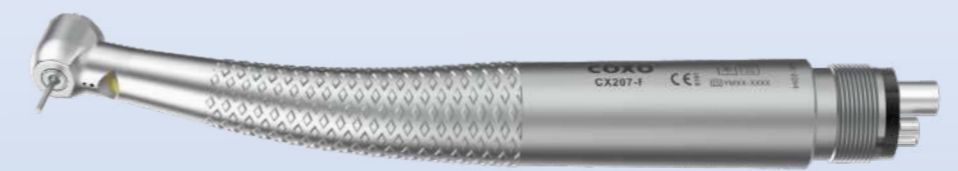

(Self-Luminous) Mini head

Order code: H05-MP4
H05-MP2

**1 WAY SPRAY
HANDPIECE**

Model: CX207-B

New upgrade, new integrated head



105
1 way spray
handpiece

Technical:

| | |
|-------------------------------------|--|
| High speed handpiece: | 1 way spray, 4 air spray |
| Chuck type: | push button |
| Noise | ≤68dB |
| Air pressure at the back end of HP: | 0.25-0.28 MPA(4hole) 0.20-0.22 MPA(2hole) |
| Bur applicable: | Ø1.59-Ø1.6mmx21-23mm |
| Rotation speed: | ≥ 300,000rpm |

Model: CX207-B

High-speed air turbine handpieces

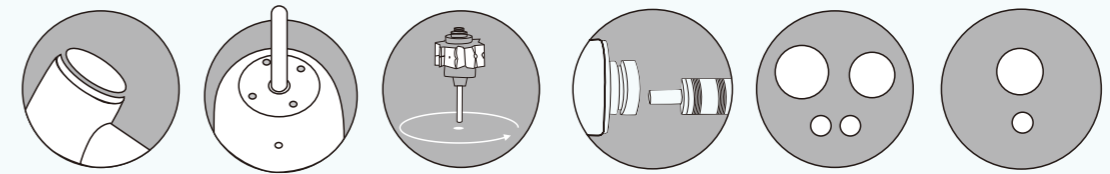

anti-dust structure

106
1 way spray
handpiece



Order code: 210-B+-SP



Standard head Order code: H13-SP4
H13-SP2



Order code: 210-B+-TP



Torque head Order code: H13-TP4
H13-TP2

**3 WAY SPRAY
HANDPIECE**

Model: CX207-W

New upgrade, new integrated head

Cartridge passed the Germany dynamic balance machine test

3 way spray, 3 air spray
Head and cartridge with anti-dust structure

Good cooling system,
soft push button

Wear-resisting, efficient operation

Graceful body, simple,
easy clean, easy control

107
3 way spray
handpiece



Technical:

| | |
|-------------------------------------|--|
| High speed handpiece: | 3 way spray, 3 air spray |
| Chuck type: | push button |
| Noise | ≤68dB |
| Air pressure at the back end of HP: | 0.25-0.28 MPA(4hole) 0.20-0.22 MPA(2hole) |
| Bur applicable: | Ø1.59-Ø1.6mmx21-23mm |
| Rotation speed: | ≥300,000rpm |

Model: CX207-W

High-speed air turbine handpieces

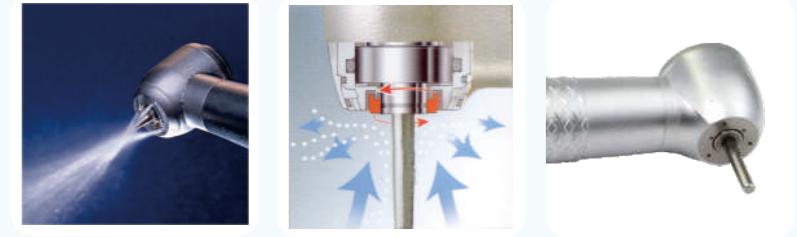
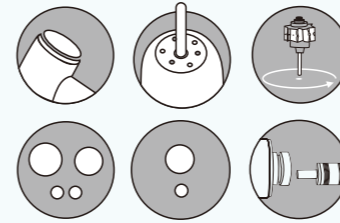

Order code: 210-W+SP



Standard head Order code: H17-SP4
H17-SP2



Order code: 210-W+TP



Torque head Order code: H17-TP4
H17-TP2



Order code: 210-W+SP



Standard head Quick coupling Order code: H17-SPQ4
H17-SPQ2

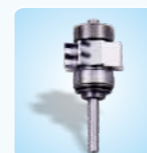

Order code: 210-W+TP



Torque head Quick coupling Order code: H17-TPQ4
H17-TPQ2

108
3 way spray
handpiece

COLOR
HANDPIECE

Model: CX207-C

New upgrade, new integrated head

Ceramic bearing
Cartridge passed the Germany
dynamic balance machine test

Wear-resisting, efficient operation

Good cooling system,
soft push button



Aluminum alloys body, light,
colorful, easy clean, easy control

Technical:

- High speed handpiece: 1 way spray, 4 air spray
- Chuck type: push button
- Noise: ≤68dB
- Air pressure at the back end of HP: 0.25-0.28 MPA(4hole)
0.20-0.22MPA(2hole)
- Bur applicable: Ø1.59-Ø1.6mmx21-23mm
- Rotation speed: ≥300,000rpm
- color: red yellow purple blue black

109
Color handpiece

Model: CX207-C

High-speed air turbine handpieces

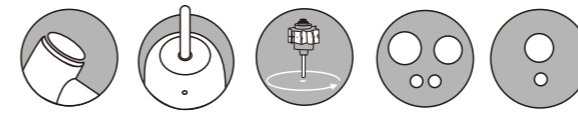

Standard head Order code: **H14-1SP4**
H14-1SP2
Red



Torque head Order code: **H14-1TP4**
H14-1TP2
Red



Standard head Order code: **H14-2SP4**
H14-2SP2
Yellow



Torque head Order code: **H14-2TP4**
H14-2TP2
Yellow



Standard head Order code: **H14-3SP4**
H14-3SP2
Purple



Torque head Order code: **H14-3TP4**
H14-3TP2
Purple



Standard head Order code: **H14-4SP4**
H14-4SP2
Blue



Torque head Order code: **H14-4TP4**
H14-4TP2
Blue



Standard head Order code: **H14-5SP4**
H14-5SP2
Black



Torque head Order code: **H14-5TP4**
H14-5TP2
Black



Order code: **210-C+-SP**
For standard head



Order code: **210-C+-TP**
For torque head

110
Color handpiece

Model: CX207-A

High-speed air turbine handpieces

New upgrade, new integrated head



Single way spray
more three air spray
Head and cartridge with
anti-dust structure



Cartridge passed the Germany
dynamic balance machine test

The special clean head designed
to avoid the entry of oral fluids and
other impurity into handpiece head.

Graceful body, simple,
easy clean, easy control



0.25-0.27MPA(4 hole)
0.20-0.22MPA(2 hole)



Order code: 210-A-SP



Standard head Order code: H02-SP4
H02-SP2



Order code: 210-A-TP



Torque head Order code: H02-TP4
H02-TP2

Model: CX207

High-speed air turbine handpieces

Technical:

| | |
|-------------------------------------|--|
| High speed handpiece: | 4 way spray |
| Chuck type: | push button/latch |
| Air pressure at the back end of HP: | 0.25-0.27MPA(4 hole) 0.20-0.22MPA(2 hole) |
| Bur applicable: | 1.6x25mm |
| Rotation speed: | 380,000-430,000rpm |



4 way spray

New water supply structure,
the cooling effect is better

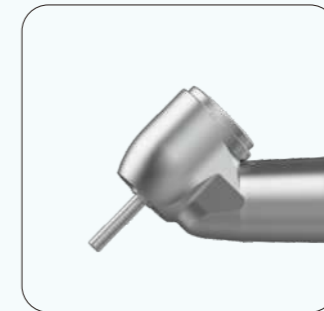

Windproof front

Add a dust cover to prevent
air leakage from the front end
and effectively prevent emphysema



210-D1-SP



45° Standard head Order code: H01-D2SP4
H01-D2SP2

111 Nature handpiece

112 Nature handpiece

OPTICAL HANDPIECE

Optical fiber illumination

Model: CX207-G

High-speed air turbine handpieces

Reject welding, complete head made by CNC, more stable!

Imported bearing
Long life, low noise and stable

Balanced impeller
Cartridge passed the Germany dynamic balance machine test

Optical fiber illumination



Order code: 210-GKD-SP



Order code: 229-GK1
fit into KaVo® MULTfelx® LUX

LED light fit into KaVo® MULTfelx® LUX



360° water adjustor

113 Optical handpiece

Standard head 45° Handpiece Order code: H06-KD1SPQ
Complete order code: H06-KD1SPQ6

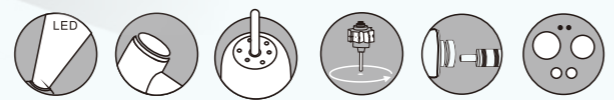

LED HANDPIECE WITH GENERATOR

Model: CX207-F

High-speed air turbine handpieces



Order code: 210-FD-SP



Standard head 45°

Order code: H05-DSP4
H05-DSP2

Model: CX207

High-speed air turbine handpieces

Reject welding, complete head made by CNC, more stable!

Imported bearing
Long life, low noise and stable



High speed handpiece 45 degree angle for impacted tooth.

Water cooling , no air come out from the head , avoiding hematoma during treatment

- High speed handpiece 45 degree angle for impacted tooth.
- Water cooling , no air come out from the head , avoiding hematoma during treatment
- Small trauma, short time, accurate force
- High torque, stable speed
- Minimally invasive extraction of impacted teeth is faster and safer

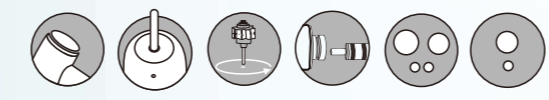

Technical:

| | |
|-------------------------------------|----------------------|
| High speed handpiece: | 1 way spray |
| Chuck type: | push button/latch |
| Noise | ≤68dB |
| Air pressure at the back end of HP: | 0.25-0.28 MPA(4hole) |
| | 0.20-0.22MPA(2hole) |
| Bur applicable: | Ø1.59-Ø1.6mmx21-23mm |
| Rotation speed: | ≥ 300,000rpm |



114 1 way spray handpiece



Order code: 210-D-SP



Standard head 45° Order code: H01-D1SP4
H01-D1SP2

**NATURE
HANDPIECE**

Model: CX207



115
Nature handpiece

Push button or wrench choose

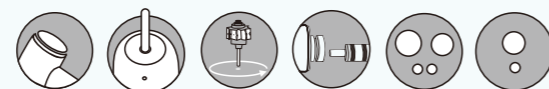

Technical:

| | |
|-------------------------------------|---|
| High speed handpiece: | 1 way spray |
| Chuck type: | push button/latch |
| Noise | ≤68dB |
| Air pressure at the back end of HP: | 0.25-0.28 MPA(4hole) 0.20-0.22MPA(2hole) |
| Bur applicable: | Ø1.59-Ø1.6mmx21-23mm |
| Rotation speed: | ≥ 300,000rpm |

Model: CX207

High-speed air turbine handpieces



Order code: 210-S



Order code: 210-SP



Order code: 210-TP



Standard head Order code: **H01-S4**
H01-S2



Standard head Order code: **H01-SP4**
H01-SP2

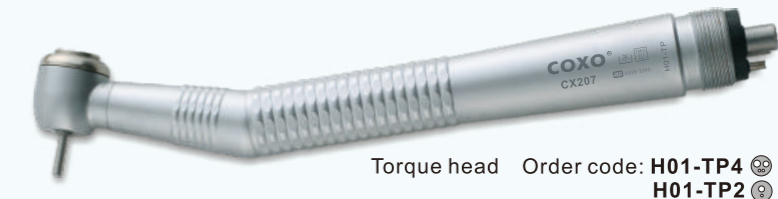

Torque head Order code: **H01-TP4**
H01-TP2

116
Nature handpiece

SPEED INCREASED

Model: CX235C7

CONTRA ANGLE

1:5 Speed increased Contra Angle

New upgrade, Better structure
Better performance



117
Speed increased
contra angle

1:5 speed increase

Technical:

| | |
|-----------------|------------------|
| Chuck type: | push button |
| Spray: | Inner channel |
| Bur applicable: | Ø1.6mm |
| Rotation speed: | about 200,000rpm |

Model: CX235C7

Geared Angle Handpieces



Order code: C7-5
Optic fiber



External water
Order code: C7-5S
Optic fiber



Order code: C7-6



V shape water spray structure
More stable and better cooling



More concentrated light
Increase the illumination
by 100%



Add sanitary hole
Reduce the risk of dirt
entering

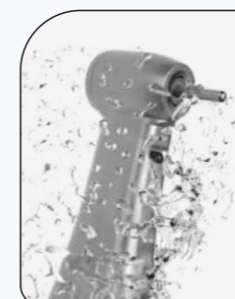

Improved shaft structure
Service life increased by
more than 90%

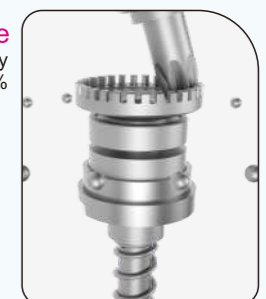

Better waterproof structure
To better prevent water from
entering the head

118
Speed increased
contra angle

SPEED INCREASED
CONTRA ANGLE

Model: CX235C7

1:5 Speed increased Contra Angle

New upgrade, smaller size
better handfeeling

Mini

110 Speed increased
contra angle



1.5 speed increase

Technical:

| | |
|-----------------|------------------|
| Chuck type: | push button |
| Spray: | Inner channel |
| Bur applicable: | Ø1.6mm |
| Rotation speed: | about 200,000rpm |

Model: CX235C7

Geared Angle Handpieces

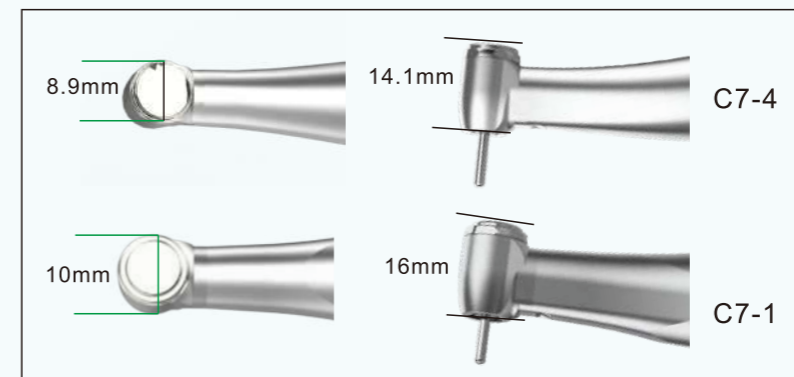

Reducing size and better angle

Improved handpiece and head angle, making it easier to reach the back teeth



120 Speed increased
contra angle



Smaller head with 92° angle

Larger elevation angle, making it easier to reach the back teeth

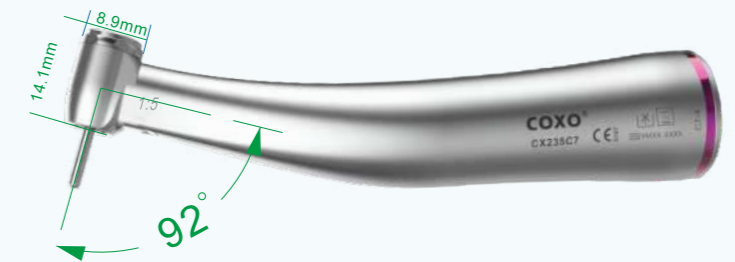

Order code: C7-4

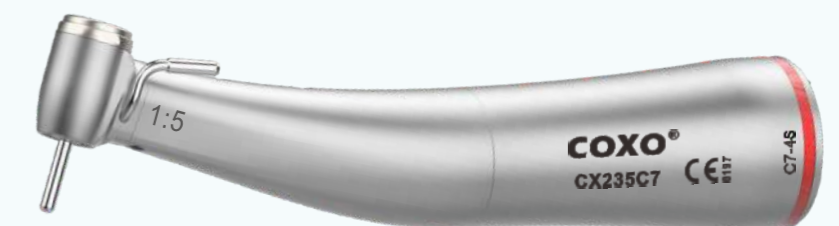

External water Order code: C7-4S

SPEED INCREASED
CONTRA ANGLE

Model: CX235C7

Geared Angle Handpieces

1:3.3 speed increase

Technical:

| | |
|-----------------|------------------|
| Chuck type: | push button |
| Spray: | Inner channel |
| Bur applicable: | Ø1.6mm |
| Rotation speed: | about 132,000rpm |



The nose has a 45° elevation angle, and the fuselage has an angle of 17°

SPEED INCREASED
CONTRA ANGLE

Model: CX235C7

Contra angle handpiece

1:4.2 speed increase

Technical:

| | |
|-----------------|------------------|
| Chuck type: | push button |
| Spray: | Inner channel |
| Bur applicable: | Ø1.6mm |
| Rotation speed: | about 168,000rpm |

4 hole water spraying
Spraying water to prevent subcutaneous emphysema during surgery
Effectively and quickly cool the needle.

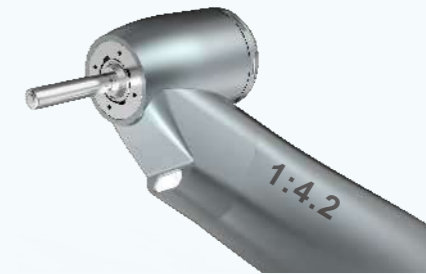

121 Speed increased contra angle



Equipped with a built-in self generating structure to drive LED lighting



Easy to disassemble

The nose is designed with anti water ingress

Cover anti scalding design

Detachable structural design for easy maintenance

Order code: C7-7
Optic fiber

Perfect accessibility of 45 degree angle fiber-optic handpiece provides the best adaptability and maximum performance for teeth
Easy access to the molar area
Minimize interference with front and adjacent teeth
45 degree inclined head for supine accessibility and maximum visibility

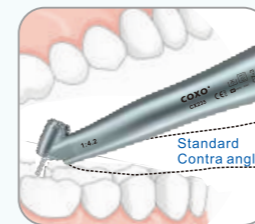

122 Speed increased contra angle

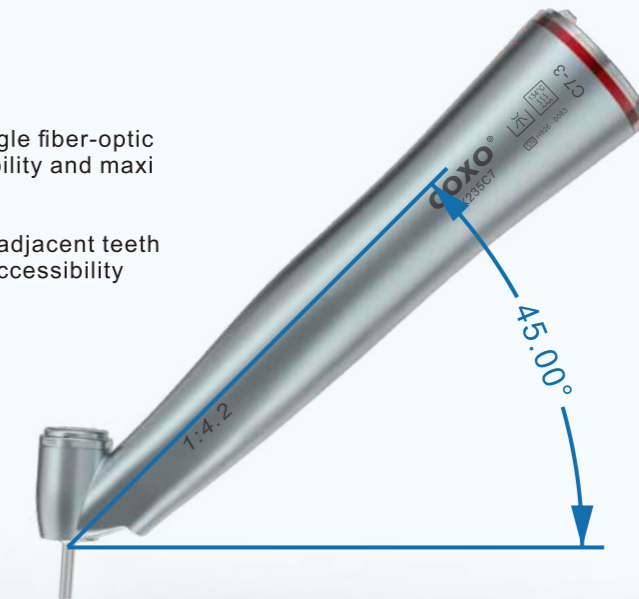

Order code: C7-3
Optic fiber



External water
Order code: C7-3S
Optic fiber

REDUCTION
CONTRA ANGLE

Model: CX235C6

Contra angle handpiece

20:1 Contra Angle for Implant

Easily disassembled, more reassuring treatment

123
Contra angle
handpiece



20:1 reduction

Technical:

Chuck type: push button
Spray: Inner channel and external
Bur applicable: $\varnothing 2.35_{-0.014}^{+0.014}$ mm (ISO1797-1)
Max speed: 2,000RPM
For implant
Internal cooling system: Kirschner / Meyer

Model: CX235C6

Geared Angle Handpieces



Easy to disassemble with tool

124
Contra angle
handpiece



Optic fiber Order code: C6-22



Order code: C6-23

**EXTERNAL
LOW SPEED HANDPIECE
SET**

Geared Angle Handpieces



External water spray,
Short motor,
Reducing size and weight
More comfortable to use

External Order code: **235-M SET-4** ☺



M-3F

Reducing size and weight
More comfortable to use



Technical:

| | |
|-----------------|---------------------------------------|
| Chuck type: | push button |
| Noise | ≤70dB |
| Air pressure: | 0.30MPa |
| Bur applicable: | Ø2.35 _{-0.014} mm(ISO1797-1) |
| Rotation speed: | about20,000rpm |

125 Dental low speed handpiece set

**EXTERNAL
LOW SPEED HANDPIECE
SET**

Geared Angle Handpieces



External Order code: **235-F SET-4** ☺
235-F SET-2 ☺



External Order code: **235-A SET-4** ☺
235-A SET-2 ☺

126 Dental low speed handpiece set

**INNER CHANNEL
LOW SPEED HANDPIECE
SET**

Geared Angle Handpieces



Optic fiber inner channel Order code: **235-C SET-6**



Optical fiber



6 hole



360 degrees of freedom rotary interfa

Technical:

| | |
|----------------------|---------------------------------------|
| Low speed handpiece: | 1 way spray |
| Chuck type: | push button |
| Noise | ≤70dB |
| Air pressure: | 0.30MPA |
| Bur applicable: | Ø2.35 _{-0.016} mm(ISO1797-1) |
| Rotation speed: | about20,000rpm |

**INNER CHANNEL
LOW SPEED HANDPIECE
SET**

Geared Angle Handpieces



inner channel Order code: **235-B SET-4**
235-B SET-2



Generator in contra angle



inner channel LED Order code: **235-E SET-4**
235-E SET-2

Technical:

| | |
|----------------------|---------------------------------------|
| Low speed handpiece: | 1 way spray |
| Chuck type: | push button |
| Noise | ≤70dB |
| Air pressure: | 0.30MPA |
| Bur applicable: | Ø2.35 _{-0.016} mm(ISO1797-1) |
| Rotation speed: | about20,000rpm |

REDUCTION
CONTRA ANGLE

4:1 Reduction

Low speed handpiece: 1:1 direct drive
 Chuck type: push button or wrench
 Spray: external
 Bur applicable: $\varnothing 2.35_{\pm 0.016}$ mm
 Rotation speed: MAX 10,000 rpm



4:1 Order code: **CB-3**



Order code: **CH-11**



Up and down movement



Order code: **C3-11**

6:1 Reduction

Low speed handpiece: 6:1 Reduction
 Chuck type: push button
 Max speed: 1200 rpm
 Max torque: 5.2 N.cm



Order code: **C5-1M**

10:1 Reduction

Low speed handpiece: 10:1 Reduction
 Chuck type: push button
 Spray: external
 Bur applicable: engine use file/hand use file
 Rotation speed: MAX 4,000 rpm
 Rotation style: 90° reciprocating rotate head

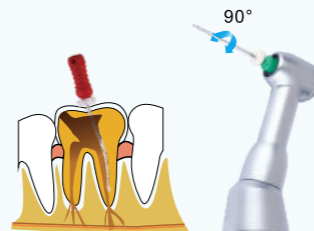

Fit to hand use files



10:1 Order code: **CB-5**



Order code: **CH-12**



hand use files



Order code: **C5-12**

Geared Angle Handpieces

REDUCTION
CONTRA ANGLE

64:1 Reduction

Low speed handpiece: 64:1 Reduction
 Chuck type: push button or wrench
 Spray: external
 Bur applicable: $\varnothing 2.35_{\pm 0.016}$ mm
 Rotation speed: MAX 625 rpm



64:1 Order code: **CB-8**



Order code: **CH-4**



Order code: **C8-4**

1:1 DIRECT DRIVE
CONTRA ANGLE

1:1 Direct drive

Low speed handpiece: 1:1 direct drive
 Chuck type: push button or wrench
 Spray: external
 Bur applicable: $\varnothing 2.35_{\pm 0.016}$ mm
 Rotation speed: MAX 40,000 rpm



1:1 Order code: **CB-1**



Order code: **CH-2**



Order code: **C1-2**



Order code: **CH-4**



Order code: **C1-4**



1:1 Order code: **CB-7**



Order code: **CH-17**



Order code: **C1-F**

**1:1 DIRECT DRIVE
CONTRA ANGLE**

Geared Angle Handpieces

New upgrade, new integrated head

1:1 Direct drive

Low speed handpiece: 1:1 direct drive
 Chuck type: push button
 Spray: inner channel
 Bur applicable: $\varnothing 2.35_{-0.016}^{+0.016}$ mm
 Rotation speed: MAX40,000rpm



Model: **CX235-1C**
 Order code: **C-1C**
LED LIGHT



Model: **CX235-1E**
 Order code: **C-1E**
GENERATOR



Model: **CX235-1B**
 Order code: **C-1B**



Model: **CX235C1**
 Order code: **C-1-1**
 Rotation speed: about 20,000rpm

**INNER CHANNEL/EXTERNAL
STRAIGHT HANDPIECE**

Straight Handpieces

1:1 Direct drive

Low speed handpiece: 1:1 direct drive
 Spray: Inner channel or External
 Bur applicable: For surgical $\varnothing 2.35_{-0.016}^{+0.016}$ mm
 Rotation speed: MAX40,000rpm



Order code: **S-2S**
 surgical operation 20°
 straight head



Model: **CX235-2C**
 Order code: **S-2C**
Optic fiber



Model: **CX235-2B**
 Order code: **S-2B**



Model: **CX235-2B**
 Order code: **S-2BS**



Model: **CX235-2C**
 Order code: **S-2CS**
Optic fiber



Model: **CX235-2F**
 Order code: **S-2F**



Model: **CX235-2A**
 Order code: **S-2A**



Model: **CX235-2**
 Order code: **S-2**

131
 Contra angle
 handpieces
 Air motors

AIR MOTOR

Air Motors

Spray: Inner channel or External
 Hole type: 6 hole or 4 hole or 2 hole
 Rotation speed: 20,000rpm



INNER
 CHANNEL

Model: **CX235-3C**
 Order code: **M-3C**
Optic fiber



Model: **CX235-3B**
 Order code: **M-3B-4**
M-3B-2



EXTERNAL

Model: **CX235-3F**
 Order code: **M-3F-4**
M-3F-2



External

Model: **CX235-3F**
 Order code: **M-3M4**

INNER
 CHANNEL

EXTERNAL

132
 Straight handpiece



ECONOMICAL

Economical complete kit

COMPLETE KIT

1:1 Direct drive



Order code: **H01-1 KIT-SP4** 
H01-1 KIT-SP2 



STUDENT HANDPIECE KIT

- 1PCS Anti-retraction high speed standard push handpiece
- 1PCS contra angle
- 1PCS straight head
- 1PCS low speed air motor
- 1PCS push button cartridge <Free>



133 Economical complete kit





Order code: **H01-2 KIT-S4** 
H01-2 KIT-S2 

HANDPIECE KIT

- 2PCS high speed standard handpiece
- 1PCS contra angle
- 1PCS straight head
- 1PCS low speed air motor
- 1PCS standard cartridge <Free>





Order code: **H01-2 KIT-SP4** 
H01-2 KIT-SP2 

HANDPIECE KIT

- 2PCS standard push handpiece
- 1PCS contra angle
- 1PCS straight head
- 1PCS low speed air motor
- 1PCS push button cartridge <Free>



Order code: **H01-1 KIT-S4** 
H01-1 KIT-S2 

HANDPIECE KIT

- 1PCS high speed standard handpiece
- 1PCS contra angle
- 1PCS straight head
- 1PCS low speed air motor
- 1PCS standard cartridge <Free>



Handpiece Accessories
Manufacturing all kinds of spare parts for handpiece

HANDPIECE ACCESSORIES

Shaft of cartridge

| | ORDER CODE |
|---|------------|
|  For NSK For W&H For KaVo L:12.6mm (long) | 245-4-1 |
|  For NSK For W&H For KaVo L:11.8mm (short) | 245-4-2 |
|  For NSK L:13.5mm (long) | 245-2 |
|  For NSK L:12.5mm (short) | 245-3 |

Generator

| | ORDER CODE |
|---|------------|
|  | 245-52 |





HANDPIECE ACCESSORIES

Quick coupling of high speed handpiece

| | ORDER CODE |
|--|------------|
|  fit into NSK machlite/ phatelus® (LED/optic fiber/6 hole) | 229-GN |
|  fit into W&H Roto Quick® (optic fiber/6 hole) | 229-GW |
|  fit into Sirona R/F (LED/optic fiber/6 hole) | 229-GS |
|  fit into KaVo® MULTiflex® LUX (LED/optic fiber/6 hole) | 229-GK |
|  fit into KaVo® MULTiflex® LUX (LED/optic fiber/6 hole) | 229-GK1 |
|  for KaVo® (4 hole) | 229-GK2 |
|  for NSK (4 hole) | 229 |
|  for NSK (2 hole) | 229-1 |
|  (For H17-SPQ4, H17-TPQ4) (4 hole) | 229-b |
|  (For H17-SPQ2, H17-TPQ2) (2 hole) | 229-1b |
|  245-55 4 or 6 hole gasket | |
|  245-10 2 hole gasket | |







HANDPIECE ACCESSORIES

Bulb(LED light)

| | ORDER CODE |
|---|------------|
|  For NSK (for 229-GN) | 261-1 |
|  (for 229-GW) | 261-2 |
|  For Sirona (for 229-GS) | 261-6 |
|  For KaVo (for 229-GK) | 261-3 |









HANDPIECE ACCESSORIES

Cartidge of contra angle

| | ORDER CODE |
|--|------------|
|  (for C7-1, C7-2) push button | 235-53 |
|  (For C-1E, C-1C, C-1B, C1-4) push button | 235-13-3 |
|  for NSK | 235-9 |
|  (For C2-1, C1-2) | 235-12 |
|  (for C6-19) | 235-30 |
|  (for C6-22) | 235-55 |











HANDPIECE ACCESSORIES

Head cup of handpiece

| | ORDER CODE |
|--|--|
|  Standard back cap (wrench chuck) | 245-5 For H01-S |
|  Standard back cap (push chuck) | 245-7 For H01-SP |
|  Torque back cap (push chuck) | 245-8 For H01-TP |
|  Standard back cap (push chuck) | 245-37 For H13/14/15/16/17/23/25-SP For H15-8SP |
|  Torque back cap (push chuck) | 245-38 For H13/14/15/16/17/23/25-TP For H15-8TP |
|  Cover for contra angle cartridge | 245-17 For CH-1 |
|  Standard back cap (push chuck) | 245-57 For H02-SP |
|  Torque back cap (push chuck) | 245-58 For H02-TP |

HANDPIECE ACCESSORIES

Bearing of handpiece

| | ORDER CODE |
|---|------------|
|  For NSK For W&H For KaVo For Sirona Imported bearing (Ø6.35XØ3.175X2.38) | 245-18 |
|  For NSK For W&H For KaVo For Sirona (Ø6.35XØ3.175X2.38) Steel bearing | 245-11 |
|  For NSK For W&H For KaVo For Sirona (Ø6.35XØ3.175X2.38) Steel bearing with cover | 245-12 |
|  For NSK For W&H For KaVo For Sirona (Ø6.35XØ3.175X2.38) Ceramic bearing | 245-13 |
|  For W&H For KaVo (Ø6.35XØ3.175x2.38) Ceramic bearing with cover | 245-19 |
|  For W&H For KaVo (Ø6.35XØ3.175x2.78) Steel bearing | 245-23 |
|  For KaVo (Ø6.35XØ3.175XØ5.97 X2.38X1.0) Steel bearing with step | 245-20 |
|  For KaVo (Ø6.35XØ3.175XØ5.97 X2.78X1.0) Steel bearing with step | 245-22 |
|  For Bien air (Ø3.175XØ7.938XØ3.571) Steel bearing | 245-30 |
|  (Ø8XØ4X3) Steel bearing for straight head | 245-14 |
|  (Ø10XØ5X4) Steel bearing for straight head | 245-15 |
|  (Ø7XØ4x2) Steel bearing for push button contra angle | 245-24 |
|  (Ø8XØ5x2.5) for CX235-2C Steel bearing for straight head | 245-27 |
|  (Ø7.938XØ2.38x3.572) Steel bearing for contra angle or motor | 245-28 |
|  (Ø6XØ3x2) Steel bearing for contra angle | 245-29 |
|  (Ø6.5XØ4x1.3) Steel bearing for mini contra angle | 245-56 |

HANDPIECE ACCESSORIES

Head set of contra angle

| | ORDER CODE |
|--|------------|
|  for NSK (for CA burs $\phi 2.35$) Max.40,000RPM | CH-2 |
|  for NSK (for CA burs $\phi 2.35$) Max.40,000RPM | CH-4 |
|  for KaVo (for CA burs $\phi 2.35$) Max.40,000RPM | CH-18 |
|  for NSK Lock of contra angle | 245-49 |



























ORDER CODE

| | |
|--|--------|
|  for NSK (for CA burs $\phi 2.35$) Max.30,000RPM (MINI head) | CH-13 |
|  for NSK (for file burs) Max.4000RPM | CH-12 |
|  (for CA burs $\phi 2.35$) for Endodontic treatment | CH-17M |
|  (for CA burs $\phi 2.35$) for Endodontic treatment | C1-17M |



HANDPIECE ACCESSORIES

Cartridge

| | | | |
|---|---|---|---|
|  |  |  |  |
| Order code: 210-B3-SP For H33-SP | Order code: 210-G+-TP For H16-NTPQ/H16-WTPQ H16-STPQ/H16-KTPQ | Order code: 210-W+-SP For H17-SP/H17-SPQ | Order code: 210-TP For H01-TP |
|  |  |  |  |
| Order code: 210-B3-TP For H33-TP | Order code: 210-G+-SP For H16-NSPQ/H16-WSPQ H16-SSPQ/H16-KSQP | Order code: 210-W+-TP For H17-TP/H17-TPQ | Order code: 210-S For H01-S |
|  |  |  |  |
| Order code: 210-F+-SP H15-SP | Order code: 210-B+-S For H13-S | Order code: 210-C+-SP For H14-SP | Order code: 210-SP For H01-SP |
|  |  |  |  |
| Order code: 210-F+-TP H15-TP | Order code: 210-B+-T For H13-T | Order code: 210-C+-TP For H14-TP | Order code: 210-FD-SP For H05-DSP |
|  |  |  |  |
| Order code: 210-F-MP H05-MPQ | Order code: 210-B+-SP For H13-SP | Order code: 210-A-SP For H02-SP | Order code: 210-GKD-SP For H06-KD1SPQ |
|  |  |  |  |
| Order code: 210-F+-SP H05-SPQ | Order code: 210-B+-TP For H13-TP | Order code: 210-A-TP For H02-TP | Order code: 210-D-SP For H01-D1SP |
|  |  | | |
| Order code: 210-F+-TP For H05-TPQ | Order code: 210-1-SP For H11-SP | | |

HANDPIECE ACCESSORIES

Shaft of contra angle

| | ORDER CODE |
|---|------------|
|  (for C6-19) | 235-25 |
|  (for C5-12/C5-12M) | 235-28 |
|  for NSK (for C1-2/C2-3) | 235-8 |
|  (for C1-4/C2-3) push button | 235-19 |
|  (for C-1C/C-1E) (for C-1B) | 235-23 |
|  (for C-1F) | 235-24 |
|  (for C6-22/C6-23) | 235-56 |

Gear of shaft

| | |
|--|---------|
|  for NSK | 235-8-1 |
|--|---------|

Accessories of Handpiece

ORDER CODE

| | |
|---|--------|
|  | 254-2 |
|  | 254-3 |
|  | 211 |
|  For NSK | 245-16 |
|  For S-2S Tubing | 245-45 |
|  For C4-9/C6-9 Tubing | 245-46 |
|  For C6-19 Tubing | 245-48 |

CUSTOM PRODUCT

HANDPIECE

MOQ:500PCS

▼ 3 way spray 3 air spray handpiece

- A1-SP Stan push head
- A1-TP Max push head
- A1-45SP Stan push head 45°

▼ Clean head system handpiece

- A2-S Stan head
- A2-T Max head
- A2-SP Stan push head
- A2-TP Max push head

▼ Three way spray handpiece

- A3-SP Stan push head
- A3-TP Max push head

▼ LED handpiece with generator

- A4-SP Stan push head
- A4-TP Max push head
- A4-45SP Stan push head 45°

▼ Fiber optical handpiece

- A5-SP Stan push head
- A5-TP Max push head



B1 body and pattern



B2 body and pattern



B3 body and pattern



B4 body and pattern



B5 body and pattern



C1 Coupling



C2 Quick coupling(for NSK)



C3 Quick coupling(for Sinol)



C4 Quick coupling of fiber optical (for NSK)

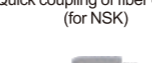

C5 Quick coupling of fiber optical (for W&H)

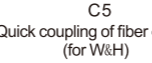

C6 Quick coupling of fiber optical (for Sirona)

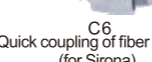

C7 Quick coupling of fiber optical (for KaVo)

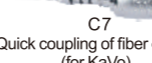

C8 Quick coupling (for KaVo)



2 hole



4 hole



6 hole

COXO could Provide OEM,ODM service,and COXO have some handpiece style and pattern provide customers choice, Choose as shown in figure:



Dental Operating Lights

Professional dental products manufacturer



order name: **CX249-24**

Feature:

- 1-There are 4 color can adjust temperature, from 4000 to 6000K
- 2-There are 12 high-power LED lights with adjustable illumination and the maximum illumination can reach 100000lux
- 3-Use LED lamp bead with 90 ORL to restore color authenticity
- 4-Conclude touch key and dual control switch with touch
- 5-Both sides have the same key panel, which is convenient for both hands to operate
- 6-Removable handle, alcohol sterilization or high temperature sterilization
- 7-The mirror panel can be easily observed by doctors or patients
- 8-The perfect for no shadow effect

Technical:

| | |
|-----------------------|------------------------|
| Power supply: | 24V |
| Power consumption: | 25W |
| LED light: | 12PCS |
| Light intensity(lux): | > 100000LUX |
| Dimension of pattern: | 80X160mm(in the 700mm) |
| Colour temperature: | 4000K~6000K |
| CRI: | >90Ra |
| Shadow(solution) | <Φ8mm |
| Eye intensty(lux): | <600lux |
| Interatcion range: | 20-80mm |
| Joint dimension: | ø22 |
| Weight(kg)/PCS | 2kg |



order name: **CX249-23**

Feature:

- 1-Free movement of 3axes,positioning the light to where you want.
- 2-Removable handles,easy to clean and easy to mount and dismount.
- 3-Optimized color of light,color temperature range from 5500-6500K,similar just like the natural light from your window.the power of light from 450-550 is limited to minimize the effect on the sensitive material use for the restoration,
- 4-Factory calibrated at 700mm(the average length of the human arm).a precise 80X160 rectangular light pattern with uniform intensity is produced.out side the light pattern there are 50% lower illustration level compare to specified requirement in ISO standard-illumination occurs only where you want it to in the oral cavity.not in the patient's eyes.

Technical:

| | |
|-----------------------|------------------------|
| Power supply: | AC12-24V |
| Power consumption: | 6-10W |
| LED light: | 6 PCS |
| Light intensity(lux): | >40000LUX |
| Dimension of pattern: | 80X160mm(in the 700mm) |
| Colour temperature: | 5000-5300k |
| CRI: | 85% |
| Shadow(solution) | <ø12mm |
| Eye intensty(lux): | <200lux |
| Interatcion range: | 20-80mm |
| Joint dimension: | ø22 |
| Weight(kg)/PCS | 1.6kg |



The mirror panel can be easily observed by doctors or patients

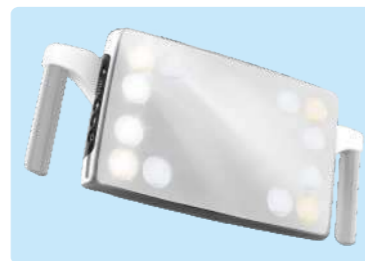

There are 12 high-power LED lights with adjustable illumination and the maximum illumination can reach 100000lux

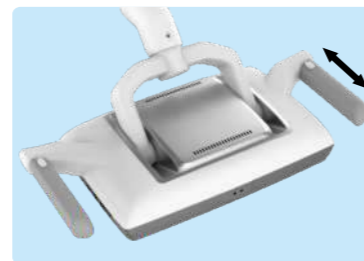

Removable handle, alcohol sterilization or high temperature sterilization



Both sides have the same key panel, which is convenient for both hands to operate



The beam spot is rectangular and the size is moderate. (80x160mm at 700mm) And no dazzle light around



6 high power LEDs Space for camera system reserved

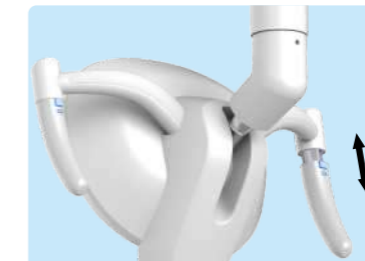

Removable handles,easy to clean.



Adjustable illumination (stepless), color temperature in the range of 5000K and 5300K.As a natural light, reduce damage to the eyes during long time operation.

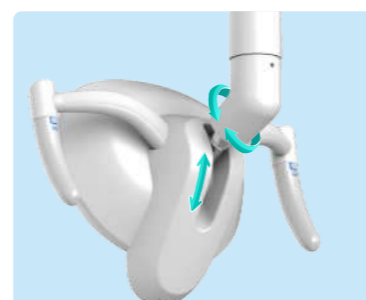

Free movement of 3 axes,positioning the light to where you want.



Double control system (sensor and switch)



The color and color temperature for the whole light spot are the same,greatly reduce the color separation through the lens,as well as the effectto the light sensitive material.

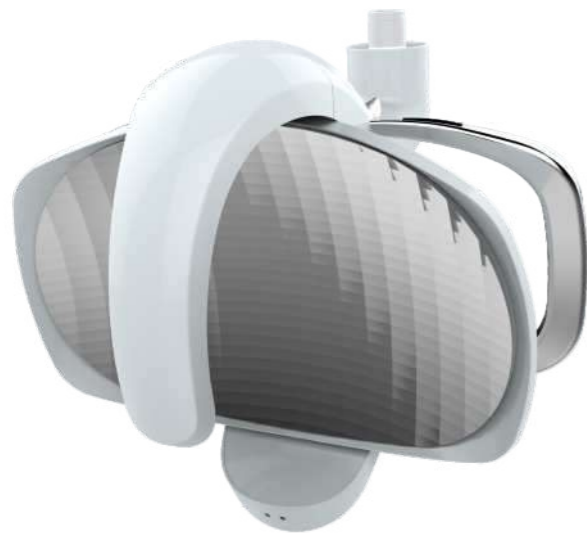

Feature:

- 1-Super-intense Illumination
- 2-Complete shadowless
- 3-Multi-angle adjustable
- 4-Life cycle of the LED can reach 17 years
- 5-Natural color Temperature

Technical:

| | |
|-----------------------|------------------------|
| Power supply: | AC12-24V |
| Power consumption: | 6W |
| LED light: | 1 PCS |
| Light intensity(lux): | >35000LUX |
| Dimension of pattern: | 80X160mm(in the 700mm) |
| Colour temperature: | 5000-6000k |
| CRI: | 85% |
| Shadow(solution) | <ø12mm |
| Eye intensity(lux): | <200lux |
| Interatcion range: | 20-80mm |
| Joint dimension: | ø22 |
| Weight(kg)/PCS | 1.75kg |

order name: **CX249-22**
Reflectance



Feature:

- 1-The light is soft, won't hurt your eyes, adpot CRI makes the shining face more realistic.
- 2-No color separation: the color and the color temperature for the whole light spot are the same, greatly reduce the color separation through the lens, as well as the effect to the lgiht sensitive material.
- 3-Light efficiency is higher: The illuminance can reach over 45000 lux when the power is 6W. The reflect mode can reach over 50000lx.
- 4-The LED dental lamp can reach stepless adjustable.

Technical:

| | |
|-----------------------|-------------------------|
| Power supply: | AC12-24V |
| Power consumption: | 6W |
| LED light: | 1 PCS |
| Light intensity(lux): | >30000LUX |
| Dimension of pattern: | 180×90 mm(in the 700mm) |
| Colour temperature: | 4000-6400K |
| CRI: | 85% |
| Shadow(solution) | <ø12mm |
| Eye intensity(lux): | <200lux |
| Interatcion range: | 20-80mm |
| Joint dimension: | ø22 |
| Weight(kg)/PCS | 1kg |

order name: **CX249-21**
Reflectance



Bionic Design, Patented Design

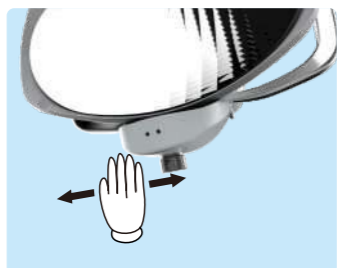

Almost 300 reflective palta, the projecting plane of them are more than Ø180. sensor range is 20mm-80mm



Gripping comfort and easy operation, removable cleaning

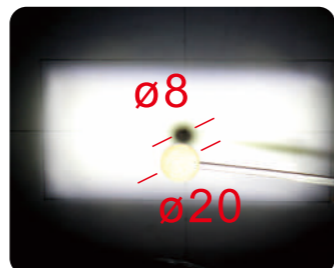

Shadowless effect is good. actual measure is Ø8.



The beam spot is rectangular and the size is moderate. (80x160mm at 700mm) And no dazzle light around

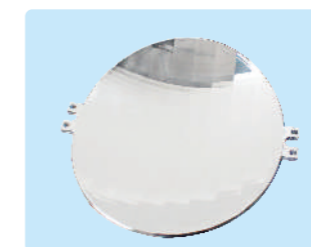

The reflector surface is composed of nearly 300 5x20 rectangular reflecting surfaces

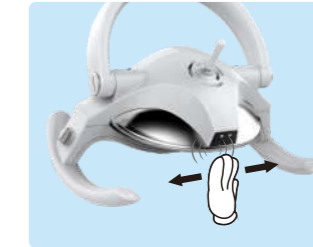

Moving near sensor points will be on or off light, the light during light on position, sensor range is 20mm-80mm



Holder shaft cap can be removed for easy maintenance; Knob handle next to the handle for disassembly purposes, Easy to handle clean.

CULTURE



VISITOR



Global dealer meeting



Global dealer meeting



THE FACTORY OPEN DAY



THE FACTORY OPEN DAY



2018guangxi



2018 Guangxi



2017Malaysia



2017zhongshan



2017huaxi



2017 myanmar



2016luoyang



2016huizhou



2015 Neimenggu



2014 Hongkong

The national tour of dental implant training



2018-12 shandong



2018-12 beijing



2017-11 fuzhou



2017-06 changsha



2017-11 guangxi



2017-11 chengdu



2017-8 guangxi



2016-12hunan

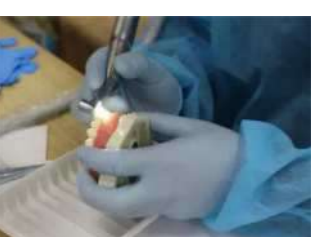

The national tour of dental implant training



2017-8 foshan



2018 -4shenzhen



2018-3 hubei



2017-7shandong



2017-7Shandong



2017-6 hubei



2017-6guangzhou



The national tour of minimally invasive repair training



2018-12 shandong



2018-12 beijing



2017-11 fuzhou



2017-06 changsha



2017-11 guangxi



2017-11 chengdu



2017-8 guangxi



2016-12hunan



COXO EXHIBITION SHOW



2023 Amic

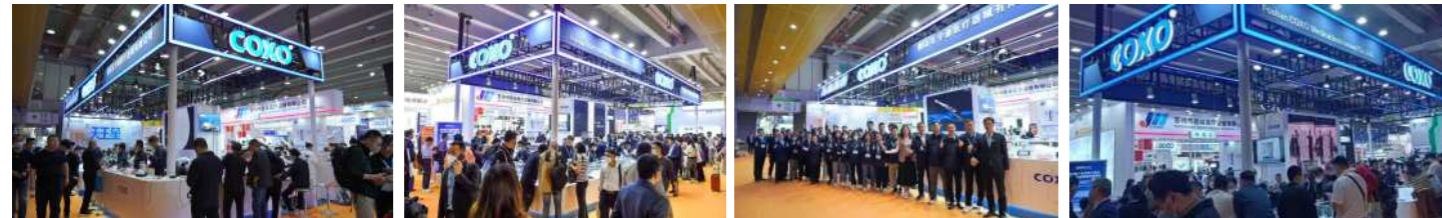

2023 Guanzhou



2023 Russia



2023 IDS



We know you want more than this even after you browsed all of the products in this book.

As the first professional manufacturer to supply the full series of components for dental chair unit, we are trying to make your China trip more comfortable and more simple, along this spirit, we make your one-stop purchasing dream be reality by our professional service and high-quality products with cheaper price. Today, our products have been sold to all over the world and our services have been extended to the whole world as well, and we have built up long term cooperation with a lot of manufacturers and distributors.

What we can do for you is:

one-stop purchasing service

Supply many kinds of products and components for you.

Introduce, recommend excellent dental chair manufacturers to you.

Offer you the services of inspection, loading, and logistic, etc.

And……all you need in China.

Thanks for your attention, let's hold hands and remain our cooperation forever!

Welcome to visit our factory or contact us any time.

Thanks for your attention and support!