



X-RADIUS TRIO PLUS
EVERY DIAGNOSTIC DIMENSION
DIRECT CONVERSION

X-RADIUS TRIO PLUS
EVERY DIAGNOSTIC DIMENSION
DIRECT CONVERSION

CASTELLINI.COM

<https://stomshop.pro>



BU Medical Equipment
Sede Legale Ed Amministrativa
Headquarters
CEFLA s.c. - Via Selice Provinciale, 23/a
40026 Imola (BO) - Italy
Tel. +39 0542 653111
Fax +39 0542 653344

Stabilimento
Plant
CEFLA s.c. - Via Bilocca, 14/C
40026 Imola (BO) - Italy
Tel. +39 0542 653441
Fax +39 0542 653601

Due to our policy of constant technological upgrading,
technical specifications may be subject to change without
prior notice. According to the standards in force, in extra-EU
areas the availability and specifications of some products
and/or characteristics may vary. Please contact your local
distributor for further information.

CASTELLINI.COM

03/2021 CXRTPGS181S01



PERFECT COMBINATION FOR ALL DIAGNOSTIC NEEDS

X-Radius Trio Plus represents the latest in 2D and 3D imaging technologies combined with ease of use across a vast range of applications. As a modular solution, the device enables countless upgrade opportunities and includes user-friendly software developed together with university specialists and radiologists.

Now available in the DC-ready version, dentists can opt for new-generation direct conversion technology both for PAN and CEPH sensors. Ensuring state-of-the-art clinical performance and superb image quality, X-Radius Trio Plus is also conceived to safeguard patient health by minimising radiation exposure in all possible ways.



CLINICAL EXCELLENCE

Providing a full range of 2D and 3D examination possibilities and supported by application-specific software functions to optimise diagnostic results, X-Radius Trio Plus is a hybrid system using CBCT technology for volumetric scans and high-performance filters ensuring the best clinical 2D radiography available today. As a modular platform, the initial configuration can be upgraded in several ways to cover all future needs of the surgery. X-Radius Trio Plus has been designed to facilitate such upgrades, optimising the investment and minimising the downtime for each upgrade.

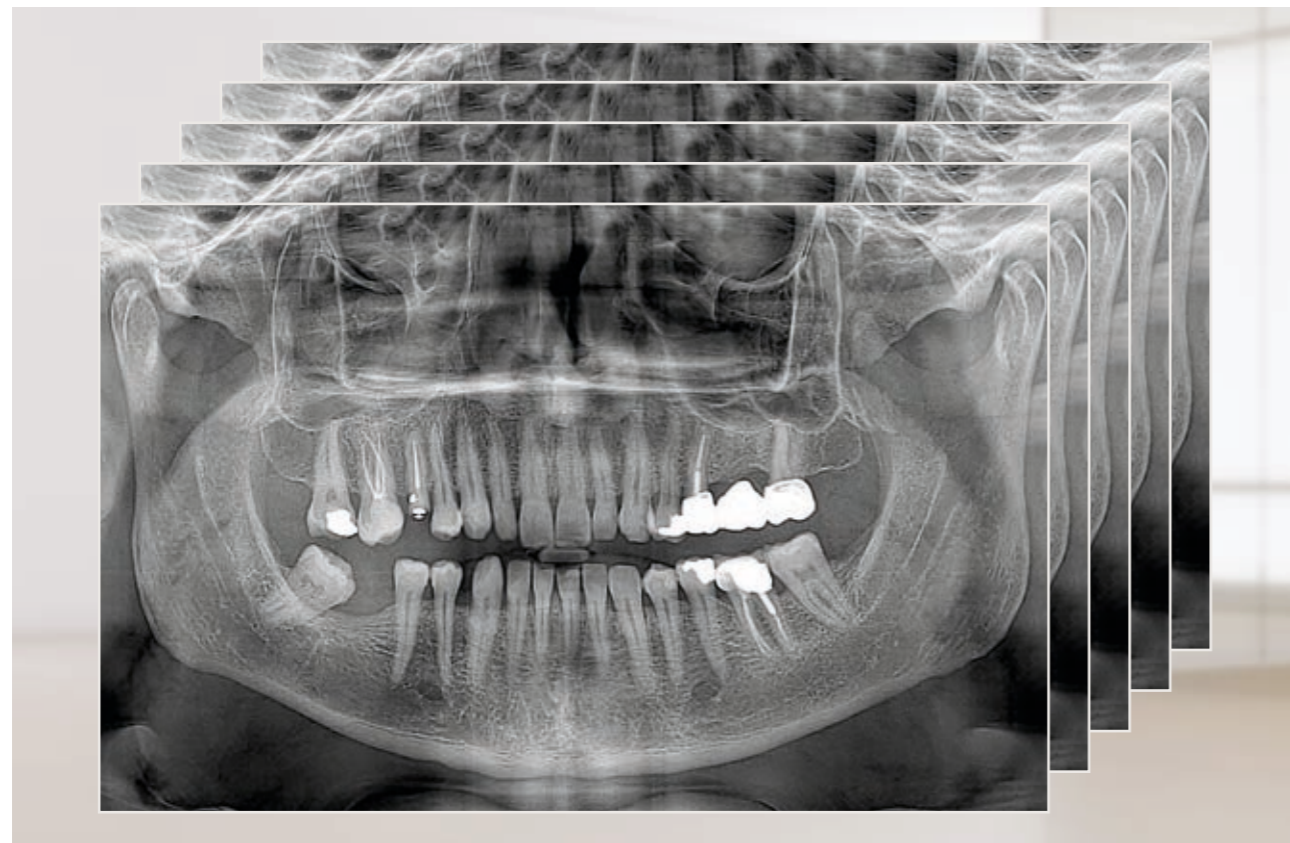

PREMIUM QUALITY PAN AND CEPH EXAMS

2D radiology is taken to new levels thanks to the highly sensitive CMOS Csl sensor, which can be switched from its initial position to complete the teleradiographic set-up for CEPH exams. Castellini's advanced hybrid radiographic platform includes protocols for adults and children. It is designed to cover all 2D diagnostic requirements, from standard dentition to panoramic images with excellent orthogonality, high-resolution bitewing images and views of temporomandibular joints and maxillary sinuses.



Highly detailed, precise images are achieved thanks to special filters. Panoramic X-rays are optimised through the use of PLUS image-enhancement filters ensuring critical detail of anatomical areas are improved, in particular the front roots. The MULTILAYER function provides a set of five images from a single scan allowing dentists to select the one best suited to their diagnostic needs.

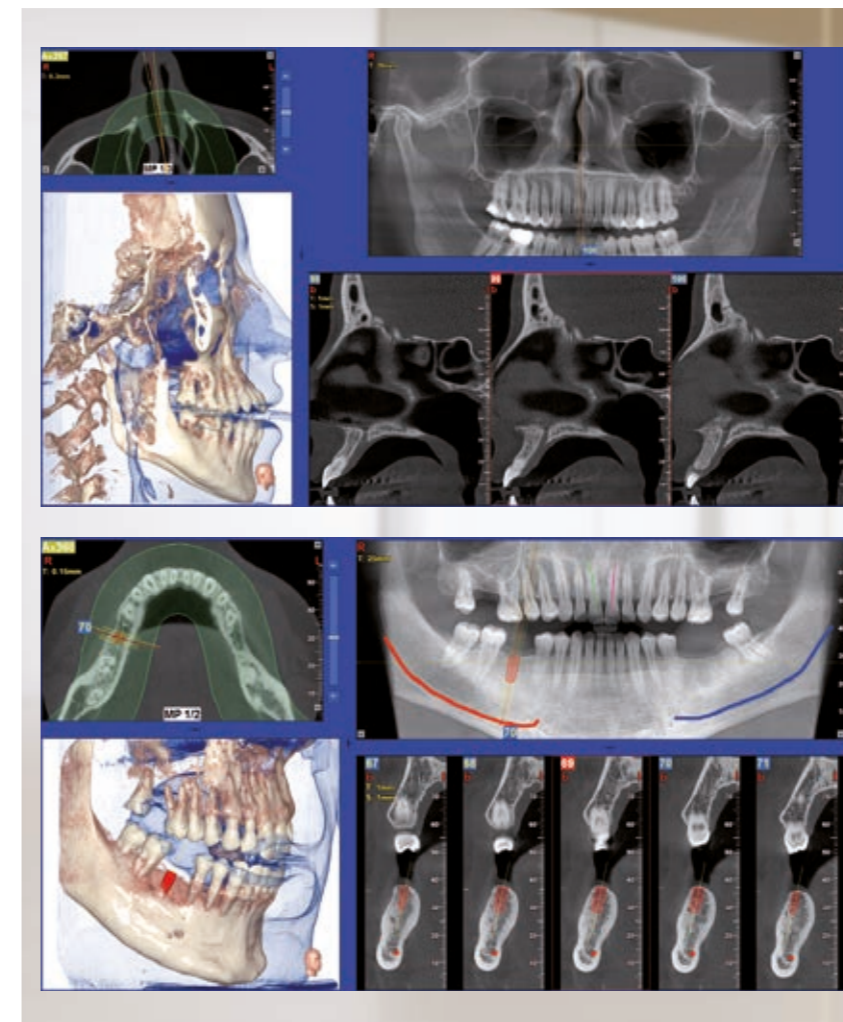

3D COMFORT

Complete dental applications and ENT requirements are adequately catered for in this advanced configuration. Large 3D volumes using a 13 x 16 cm FOV cover all aspects of dentition, maxillary sinuses and airways. Maximum precision is ensured and details regarding micro-fractures, bone height, root shape and tilt are highlighted.

3D EASY

With a 10 x 8 cm FOV, the standard configuration allows dentists to acquire volumetric data for both dental arches, including adult wisdom teeth, by means of a single scan. Perfect for implant assessments, endodontics and orthodontics, finely defined 3D volumes will provide valuable, comprehensive data for subsequent treatment.



iES - DC^{III} FOR PAN & CEPH

A powerful image Enhancement System (iES) automatically optimises image visualisation according to your preferred pre-established settings. The innovative direct conversion technology present in the 2D DC^{III} detectors significantly increases image definition and contrast while keeping the dose low.

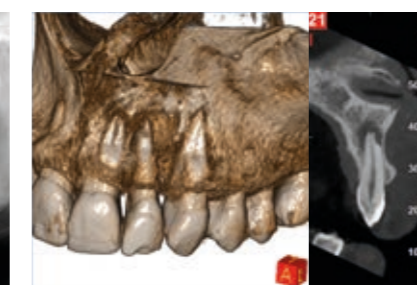

3D EXTREME FUNCTIONS

Superb image quality and considerable reduction of the radiated area is possible with the eXtreme Functions of the XF Pack. FOV 4 x 4 cm in low dose scans or ultra-high-resolution 68 µm provide exceptionally high quality diagnostic images to help especially in endodontics applications, revealing any secondary canals.

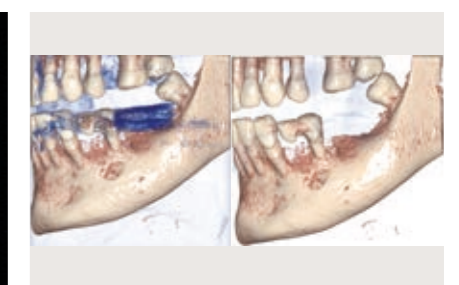

3D MAR FILTERS

Metal Artifact Reduction filters will significantly reduce artifacts caused by amalgam or implants that would otherwise compromise planning of specialist treatments requiring segmentation of anatomical structures.

ADVANCED FEATURES FOR COMPLETE 2D NEEDS



AUTOMATIC EXPOSURE CONTROL

Correct parameters are ensured thanks to patented exposure control mechanism built into X-Radius Trio Plus. Patient morphology is assessed prior to exposure, so that X-ray dosage is calibrated according to the actual physical characteristics and build of the person being examined. This results in suitable clinical images and avoids unnecessary exposure.

Enabling excellent orthogonality and constant magnification in all projections, the synchronised rotary and translatory movements together achieve high-quality diagnostic images by following the focal trough which closely adapts to the patient's anatomy.



Versatile and with a software suite designed to enable simple and immediate access to a host of 2D applications, X-Radius Trio Plus offers the broadest range of diagnostic protocols for adults and children. Each programme is refined to minimise exposure based on the actual needs. Complete panoramic images, upper or lower arch or simply with a choice of any one quadrant, high-resolution images of dentition and bitewing, as well as TMJ views and those of the maxillary sinuses are possible. Fractures, bone irregularities, unerupted teeth, braces, implants and prostheses can be examined in great detail.

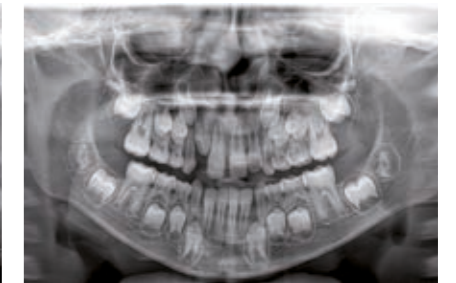
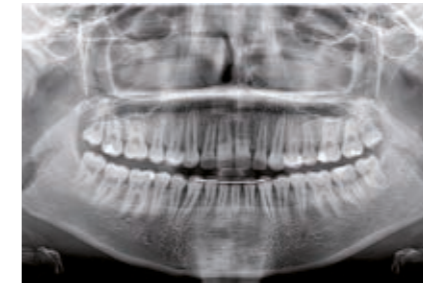

PERIODONTAL PROCEDURES (ORTHO PAN)

Panoramic X-ray with high-quality orthogonality and constant magnification with extremely low exposure times to perform complete analyses without compromise.

PAEDIATRIC DENTISTRY (CHILD PAN)

Complete analysis with limited exposure area and fast or partial scanning with minimum dose.

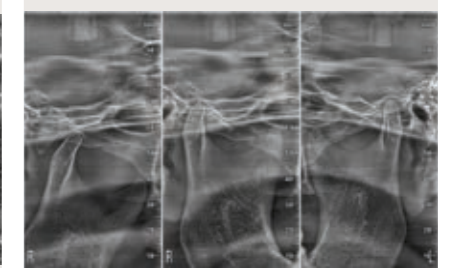
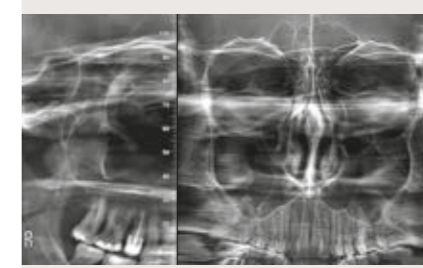

PARANASAL SINUSES (SIN)

Maxillary sinuses imaging with frontal and side views for pathology detection.

GNATHOLOGY (TMJ)

Examination of the temporomandibular joint with open and closed mouth, performed together as a single procedure, frontal and side views.

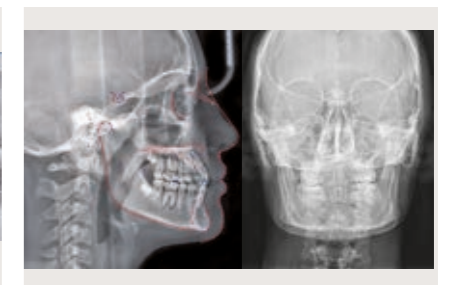

CONSERVATIVE DENTISTRY (DENT & BITEWING)

High-resolution examination of partial dentition with optimised interproximal view.

ORTHODONTICS (TELERADIOGRAPHY)

Analysis of complete frontal AP/PA or side views for cephalometric examinations, as well as automatic Ceph-X tracing.

2D DIRECT CONVERSION DETECTOR TECHNOLOGY

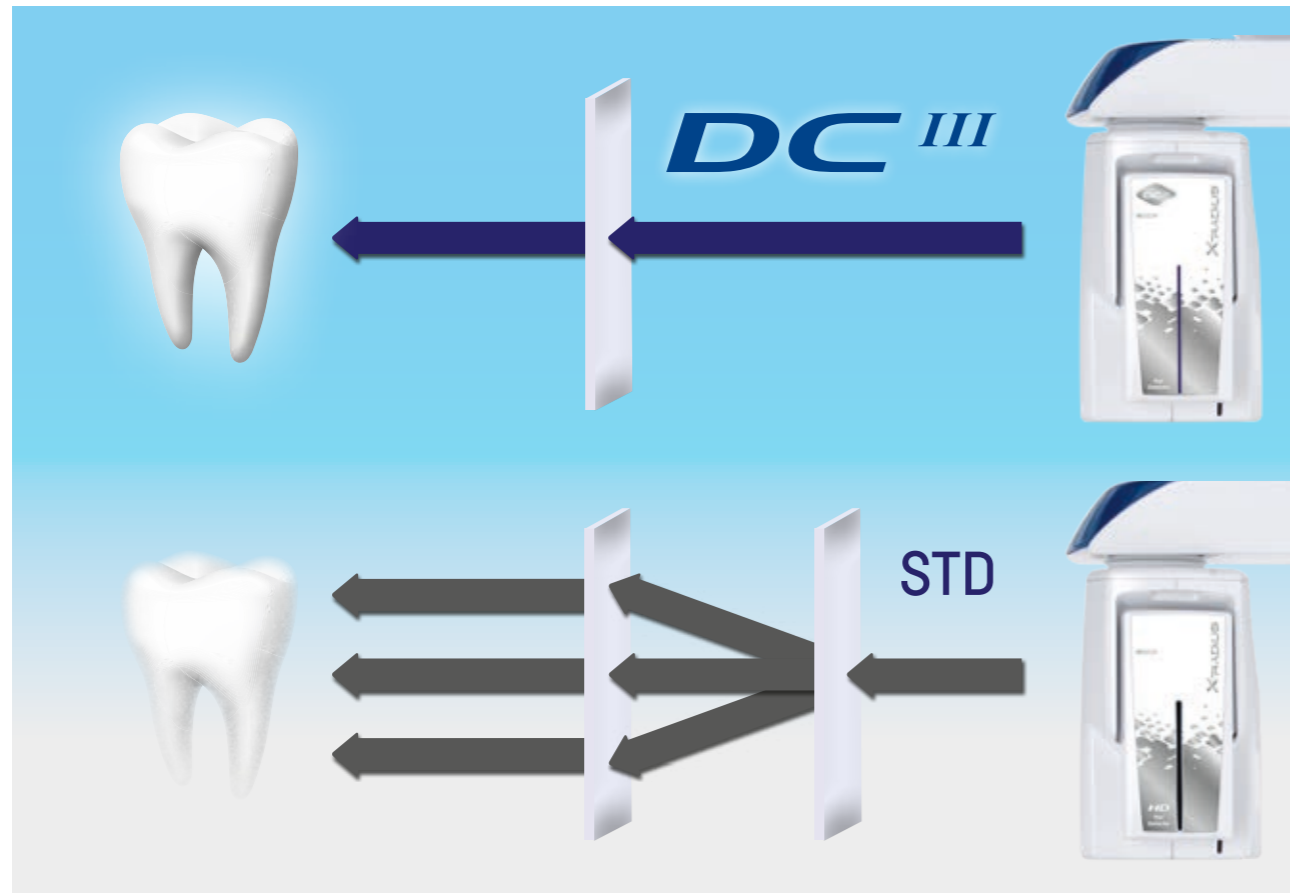

DIRECT CONVERSION DETECTOR (DCD)

Converted directly into electrical signals instead of transiting as pure light, X-ray photons remain intact until they form the panoramic image. This technology thereby generates significantly sharper images than those obtained using traditional technologies due to minimal scattering of the signal. High-contrast extra-oral 2D images at low doses are the result. This includes: panoramic images, teleradiographic, maxillary sinuses, TMJs, local dentition and extra-oral bitewing examinations, with zero compromise.

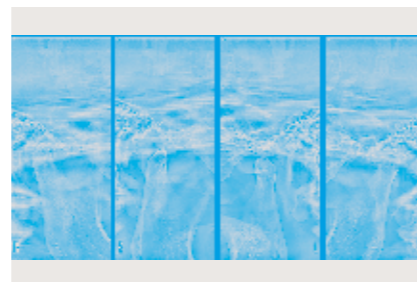

Opting for this latest-generation technology, dental surgeons and radiologists will be able to obtain the clearest 2D X-ray images for panoramic and cephalometric examinations. Moreover, direct conversion technology also allows for a potential reduction in dose despite obtaining better-defined images for more accurate diagnoses.

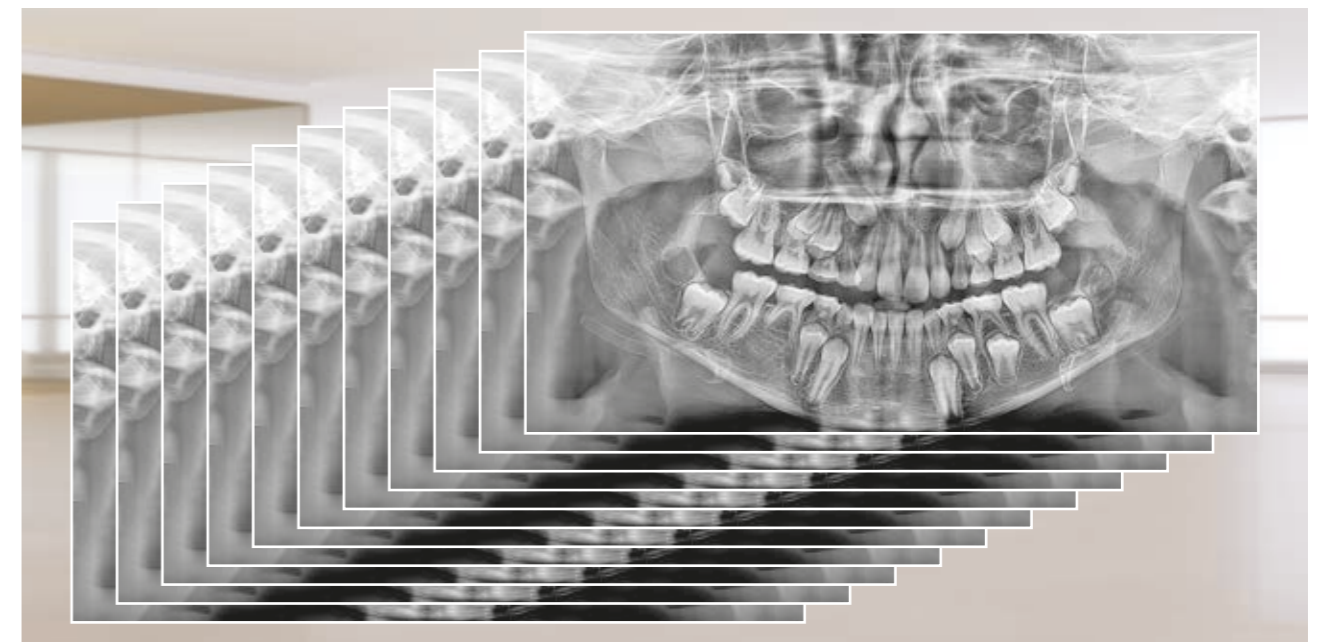

SUPREME MULTILEVEL PAN

Using direct conversion technology, the multilevel panoramic image benefits from greater depth of field, sharper focus and higher resolution. This allows for superior image quality maintaining the same dose in respect of patient health and safety. The high-efficiency Direct Conversion Detector, by improving the depth of field and increasing the resolution even at low doses, enables a broad data set from which an eleven-layer panoramic image can be obtained for complex morphology analyses.

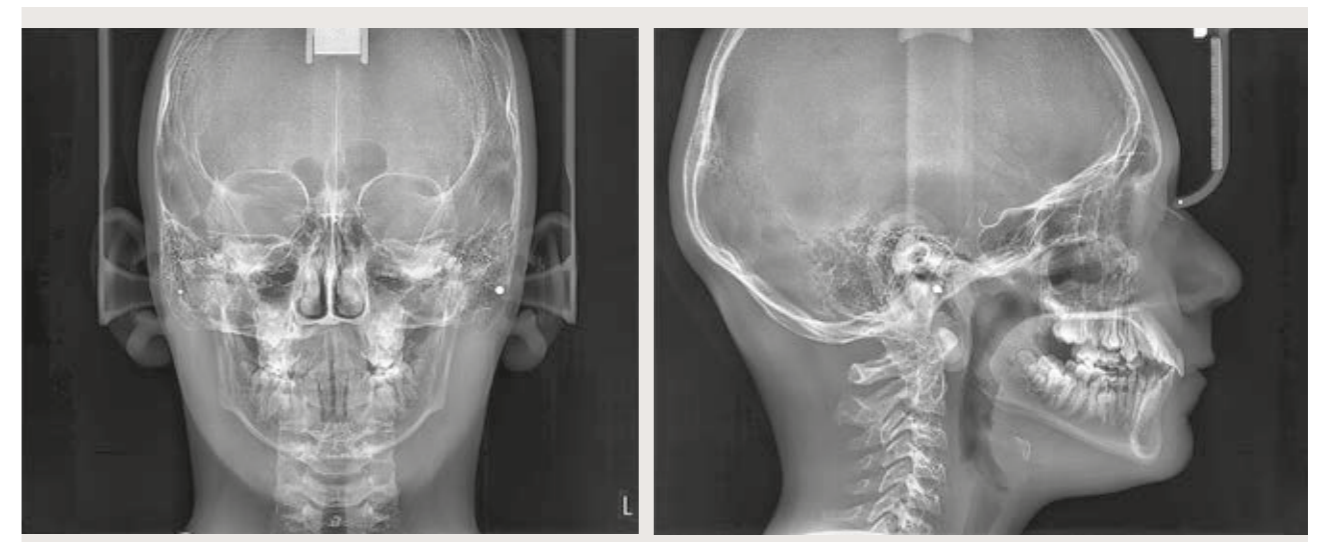

SUPREME CEPH

Antero-Posterior/Posterior-Anterior teleradiographic exams can now be accomplished in Speed Scan mode (just 4 s) with the Direct Conversion Detector, to reduce the dose. This technology also enables Supreme teleradiographic Latero-Lateral projections in Ultra HD for maximum resolution with new, faster scanning mode (just 7.5 s instead of 9 s) that exposes the patient to a lower dose.

ULTIMATE 3D DIAGNOSTIC POTENTIAL

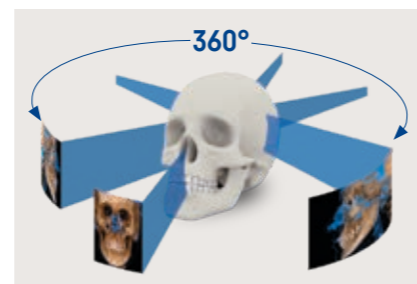
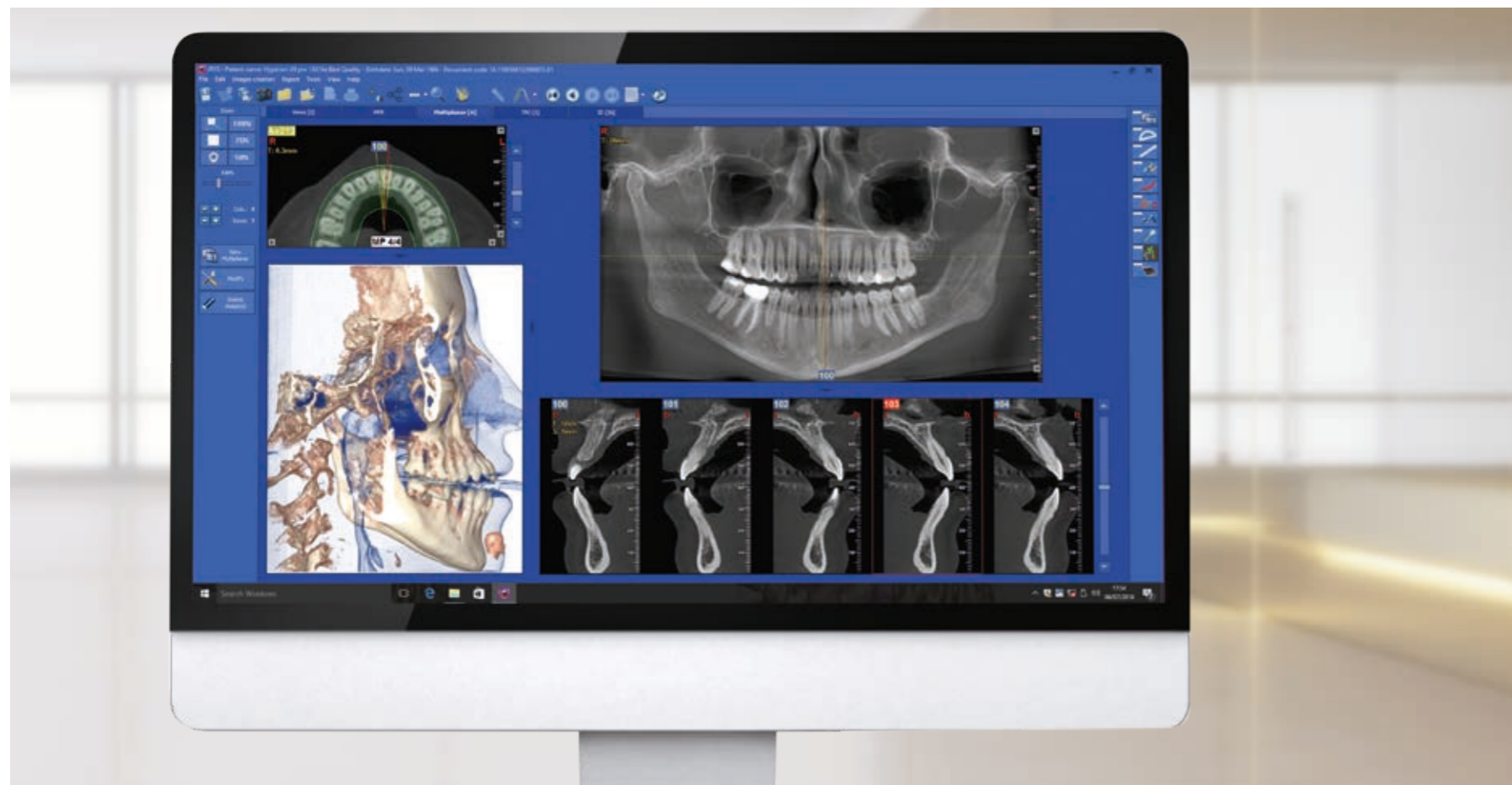

LATEST GENERATION SCANNING TECHNOLOGY

Built to cover the vast majority of volumetric scans, X-Radius Trio Plus can easily be upgraded to provide the best 3D diagnostic imaging data using a selection of standard FOV sizes which go from 6 x 6 cm to 13 x 8 cm. A 4 x 4 cm FOV is also available with the optional XF Pack. Supported by specific software programmes, dentists will obtain comprehensive clinical data for all dentistry applications such as implant planning simulation with volume and bone density evaluation and those for otorhinolaryngology with a dedicated software mode.

Integrated, fast 360° scanning technology together with pre-established algorithms consistently ensure excellent examination outcome. This acquisition method reduces artifacts and yields high-quality images.

Together with a wide choice of dynamic FOV dimensions and dedicated examination protocols, X-Radius Trio Plus ensures high-resolution volumetric images for diagnostic purposes. Thanks to specialist functions, it provides dental professionals with a new level of clinical workflow, enabling analyses of areas up to and including the zygomatic maxillary region and complete airways.

3D EASY

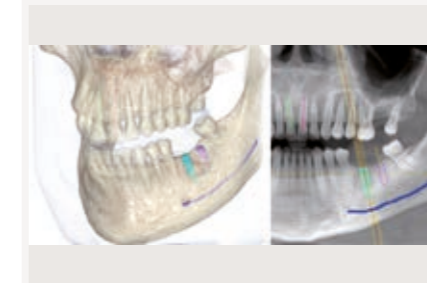

IMPLANTOLOGY PROJECT (FOV 10X8)

High-resolution (75 µm) analysis of the whole dentition on two dental arches to be used to plan implants, also in guided surgery.

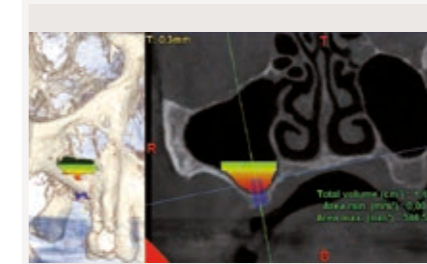

SINUS-LIFT SIMULATION (FOV 8X8)

Upper dental arch analysis, including the maxillary sinuses, to correctly plan a sinus lift for implant surgery.

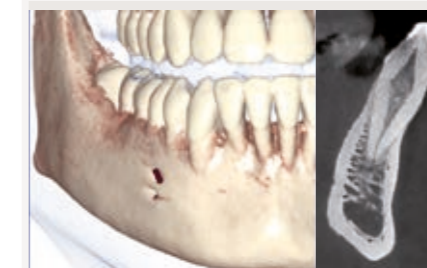

ENDODONTIC ANALYSIS (FOV 6X6)

Localised high-definition (75 µm) analysis with exposure limited only to the area of interest.

3D COMFORT

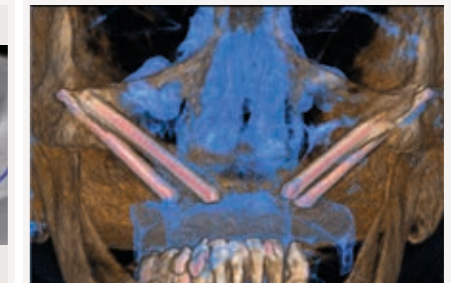

FOLLOW-UP OF ZYGOMATIC IMPLANTS (FOV 13X10)

Low-dose post-operative analysis of zygomatic implants to assess the current state of the patient's treatment.



ORTHODONTIC TREATMENT (FOV 10X10)

Analysis of the whole dentition, including the third molars, to provide a correct treatment assessment also with impacted or supernumerary teeth.

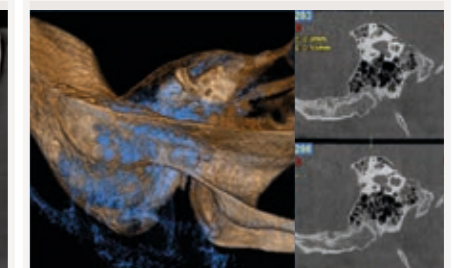

EAR ANALYSIS (FOV 7X6)

eXtreme Functions up to 68 µm resolution for better evaluation of small inner ear structures.

ETHICAL TECHNOLOGIES



While providing the greatest diagnostic accuracy thanks to unrivalled image quality, Castellini also ensures that aspects regarding patient health and safety are a constant priority. First of all, patient comfort is achieved with efficient positioning procedures and extremely short scan times, avoiding both physical discomfort and unnecessary exposure to radiation in respect of the ALARA principle. Accurate positioning conducted face-to-face, as well as SCOUT VIEWS also ensure first-time satisfactory images and no need to repeat acquisition. Low dosage, variable scan-specific collimation, pulsed emissions and high-speed scans all contribute to safeguarding patient health.

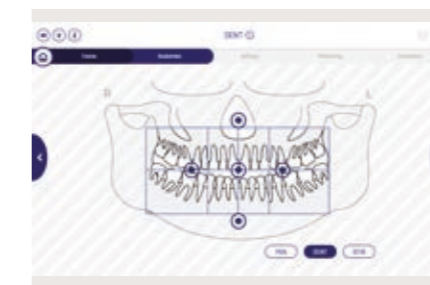

SIMPLE DENTITION

The exposure area can be adjusted according to the actual X-ray imaging needs for adults or children to include the whole or partial dentition, also dividing it into Bitewing quadrants or sectors.



SMART CEPH

Selection of the exposure area according to the real needs, thanks to the smart collimation system on the rotating arch, which optimises imaging without getting in the patient's way. Moreover, the DC^{III} Detector allows you to further reduce the CEPH scanning time.



DYNAMIC 3D FOV

The dynamic FOV selection makes it possible to limit the exposure only to the area of interest and perform dedicated analyses for various applications, both for adults and children.



HIGH-LEVEL CONTRAST DC^{III} TECHNOLOGY

Compared to standard sensors, the new Direct Conversion 2D Detector, available as an option for PAN and CEPH exams, enables significantly higher levels of contrast at the required resolution, thereby improving diagnostic capabilities at a defined dose.

SUPERIOR PRACTICALITY

Operators will appreciate a host of practical solutions that Castellini has integrated into X-Radius Trio Plus. Starting from the entirely modular concept which enables any configuration with countless upgrade opportunities optimising initial investment and leaving doors open to future professional growth. Available with one, two or three sensors, dentists can select the version best suited to their existing needs. Furthermore, selecting which 2D detector to adopt for PAN and CEPH – either standard with CsI scintillator or with the latest DC technology – will not affect retrofit availability of the new DC detector at a later stage.



ULTIMATE FLEXIBILITY

Dentists can initially opt for the basic PAN version, with or without the CEPH arm. PAN together with one of two 3D configurations, based on FOV dimensions, is possible as well as a 3-in-1 solution including PAN, CEPH and 3D. XF Pack as an optional upgrade provides additional functions for more specific 3D applications. Exposure parameters are selected automatically and workflow is simplified by a series of guided procedures.

A dedicated 2D (PAN/CEPH) detector (available either standard HD or latest-generation DC technology) and a wide 3D detector are fitted side-by-side. Once the examination protocol is selected on the console, the rotating sensor unit positions itself according to the sensor required. When not in use, this unit regains the position to make the equipment as compact as possible.



RELOCATABLE DETECTOR

Fitted with the teleradiographic arm, a second 2D detector is available, whereas the equipment is usually supplied with a single sensor which can be switched from

PAN to CEPH position. Manually released in all positions, switching the sensor can be performed quickly and safely.

KEYPAD

The control unit features a handy keypad incorporating the position reset button, up-down keys for column height and chin support adjustments and two keys to achieve TMJ centring or servo-assisted 2D (PAN/DENT), pre-scan focusing.

EFFICIENT WORKFLOW

Obtaining the correct diagnosis is key to any treatment, obtaining it with the support of technologies designed to facilitate the entire procedure is the best approach to combine efficiency with a prompt return on investment. Operators are guided at all times in selecting the best-suited investigation protocols. The touchscreen console is intuitive and lets users quickly identify the appropriate mode, speeding up workflow in the surgery.



TAKE CONTROL FOR OPTIMAL RESULTS

Dentists can select the virtual console of their choice; on-board as a 10" touchscreen panel with attractive graphics or on a PC or iPad. Dentists are free to use all three platforms simultaneously, obtaining 2D previews only on iPad and complete volumetric data via PC with the embedded Castellini software. The multiple platform console enables access to all device features and the guided procedure entails exam selection and FOV positioning. Favourites can be personalised to access the programmes most frequently used in the surgery.



Smart alignment for correct positioning prior to 3D scans and two Scout View images make sure no time is wasted in obtaining volumetric data exactly according to needs.

<p>LOW DOSE</p>	<p>REGULAR</p>	<p>BEST QUALITY</p>
------------------------	-----------------------	----------------------------

SPEED SCAN

Routine or post-surgical follow-up exams can be handled with low dosage scans, also suited to macro-structural analyses.

STANDARD SCAN

High-resolution 3D images obtained with standard scans are ideal for initial diagnosis and treatment planning.

ULTRA SCAN

Top-quality, ultra-high-resolution scan mode for the most detailed, comprehensive volumetric data, especially for microstructures.

PERFECT PATIENT POSITIONING

Relaxed patients will always improve efficiency and workflow, so Castellini provides dentists with every means to involve patients in a smooth procedure, which leads to less time immobilised during the examination. The greater the degree of collaboration obtained, the better the results of the diagnosis and subsequently the treatment outcome.



ACCURACY STARTS WITH THE RIGHT POSITION

Patients are made to feel at ease with a face-to-face procedure during pre-scan set-up. Guided by an effective alignment system with 4 laser beams, patient positioning is both fast and precise, and an ergonomic head support using 7 stabilising points ensures the correct position is maintained throughout the scan procedure.

Precise instructions are provided on the on-board control panel to make the procedure easier and faster, matching positioning to the selected protocol.



COMPLETE CEPH CAPABILITY

Available with left-hand or right-hand side configuration, the CEPH unit is fitted with a positioning device to assist both adult patients and children. Full ceph projections are made with reduced exposure to tissue and organs in the neck area, and a skullcap is included for children.



CARPUS POSITIONING

A Plexiglas panel representing the carpus helps speed up image acquisition to assess residual growth.



CEPH ARM KEYPAD

Featured on the teleradiographic arm, a convenient keypad is available to adjust column height as part of the positioning procedure for CEPH exams. The keypad can be switched according to which side the CEPH arm is configured on.

CONNECTED CLINIC



Designed to provide connection to the Internet through Easy Check, Castellini's advanced imaging system features a range of optional cutting-edge digital services. With the aim of improving the effectiveness of the clinic, all connected equipment can benefit from a real-time diagnostic service and remote technical support.

VIRTUAL ASSISTANT

Di.V.A. (Digital Virtual Assistant) is the virtual assistant which optimises the workflow of your advanced dental practice. In addition to being viewable on PC, Di.V.A. can be easily consulted on smartphones and tablets.

Through a simple dashboard, the dentist can monitor the equipment's activity in all its functions and analyse the effectiveness of the dental practice. In large dental practices, this is a useful tool to manage significant workloads and plan maintenance activities.



Available across all platforms and operating systems, and with full cloud connectivity making information easily available, the guided surgery software suite, together with smile design solution and automated cephalometric study, ensure the most efficient workflow for all professionals involved. Data sharing, advanced functions and a secure chat lobby for immediate connections are part of these powerful suites designed to optimise and reduce treatment times, perfecting outcome as much as the integrated procedures.

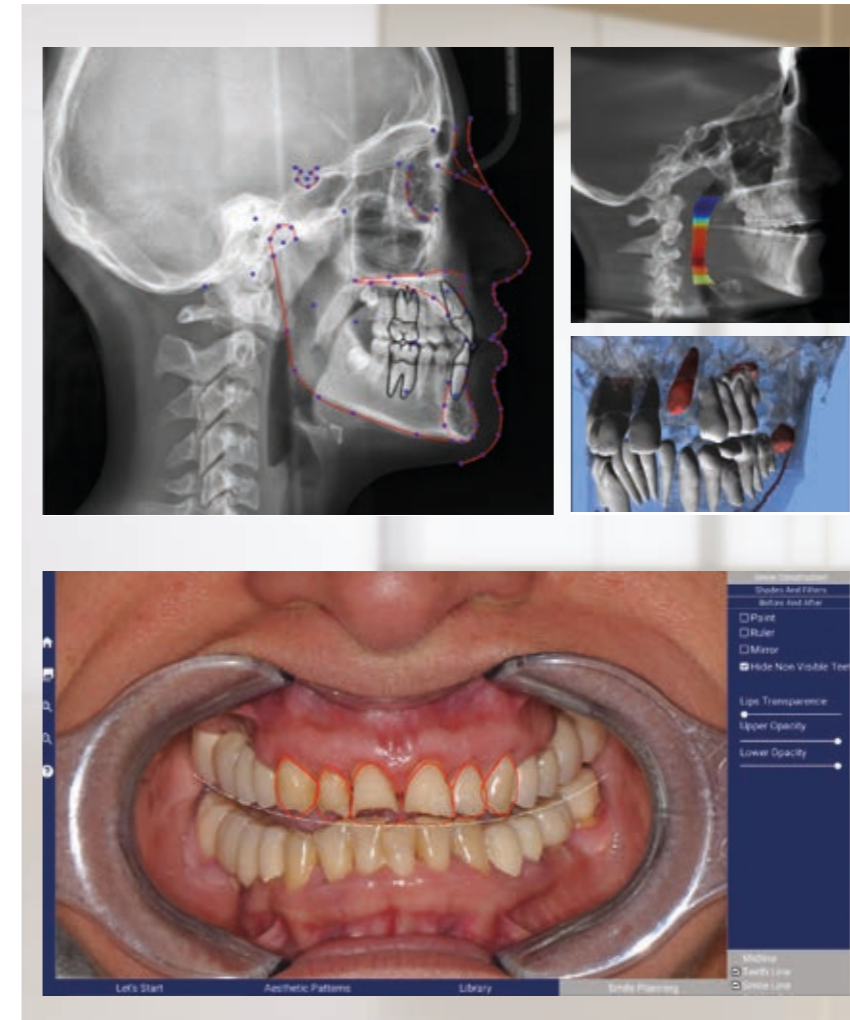

CEPHX

Accessible via web, this cloud-based software uses artificial intelligence (AI) technologies to automate diagnostic and analytical dental imaging tasks, (cephalometric analyses, teeth segmentation, airway volume) thereby increasing case acceptance and productivity.

SMILE LYNX

Peace of mind with Your Smile Design solution: improve communication with the patient by offering him the smile of his dreams in a few, easy steps; share precise information with the dental technician to make it happen.

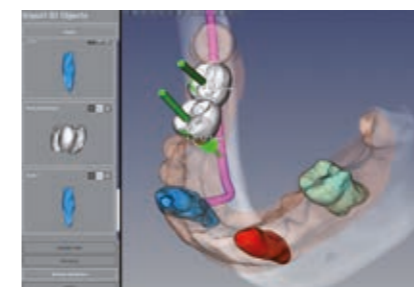

ANATOMICAL SIMULATION

Simulating patient anatomy to facilitate procedures, software provides a precise volumetric environment to perform implant surgery in the safest way.

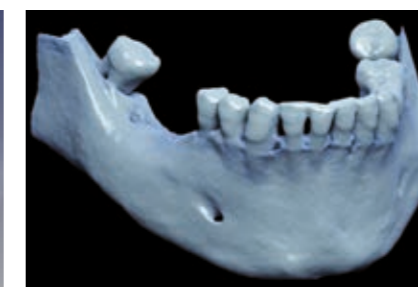

STL FILES

Using artificial intelligence, anatomical structures are segmented and exported as STL files. Data are used to perfect implant procedures.

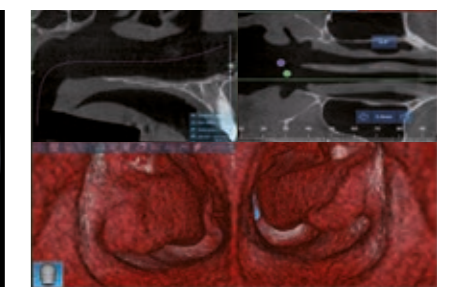

VIRTUAL ENDOSCOPY

The dental surgeon performing implant surgery is able to act according to real data making the operation safer, more effective and minimising the invasive aspects.

TECHNICAL SPECIFICATIONS

DIMENSIONS	PAN AND CB3D	WITH TELERADIOGRAPHIC ARM
Minimum available work space requirement (L x D)	1390 x 1140 mm	1390 x 1800 mm
Package dimensions (HxLxD)	1515 x 1750 x 670 mm (basic machine); 360 x 530 x 1030 mm (telerradiographic arm)	
2-speed motorized column, adjustable height	1660 - 2450 mm	
Weight	155 Kg - 342 lbs	175 Kg - 386 lbs
Notes	Wall or floor support, free standing base available. Accessible for patients on wheelchair	

POWER SUPPLY	AUTOMATIC ADAPTATION OF VOLTAGE AND FREQUENCY
Voltage Frequency	115 - 240 Vac, ± 10% single phase 50 / 60 Hz ± 2 Hz
Maximum current temporary peak absorption	20A at 115V, 12A at 240V
Current absorption in standby mode	20 Watt

CONNECTIVITY	
Connections	LAN / Ethernet
Software	Castellini iRYS (ISDP©10003:2018 conformity in accordance with EN ISO/IEC 17065:2012 Certificate No. 2019003109-1) and iPad App
Supported protocols	DICOM 3.0, TWAIN, VDDS
DICOM nodes	IHE- compliant (Print; Storage Commitment; WorkList MPPS; Query / Retrieve)

dimensions in millimetres (dimensions in inches)

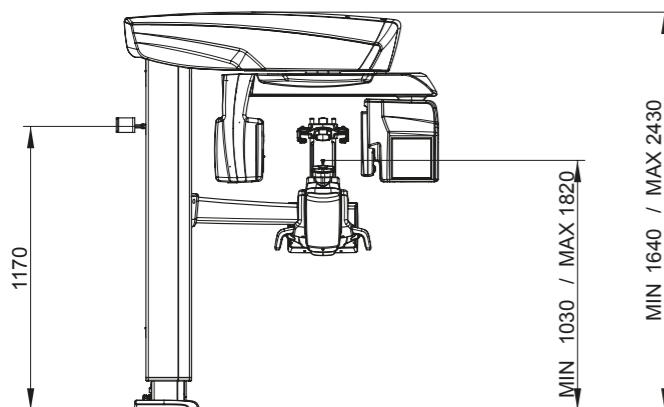

X RADIUS TRIO PLUS

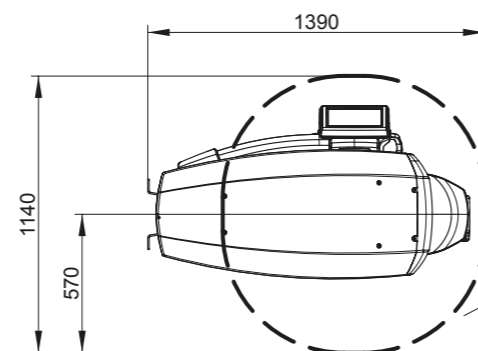

EVERY DIAGNOSTIC DIMENSION - DIRECT CONVERSION

3D IMAGES	FOV EASY VERSION	FOV COMFORT VERSION
Detector technology	Amorphous silicon - CsI with direct deposition	
Dynamic range	16 bit (65,536 grey levels)	
Typical scan time	14.4 s	
Rotation	360°/180°	
Image voxel size	Minimum 75 µm	Minimo 68 µm
Available FOV sizes (Øxh)	6x6 - 8x6 - 8x8 - 10x6 - 10x8	6x6 - 8x6 - 8x8 - 10x6 - 10x8 10x10 - 13x8 - 13x10 - 13x16 4x4 - 7x6 - 9x9 (Extreme Functionality)
Typical image size	495 MB	820 MB
Minimum scan time	6,4 s	3,6 s
Typical X-ray exposure time	1.6 s (Low dose - QuikScan Mode) - 8.0 s (Best Quality - SuperHD Mode)	
Patient alignment	Servo-assisted: Scout View method	
Image format	Exclusive iRYS and DICOM 3.0 software	
Minimum render times for CB3D data	15 s on average	15 s On average, real-time for FOV XF 4x4 QuickScan

2D IMAGES	PANORAMIC X RAY	CEPHALOMETRY
Detector technology	CMOS: STD with scintillator (CsI) or DC (Direct Conversion)	
Pixel size	100 µm	
Dynamic range	16 bit (65,536 grey levels)	
Detector height	STD: 148 mm; DC: 154 mm;	STD: 223 mm; DC: 231 mm;
Image pixel matrix	STD: 1470 x 2562; DC: 1535 x 2583;	STD : 2200 x 2915; DC: 2279 x 2963;
Maximum image file size	8 MB (single image)	14 MB
Typical scan time	6 s - 12.3 s	STD: 3.3 s - 9 s DC 3.3 s -7.5 s
Theoretical image resolution	PAN: 6.3 (pixel pitch of 80µm) BITEWING: 7.5 lp/mm (pixel pitch of 70µm)	CEPH: 5.6 (pixel 90 µm)
Contrast Level	STD: 23% (at 3 lp/mm) DC: 43% (at 3 lp/mm)	STD: 32% (at 2.5 lp/mm) DC: 82% (at 2.5 lp/mm)
Image format	TIFF 16 bit, DICOM	
Patient alignment	Servo-assisted: 4 laser guides	

X-RAY GENERATOR	
Generator type	Constant potential (DC)
Frequency	100 -180 kHz
X-ray emission type	Continuous or Pulsed
Anode voltage	2D SCAN: 60 - 85 kV 3D SCAN: 90 kV (Pulsed Mode)
Anode current	2 - 16 mA
Focal spot	0.5 mm (IEC 60336)
Exposure control	Automatic. X-Safe Technology
Compensation of spine absorption	Automatic (modularity of X-ray beam kV)
mA and kV configuration	Modulated in real time during X-ray exposure, automatically or manually selectable in discrete increments.
Maximum continuous anode input power	42W (1:20 at 85kV/10mA)
Inherent filtration	2D: >2.5 mm Al eq. (at 85 kV) 3D: 6.5 mm Al eq. (at 90 kV)
Integrated X-ray shielding behind receptor	In compliance with IEC60601-1-3

