

Calibration and Checking

BIO-ART ARTICULATORS



INSTRUCTION MANUAL

► INDEX ◀

1 - Introduction..... 1

2 - Components of the Bio-Art Calibration and Checking Kit..... 1

3 - Preparation for calibration..... 2

4 - Calibration..... 3

5 - Checking..... 4

6 - Finalization..... 7

7 - Safety Prescriptions..... 8

8 - Maintenance and cleaning..... 8

9 - Problems and solutions..... 8

10 - Special storage conditions..... 8

11 - Technical assistance..... 9

12 - Warranty terms..... 9

13 - Authorized Representative in Europe..... 9

► 1-INTRODUCTION ◀

Work with interchangeable articulators makes the relation between the dentist's office and the prosthesis laboratory easier. Dentists do not have to send their articulators to the laboratory and vice-versa, they just have to send the plaster model, which will perfectly fit in the other interchangeable articulator, keeping the initial assembly ratio, with no difference in the alignment between the models and the articulator.

The standardized articulator provides a "compensating disk" stuck on the lower frame, which is responsible to eliminate the tridimensional differences, which might exit between the articulator's frames.

The standardization system does not interfere in the assembly procedures. The professional shall keep his conventional working methods.

Standardization is an optional item and it is available for Bio-Art models A7Plus e A7Fix. Model 4000-S cannot be standardized as there is adjustable intercondylar distance, making its calibration impossible.



ATTENTION!

Carefully read and follow all steps described in this manual to assure perfect calibration of the Bio-Art Articulators.

► 2-COMPONENTS OF THE BIO-ART CALIBRATION AND GAUGE KIT

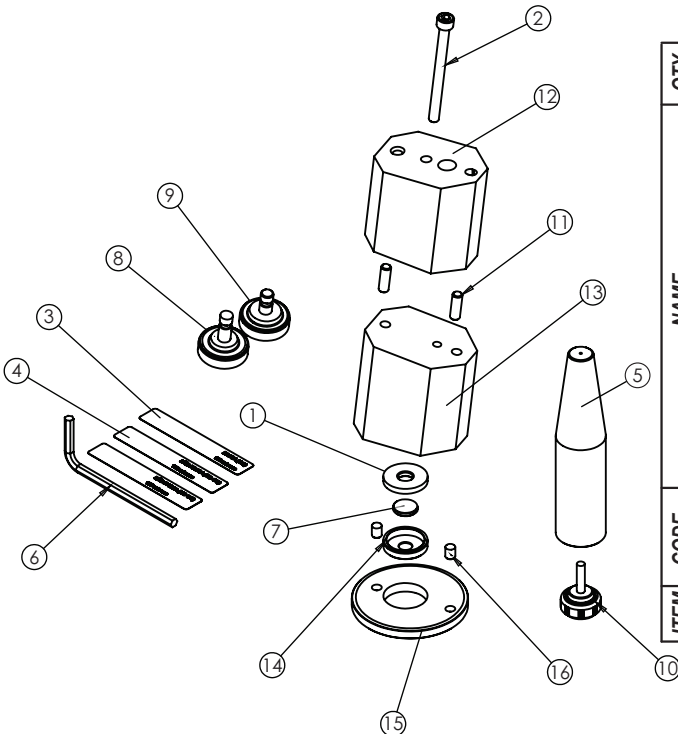

ITEM	CODE	NAME	QTY
1	FAR0787	CAL. BLOCK INSERT WASHER	1
2	CPART135	Gauging Block Screw	1
3	FCBL0687	GO GAGE	1
4	FCLB0688	NO-GO GAGE	2
5	FCOL0686	STANDARD INCISAL COLUMN	1
6	CCAL1136	ALLEN WRENCH 4mm	1
7	CIMA1118	NEODYMIUM MAGNET	1
8	SCRE0082	KNURLED KNOB MOUNTING PLATE ART. A7 FIX	1
9	SCRE0070	MOUNTING PLATE KNURLED KNOB	1
10	SCRE0078	KNURLED KNOB INC. ACRYLIC TABLE	1
11	FP1G0775	CHECKING BLOCK GUIDE PIN	2
12	FBL0685	UPPER FRAME	1
13	FBL0685	LOWER FRAME	1
14	FCAN0791	MAGNET CUP	1
15	FDSC0219	COMPENSATING DISK	1
16	FP1G0076	MOUNTING PLATE GUIDE PIN	2

► 3-PREPARATION FOR CALIBRATION

Remove the Trail mounting plates, its respective magnets and the Incisal Pin of the articulator.

Note: To remove the magnets from the respective housings, use the fixation knob of the Block to force the magnet through the hole on the Frame.

3.1

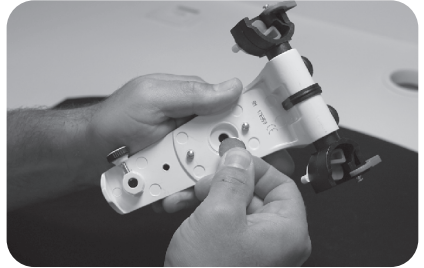

Place the Compensating disk on the lower frame and using a pencil, mark the disk position.

3.2

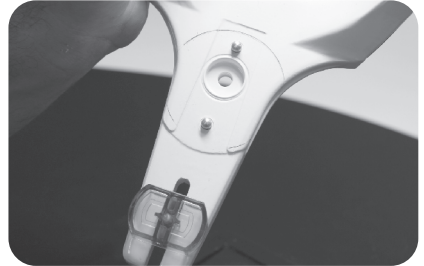

Using a motor and a grinding stone, create retention removing the paint within the outlined area.

3.3

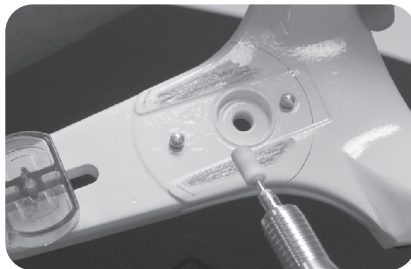

Loosen the central screw of the Block using the Allen wrench supplied in the kit and separate the parts.

3.4



Place the 150-micron gages (NO GO) in the lower part of the Block, place the upper part back and tighten the central screw.

3.5

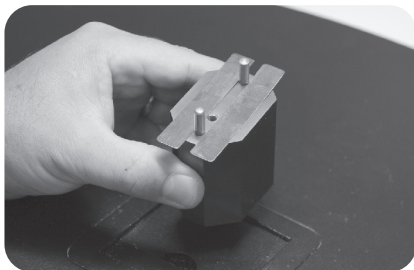

Place the Compensator Disk with magnet on the Block base and fix the set on the upper frame by means of the knob.

3.6

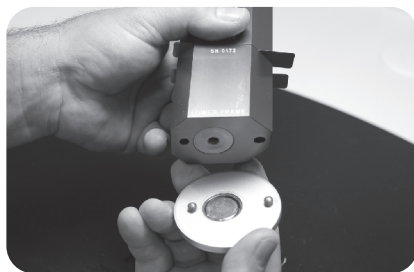

Remove the acrylic Incisal Table and place the Standard Incisal Column.

3.7

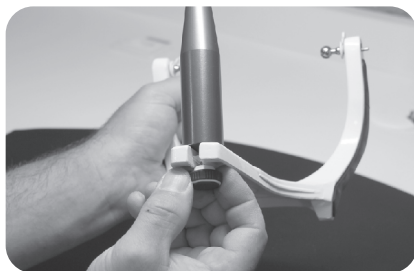
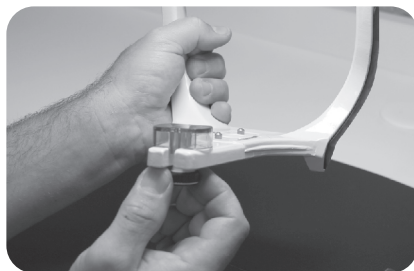

► 4-CALIBRATION ◀

Prepare a mixture of "Epoxy Glue" and apply within the outlines area.

4.1

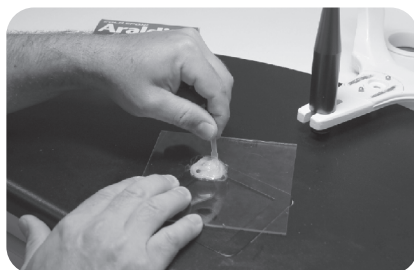

Join the articulator frames and tighten the fixing locks.

4.2



Place the Incisal Column in a way that the marking on the top of the column is in the center of the hole in the Incisal Pin.

4.3

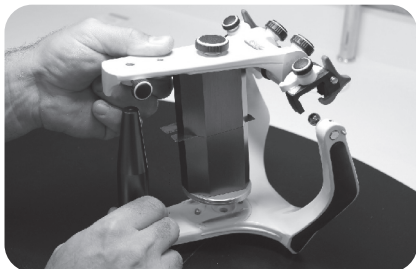

ATTENTION!

The Upper Frame shall be well supported on the top of the Incisal Column.

Put an elastic to keep the frame supported on the column, remove the excess of glue and wait for it to dry according to the manufacturer's instructions.

4.4

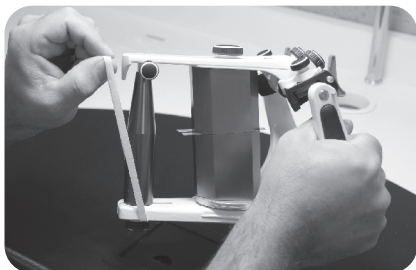

► 5-CHECKING ◀

After removing the elastic, loosening the block fixing screw and the branch fixing locks, remove the calibrating block from the articulator.

5.1

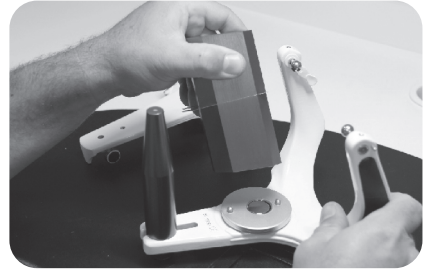
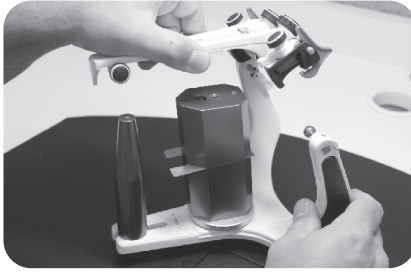

ATTENTION!

The Calibrating Block shall be removed only after the adhesive (glue) has dried completely, respecting the drying time indicated by its manufacturer.

Loosen the central screw of the block and remove the 150-micron gages (NO GO) and the guide pins.

Note: The central screw and the guide pins are used only in the Calibration procedure.

5.2

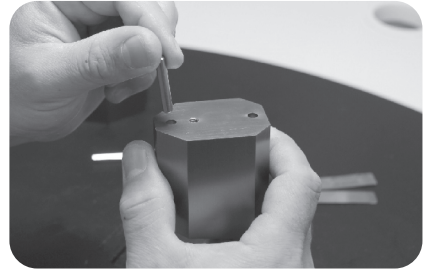
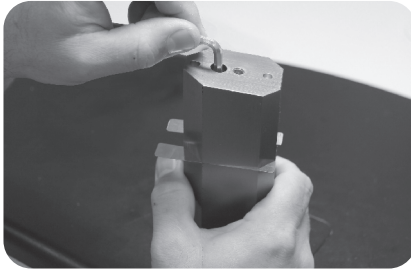

Put the upper and the lower parts of the block again in their respective articulator frames.

5.3



Join the frames and tighten the fixing locks.

5.4



Confirm whether all faces of the block are aligned. For this purpose, rub your finger or finger nail on the joint edge of the upper and the lower parts of the Block.

Appearance of any irregularity (misalignment or step) means that the calibration has not been successful and shall be repeated.

5.5

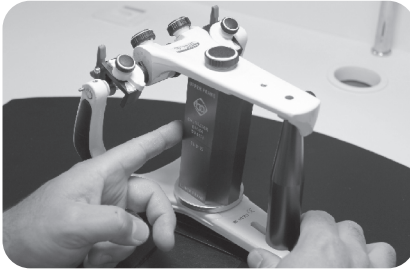

Between the two parts of the Calibrating Block, there shall be a small opening, which may vary between 100 and 150 Microns.

Introduce the Calibrating and Checking gages between the parts of the block. The 100-micron Checking Gage (GO) shall slide freely, while the 150-micron Calibrating Gage (NO GO) penetrates with some difficulty.

Note: The Standard Incisal Column must be kept in contact with the upper frame to maintain the parallelism between the upper and the lower frames. For this purpose, use an elastic between the frames.

5.6



100-micron Gage
(GO)



150-micron Gage
(NO GO)



ATTENTION!

In case the checking shows something out of specification in relation to the face alignment and/or the measurement of the opening between the block parts, recalibration shall be done. For this purpose, unstick from the Compensating Disk, clean the adhesive residues remaining on the Lower Frame and on the Compensating Disk well, and prepare the material again to start the calibration procedure as described at the beginning of this manual, taking double care when adjusting the Articulator and during the bonding procedure.

► 6-FINALIZATION ◀

Put your articulator in the original configuration procedure.

6.1



THAT'S IT!

Your articulator is already standardized and ready for use!



Important Note:

In the daily work, there might be an accidental shock or any other problem, which might impair the calibration; therefore, it is recommendable to check the Articulator constantly to make sure it keeps the same precision obtained during its calibration. If any problem is detected during the check, the calibration procedure shall be repeated.

► 7-SAFETY PRESCRIPTIONS ◀

This manual contains technical information related to only to the Articulator standardization.

Even when standardized, the Articulator is designated for use only by specially qualified professionals from the area, in order to obtain a precise final result from the work.

Before using the standardized Articulator, the professional shall check its standardization and whether there are other accessories damaged.

Always check whether the magnet surface is clean and free of any residue.

When any abnormality is detected, call the Bio-Art Technical Assistance or an Authorized Representative.

► 8-MAINTENANCE AND CLEANING ◀

To clean the Standardized Articulator and all components of the standardization and checking kit use only a soft sponge and cool water. Never use solvents, metal spatulas or sharp objects. Keep the mobile parts of the standardized articulator and mainly the magnet surfaces always clean and free of dust or accumulation of plaster, in order to assure free movement and precision on fixing.



All and any maintenance of the Bio-Art articulators shall be made by the Authorized Technical Assistance.

► 9-PROBLEMS AND SOLUTIONS ◀

PROBLEM	POSSIBLE CAUSE	SOLUTION
Standardization precision misadjusted.	Incorrect standardized procedure.	Perform the checking operation; if necessary, recalibrate according to the procedures in this manual.
The mounting plates do not fit.	Damaged orifices of the plates.	Replace the mounting plates.
Irregular fixing of the (mounting plates).	Accumulation of residues on the frames.	Check and clean the frame face supporting the plates.
	Accumulation of residues in the plate orifices or on the magnets.	Check and clean the orifices to fit the guide and the magnet pins.
Checking difficulty and irregularities.	Fall or undue use.	Recalibrate or contact the Authorized Technical Assistance.
Fixing gap on the checking block.	Residues on the magnet or inside the magnet cup.	Remove the magnet from the cup and clean it completely, as well as the internal part of the cup.

► 10-SPECIAL STORAGE CONDITIONS ◀

The Standardized Articulator together with the components of the calibration and checking kit compose a precision device and shall be handled, transported and stored carefully.

With the purpose to assure its precision during transport, Bio-Art provides a plastic casing developed exclusively for the articulator to be transported safely. Even conditioned in its respective casing for the product to keep its quality and precision, avoid falling, mechanical and physical shocks.

When not used for a long period, keep it clean, free of humidity and conditioned in its respective casing, in a dry place and far from sources of heat and direct sunlight.

► 11-TECHNICAL ASSISTANCE ◀

For your safety, the technical assistance for this product shall be performed by authorized people/companies. Check out the Authorized Technical Assistance posts in our site: <http://www.bioart.com.br>

► 12-WARRANTY TERMS ◀

BIO-ART Equipamentos Odontológicos Ltda. grants 1-year warranty from the date of acquisition of the product (purchase tax receipt). The warranty is provided exclusively by the authorized distributor and includes any manufacturing defect, considering that it is performed by repairing the product and is subject to the following conditions:

- That the product has been used correctly, according to the instructions described in the instruction manual;
- The complaint is presented together with the purchase invoice and recorded within the warranty period, followed by a report with description of the defect and the serial number of the product;
- The product has been used, transported and stored carefully; The transport cost (round trip) shall be paid by the customer;

Warranty limitations:

- Natural wear of parts;
- Misuse, drop or disasters;
- Inadequate transport;
- Repair by non-authorized people;
- Use not in conformity with the product characteristics and purpose;
- Wear due to exposure to adverse conditions (humidity, cold and intensive heat);
- Damages due to lack of cleaning or maintenance with inadequate products;

In case of doubt, contact the manufacturer:

BIO-ART EQUIPAMENTOS ODONTOLÓGICOS LTDA.

Rua Teotônio Vilela, 120 - Jardim Tangará CEP 13568-000 - São Carlos - SP - Brazil
Tel. +55 (16) 3371-6502 www.bioart.com.br - E-mail: bioart@bioart.com.br CNPJ
58.538.372/0001-56 - I.E. 637.034.447.113

► 13-AUTHORIZED REPRESENTATIVE IN EUROPE ◀

Obelis s.a

Boulevard Général Wahis 53 1030 Brussels, BELGIUM
Tel: +(32) 2. 732.59.54 - Fax: +(32) 2.732.60.03 - E-Mail: mail@obelis.net

