

Technical
Instructions
Manual

Articulators and Facebow

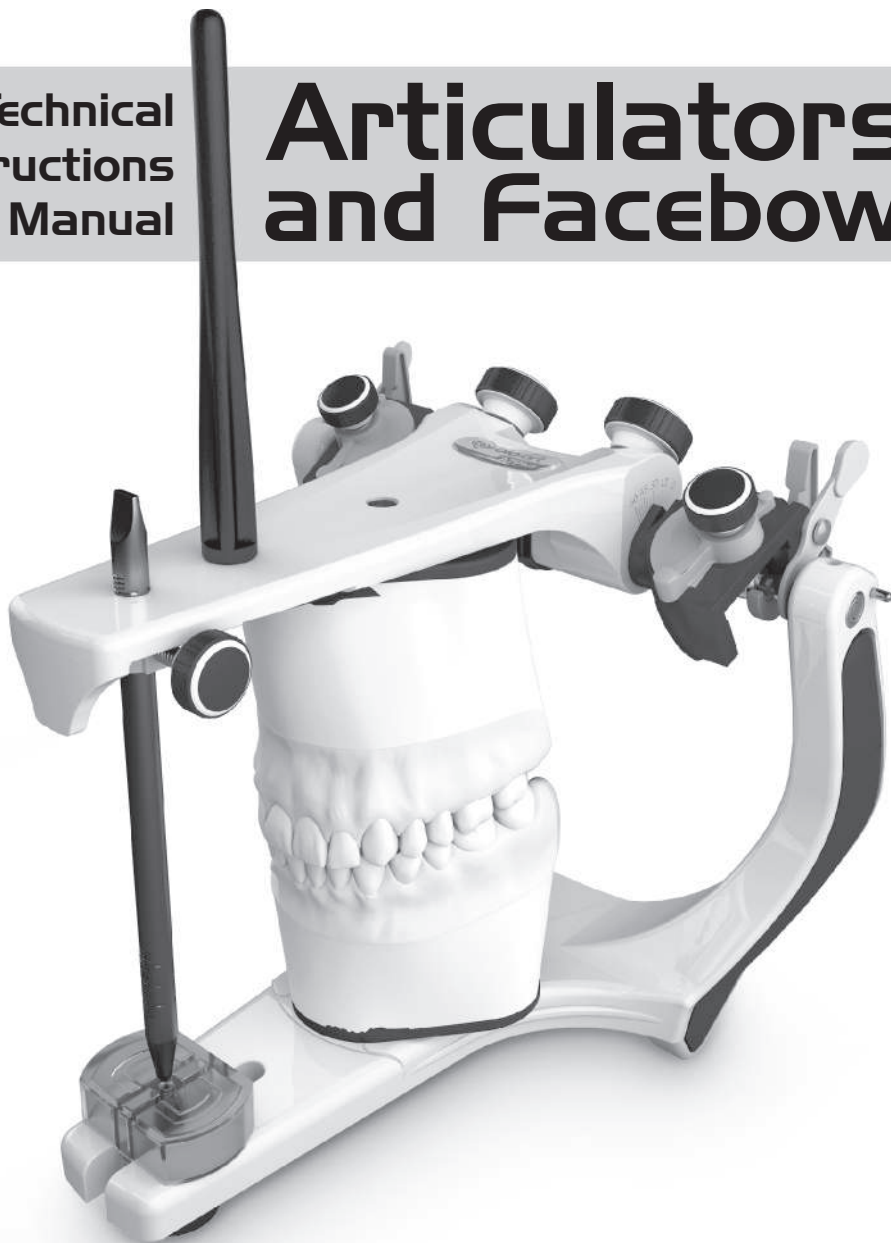

WATCH THE MOVIES



 **bio·art**
intelligent solutions
<https://stomshop.pro/>



NOTE:

All rights reserved. No part of this publication may be reproduced, stored in a retrieval system, or transmitted, in any form or by any electronic, mechanical, photocopying, recording or other means, without the prior written consent of Bio-Art Equipamentos Odontológicos Ltda.

Authorised Representative in the European Community:

Obelis s.a

Boulevard Général Wahis 53

1030 Brussels, BELGIUM

Tel: +(32) 2. 732.59.54

Fax: +(32) 2.732.60.03

E-Mail : mail@obelis.net

<https://stomshop.pro/>

► CONTENTS ◀

01	-	Introduction	01
02	-	Standard Face-Bow registration procedure	02
		2.1 - Dentate and partially dentate patients	02
		2.2 - Totally edentulous patient	04
03	-	Mounting the casts on the Articulator	05
		3.1 - Preparing the Articulator	05
		3.1.1 - Articulator Model 4000-S	05
		3.1.2 - Articulator Model A7 Plus	06
		3.1.3 - Articulator Model A7 Fix	06
		3.2 - Mounting the upper cast	07
		3.2.1 - Standard Face-Bow	07
		3.3 - Interocclusal Registration	08
		3.4 - Mounting the Mandibular Cast	08
		3.5 - Particularities of the Rail Mounting Plate	09
04	-	Special features of the Bio-Art Articulators	10
05	-	Special features of the Standard Face-Bow	11
06	-	Accessories	11
07	-	Safety Rules	12
08	-	Technical Service	12
09	-	Guarantee	13
10	-	Part List Articulator 4000-S	14
11	-	Part List Articulator A7 Plus	15
12	-	Part List Articulator A7 Fix	16
13	-	Part List Standard Face-Bow	17
14	-	Symbols	18

► 1 - INTRODUCTION ◀

IMPORTANT NOTE: Before using your BIO-ART articulator, please read carefully all the Instructions Manual.

The articulator is an instrument used to simulate the maxillo-mandibular relation and movements of a patient in a laboratory, with the purpose of studying the occlusion and production of dental devices that will be used by the patient. These devices include complete dentures, partial dentures, bridges, crowns and bite plate, among others.

The face-bow is an instrument used to register the position of the patient's dental arcade in relation to the skull and transfer this record to the articulator.

The BIO-ART semi-adjustable articulators are Arcon type conventional equipment (models 4000-S, A7 Plus and A7 Fix) and Non-Arcon type model EVA. Therefore, the mounting technical procedures are the same for these articulators.

This Manual contains only basic and simplified information regarding the use of the equipment, which do not replace the need of a specific course of Occlusion and/or Prosthesis, offered in many Teaching Institutions and Dental Faculties, as a compulsory discipline.

IMPORTANT NOTE: The use of the equipment by professionals not qualified can cause damage or harm to the product and/or patient.

The articulator and face-bow's use are restricted to qualified professionals.

It is important to emphasize, however, that the semi-adjustable articulator and face-bow provide a simple, fast and highly precise way of reproducing the human mandible movements, enabling the dental professional to carry out corrective and restorative dentistry tasks more easily, rapidly and at lower costs than those of traditional, time-consuming techniques involving expensive and highly complex equipment. Furthermore, the semi-adjustable articulator and face-bow produce far more accurate results than those produced by "simple hinge" articulators, which involve arbitrary mounting of the mandibular cast on the device and whose movements are also limited.

The use of the semi-adjustable articulator and face-bow is therefore recommended for most prosthetic, occlusal and rehabilitation work. The technique is simple, fast and easy, offering highly satisfactory results for both the patient and professional.

2 - STANDARD FACE-BOW REGISTRATION PROCEDURE



FIG. 1

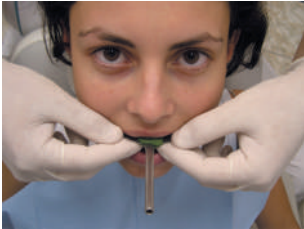

FIG. 2



FIG. 3

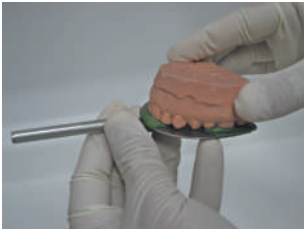

FIG. 4

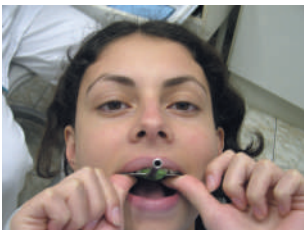

FIG. 5

2.1 - DENTATE AND PARTIALLY DENTATE PATIENTS

a) By using bite registration material ("godiva", wax, among others) three points on the fork are made: one frontal point, in the exact centre of the fork, and two points at the back, one at each semi-arch of the fork (fig. 1).

b) Position the bite fork so that the midline of the fork handle is aligned with the midline of the maxilla and place it on the upper teeth, holding it firmly in place until the registration material hardens (fig. 2). Only a small amount of registration material should be used since the purpose is to record only the cusp tips of the teeth while keeping the fork as immobile as possible (fig. 3).

Afterwards it is advisable to try the cast on the registration to check its stability (absence of clearance) (fig. 4).

Note: Alternatively, a pre-impression of the teeth can be made on the upper model and then refined in the mouth.

In the case of patients who have partially jagged teeth, it is important to locate points that hold the fork stably in place, despite the missing teeth and the points used for the transfer.

c) Recline the patient in the chair to reduce the induction of tensions on the fork set and face-bow asking him to keep the fork in the same position, supporting the thumbs against the maxilla (fig. 5). Take the face-bow to the patient and introduce the fork fixation assembly into the bite fork handle, assuring that the wing nut is upside down (fig. 6). Then carefully insert the face-bow earpieces into the patient's external auditory meatus as if you were putting a stethoscope into his ears (fig. 7).



FIG. 6



FIG. 7



FIG. 8

- d) Place the nasion relator on the face-bow cross bar, when using the face-bow Standard. For both models, centre the nosepiece on the patient's nasion. Attention to the correct position of the nazium relator as indicated in picture 7.5b. The earpieces should now be carefully positioned as deeply as possible in the patient's auditory meatus and the nosepiece should be gently pressed against the patient's nasion while tightening the wing nuts of the nazium relator assembly (fig. 8). Afterwards, tighten the three screws of the Standard face-bow (fig. 9 and 14).

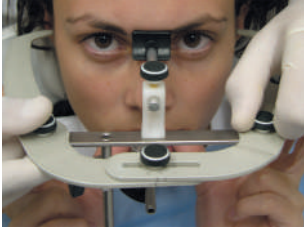

FIG. 9

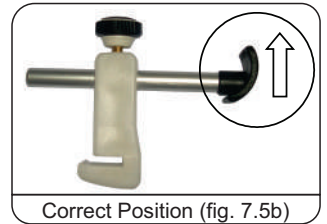
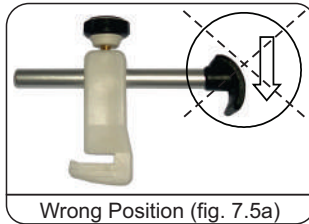

FIG. 10

- e) With the nazium relator and the face-bow tightened and the patient holding the fork immobile, push the fork fixation assembly forward, sliding it on the fork handle until it is as close as possible to the lips, without touching them, in order to achieve increased stability. Then tighten the wing nuts of the fork: first the double articulated nut (connection block) (fig. 3) and then the horizontal slide bar nut, so that the fork is supported at one end of its handle, resulting in less tension on it (fig. 10 and 11). To ensure proper registration, ask the patient to remove his thumbs from the bite fork and check if the fork and the face-bow are stable and immobilized (fig. 12).

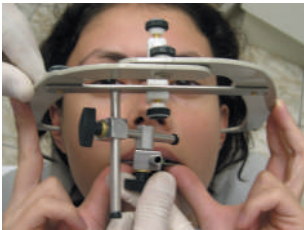

FIG. 11

- f) When using the articulator model 4000-S, record the approximate intercondylar distance, whose reading is taken on the front edge of the face-bow Standard. The three numbers (1, 2 and 3), separated by a reference mark, correspond to the intercondylar distances: small, medium and large. When the reference mark is aligned with the distance indicator, always use the smallest distance for the patient. This information should be registered in the patient's records for subsequent adjustment of the articulator.



FIG. 12

Note: In other articulator models, the intercondylar distance is fixed at an average of 110mm and the intercondylar distance is not adjustable. In this case, disregard the above-described registration of the face-bow.

- g) Loosen the wing nut of the nosepiece and remove the nazion relator assembly from the face-bow. Then, loosen the central wing nut of the face-bow and hold the cross bar of the bow at the same time the patient opens the mouth slowly, removing the whole set carefully (fig. 15, 16 and 17)



FIG. 15



FIG. 16



FIG. 17

2.2 - TOTALLY EDENTURELESS PATIENT

- a) When registering totally edentureless patients with the face-bow, use the special edentureless fork, or Conti fork (optional), to maintain the prove plate and roller wax.
- b) After the patient's registration on the wax roller, heat both handles of the fork slightly in a flame and press them on the upper wax roller, which was previously joined to the lower wax roller, or not, with the midline of the fork handle aligned with the midline of the patient (fig. 18, 19).
- c) Place the set (fork + wax rollers) in the patient's mouth inserting it on the alveolar edges (fig. 20)

Note: When carrying out the registration with wax rollers which were previously joined, ask the patient to keep it in position and close his mouth.

- d) Repeat steps (c) to (g) of item 2.1



FIG. 18



FIG. 19

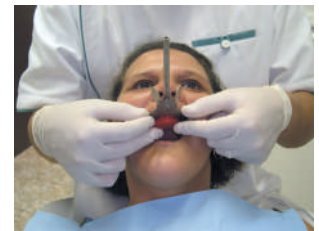

FIG. 20

3 - MOUNTING THE CASTS ON THE ARTICULATOR



FIG. 21

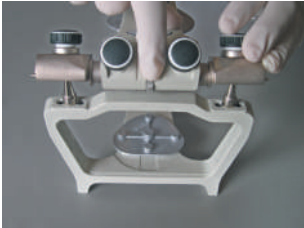

FIG. 22



FIG. 23



FIG. 24

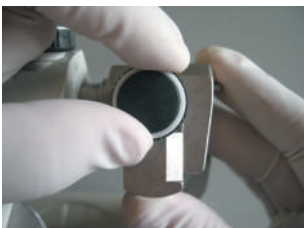

FIG. 25

3.1 PREPARING THE ARTICULATOR

The adjustments of the articulators mentioned below are only used to mount the casts on the articulator. However, the professional may choose to use other angulation techniques to personalize the settings.

The marks 1, 2 and 3 of the Face Bows are used to adjust the intercondylar distance (small, medium, large), when the mounting is carried out with the Articulator Model 4000-S. For the other articulators models, it must be ignored.

3.1.1 Articulator Model 4000-S

- Fix the condylar elements into the lower frame holes according to the patient's registration (1, 2 and 3) made with the face-bow. With the help of the condylar element shaft, tighten the condylar elements slightly (fig. 21).

- Adjust the same intercondylar distance in the upper frame, expanding or closing the condylar guide with the micrometric expanding spindle (fig. 22).

Note: To facilitate adjustment of the intercondylar distance of the upper frame using the micrometric spindle, leave the wing screw of the condylar guide inclination slightly loose.

The relationship between the intercondylar distance and the positioning of the condylar guide is given as follows:

*Small = without expansion (condylar guide totally closed)

*Medium = first marking on the condylar guide axle

*Large = second marking on the condylar guide axle

Important: A fine adjustment should be made to prevent lateral movements of the upper frame in relation to the lower frame observing that the position of the condylar elements should be touching the posterior and superior walls of the condylar guide and the lateral of the benett angle adjusting device simultaneously (fig. 23) i.e., the reference mark for the adjustment of the intercondylar distance in the condylar guide axle does not always coincide with the correct position of adjustment of the upper frame. A fine adjustment is therefore necessary, using the expanding spindle.

- Adjust the condylar guide at a 30° angle and a negative "Benett" angle (fig. 24 and 25), assuring the stability of the articulator at a central position.

3.1.2 - Articulator Model A7 Plus

To facilitate the mounting of the casts, adjust the Condylar Guides angles at 30° and the Bennet at 0° (fig. 29 and 30). Then push back the upper part of the central lock until feel the “click” (locked position fig. 31).

PS.: In order to make sure that the Articulator A7 Plus is totally locked at the centric position, check if the 2 locks (left and right) are at the locked position.



FIG. 29



FIG. 30



FIG. 31

3.1.3 - Articulator Model A7 Fix

Aiming as main characteristic simplicity and easiness to work, the A7 Fix Articulator was developed with the Bennet and Condyle angles fixed at the average of 15° and 30°, respectively. The intercondylar distance was also fixed at the average of 110 mm. Therefore, this model does not require preliminary adjustments for these components, such as the other models previously mentioned. In order to lock the Articulator A7 Fix in the centric position, there is an innovative system with two lateral pins, denominated: “centric lock pin”. This pin has 3 main positions: first position - totally closed (locks the articulator in the centric position - picture 32); second position - intermediate (releases the articulation movements - picture 33) and third position (allows to remove the upper from the lower frame - picture 34).



FIG. 32



FIG. 33



FIG. 34

3.2 - MOUNTING THE UPPER CAST

3.2.1 Standard face-bow



FIG. 39



FIG. 40



FIG. 41

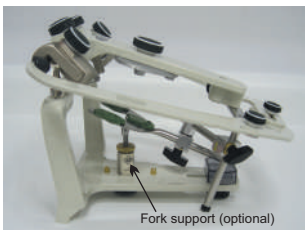

FIG. 42

The Standard face-bow should only be used with the articulator model 2000, 4000-S and 5000. It should not be used with the EVA Fix and EVA Plus models.

- Fix the face-bow Standard to the upper frame of the articulator by fitting the earpiece holes on the small pins located on the external edge of the condylar guide (fig. 39).
- Support the front part of the Articulator Upper Frame on the cross bar of the face-bow. Close the face-bow firmly by fastening the central face-bow wing nut and placing the whole face-bow together with the upper frame on the lower frame of the articulator (fig. 40,41 and 42).
- Place the upper cast, with retentions and previously hydrated, on the fork registration. Lift the Upper Frame of the articulator, depositing a small amount of plaster on the Upper Mounting Plate and a portion on the top of the Upper Cast. Then, using one of your hands, keep the fork and the cast in position, avoiding any movement of the Bite Fork and carefully hinge the Upper Frame until it touches the cross bar of the face-bow. Wait for the plaster to harden (fig. 43).

Note: The sides of the mounting plates, which are in contact with the articulator frames, should be devoid of plaster.

Important: In order to achieve greater stability and precision during the transfer procedure, it is advisable to use the Fork Support (optional) and plaster type IV (fig. 44).

- Remove the face-bow from the articulator.



FIG. 43

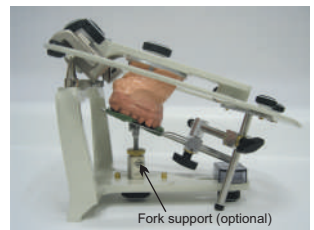

FIG. 44



FIG. 54



FIG. 55



FIG. 56



FIG. 57

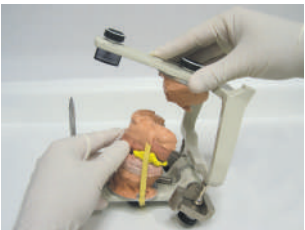

FIG. 58

3.3 - INTEROCCLUSAL REGISTRATION

To set up the mandibular (lower) cast in the articulator, you should have a record correlating the upper and lower dental arches, according to the purpose of the mounting, in one of the following ways:

Maximum Intercuspation (MI);
Centric Relation (CR);

These records can be made using material of the operator's preference: wax, resins, addition or condensation silicon, etc. (fig. 54 and 55)

To obtain the M.I registration, place the selected material to register the patient's arcade and ask him to occlude.

There are several techniques to obtain the R.C registration, i.e. Peter Dawson's technique (bilateral manipulation of the mandible), Lucia's JIG technique and James Long (use of plastic spacer) among others.

Note: For totally edentulous patients, this registration is made when the upper and lower wax rollers are joined based on the correct dimensions of the patient.

3.4 - MOUNTING THE MANDIBULAR CAST

- Place the Incisal Guide Pin in the Upper Frame of the articulator with its rounded tip pointing downward so that the upper and lower frames are parallel, i.e. on the zero marking of the Incisal Guide Pin (fig. 56)
- Now turn the articulator upside down on the laboratory bench and affirm the lower cast, with retentions and previously hydrated, upon the interocclusal register that should be placed in the mounted upper cast (fig. 57). In totally edentulous patients, this was obtained by joining the wax rollers together.
- We recommend fixing the casts with rubber bands or staples (fixed with "godiva" or wax) so that they remain in position until the plaster hardens. Place a small amount of plaster on the lower part of the mandibular cast and a small amount on the mounting plate of the lower frame of the articulator to fill in the gap between them (fig. 58).



FIG. 59

- d) Make sure the condylar elements are duly positioned and close the lower frame until the Incisal guide pin touches the Incisal table. Afterwards, fasten the articulator frames using rubber bands to prevent possible distortion occurred by the plaster expansion (fig. 59)

Note: The sides of the mounting plates, which are in contact with the articulator frames, should be devoid of plaster.



FIG. 60

- e) After the plaster hardens, turn the articulator back to its upright position (lower frame resting on the laboratory bench) and complete the work, filling the cast fixation towers with plaster for the finishing touches (fig. 60).



FIG. 61



FIG. 62

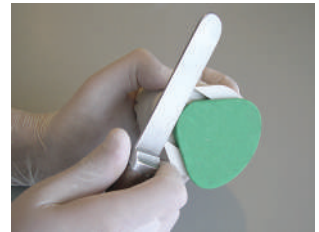

FIG. 63

3.5 PARTICULARITIES OF THE RAIL MOUNTING PLATE

The Rail Mounting Plate was specially developed to allow the removal of the plaster cast without the needs of breaking it, as occurs in most of the conventional mounting plates.

In order to use of this resource satisfactorily, the professional should take some cares, mainly during the confection of the cast, and afterwards when handling the removal of the plate, according to the following procedure:

- The plaster finishing on the edge of the mounting plate should be done in such way to avoid excess of plaster around the edge and to allow the splitting and the sliding of the plate afterwards, i.e., during the removal procedure (fig. 61).
- Before the removal of the cast, the plaster contained in the retention hole should be removed with an instrumental tip. The function of this retention hole is to avoid displacement of the plate when handling the cast (fig. 62).
- Once the plaster contained in the retention hole is removed, the cast should be firmly held and a slight strike must be applied on the edge of the plate, in the direction of the arrows stamped in the plate lower face. This procedure will detach the mounting plate from the cast and enable its removal through the sliding (fig. 63).

PS: Once the cast is removed from the rail mounting plate, we do not assure its returning to the initial precision since it depends on the technique applied and quality of the materials used in the process (specially the plaster).

4 - SPECIAL FEATURES OF THE BIO-ART ARTICULATORS

Features	Model	4000-S	A7 Fix	A7 Plus
Classification		Arcon	Arcon	Arcon
Condylar Guide		Adjustable / Curve	Curve Fixed at 30°	Adjustable / Curve
Bennet Angle		Adjustable	Fixed at 15°	Adjustable
Intercondylar Distance		Adjustable *	Fixed at 110 mm	Fixed at 110 mm
Central Lock		No	Yes	Yes
Stabilization System **		Elastic Band (O'ring)	Magnetic	Silicone Connection

* Adjustment made through the micrometrical expanding spindle. (Bio-Art's exclusive system)
 ** Joining system between the upper and lower frames provides stability during articulating movements.

Interchangeable Articulators (Optional)
 Bio-Art's interchangeable articulators are standardized (calibrated) by the manufacturer to allow for interchangeability of the casts among these articulator models. Only model 4000-S cannot be supplied in the standardized option.



Mod. 4000-S



Mod. A7Fix



Mod. A7Plus

► 5 - SPECIAL FEATURES OF THE STANDARD FACE-BOW ◀



5.1 - STANDARD FACE-BOW

The Bio-Art Standard model is simple and easy to work with. It has manually tightened wing nuts to fix the fork, eliminating the inconvenient use of the key. In this model, the registration of the position of the patient's upper dental arcade in relation to the skull is transferred to the articulator by setting the complete face-bow in the upper frame assembly of the articulator (chapter 3 Item 3.2.1)

The Standard Face Bow can be used with the all Articulators models, its use is forbidden with the Models EVA Fix and EVA Plus.



FIG. 64

5.3 - INSTRUCTIONS FOR USE THE NOSE PIECE SUPPORT

Slide the Nose Piece Support in the Face-Bow's Cross Bar through the groove, pressing it until realize a slight "click" indicating that the support is fully embedded. The support may be laterally moved, so that it can be placed in the position desired by the operator (fig. 64).



FIG. 65

To withdraw the Nose Piece Support, make a movement of twist to facilitate its removal (fig. 65).

► 6 - ACCESSORIES ◀

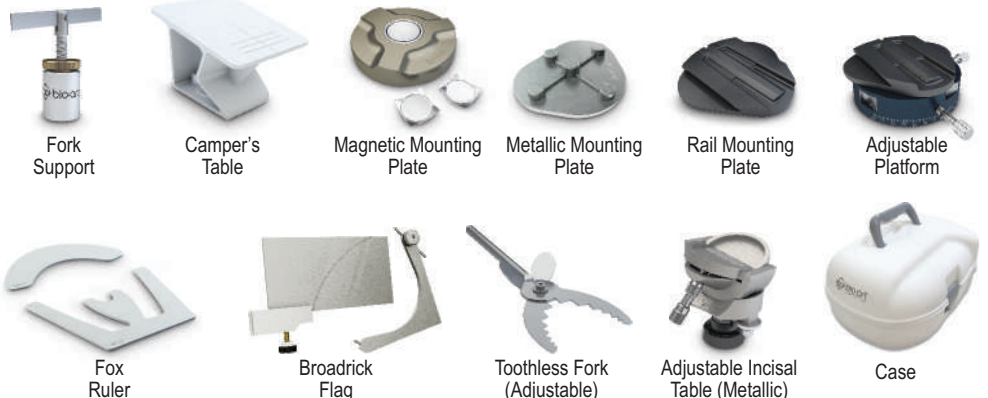

7 - SAFETY RULES

- This manual only contains basic and simplified information regarding the use of the instrument and under no circumstances it is a substitute for a proper training course. The articulator and face-bow are products aimed at the exclusive use of qualified dental professionals.
- The Bio-Art face-bow is designed for use with Bio-Art's own articulator and vice-versa. Although, the Standard face-bow is compatible with other articulator models, its use with similar models should be consulted.
- Bio-Art articulators are not interchangeable, i.e. the casts mounted on one articulator model should not be transferred (mounted) to any other articulator. Therefore, Bio-Art does not guarantee precision when casts mounted on one articulator are transferred to another.
- The only Bio-Art articulators, which are interchangeable, are those which are calibrated in the factory. Thus, for safe and precise interchangeability, casts should be transferred only between calibrated articulators.
- Before using the articulator and face-bow, the professional should check the instrument for possible damage, distortion of the incisal pin, face-bow's parallelism, proper centricity of the incisal pin in relation to the lower frame, etc. Should any abnormality be found, Bio-Art's Technical assistance or Authorized Representative should be contacted immediately.
- The face-bow should be cleaned with warm water prior to its use. The Bite Fork must be autoclaved and the Earpieces disinfected with a bactericide or with 70° alcohol.
- Bio-Art recommends only warm water for the general cleaning of the articulator and face-bow.
- When using "godiva" or any other registration material, special care should be taken to avoid excessive heating of the material, which might burn the patient's mouth. Bio-Art urges the user to carefully follow the instructions of the registration material manufacturer.
- Because the articulator is a precision instrument, it should be handled, transported and stored carefully. Bio-Art provides a plastic case (optional accessory) exclusively designed to accommodate the articulator and to facilitate its transportation.

8 - TECHNICAL SERVICE

For your safety, the technical service of this product should be made by people/companies authorized by BIO-ART. Please contact us or the distributors, where the product was acquired.

Our web site is: www.bioart.com.br

► 9 - GUARANTEE ◀

Bio-Art Equipamentos Odontológicos Ltda., grants 1 year warranty, starting from the date of the device purchase (invoice). The warranty is carried out exclusively by the authorized distributor and includes any manufacturing defect, being provided through the repairing of the product and subjected to the following requirements:

- That the product has been used correctly in accordance with the instructions described in the user manual;
- The claim is followed by the invoice and registered within the warranty period, accompanying a report with description of the damage and product serial number;
- The product is handled, transported and stored with care;
- The costs of transport (from and to) is paid by the customer;

Warranty limitations:

- Natural wears and tear of parts;
- Misuse, falls or accidents;
- Inadequate transportation;
- Repair by unauthorized person;
- Use in disagreement with the features and purposes of the device;
- Wear from exposure to adverse conditions (humidity, cold and heat);
- Damage from lack of cleaning or maintenance with inappropriate products.

In case of doubt, contact the manufacturer:

BIO-ART EQUIPAMENTOS ODONTOLÓGICOS LTDA.

Rua Teotônio Vilela, 120 - Jardim Tangará

CEP 13568-000 - São Carlos - SP - Brasil

Tel. +55 (16) 3371-6502 - Fax +55 (16) 3372-5953

website: www.bioart.com.br - E-mail: bioart@bioart.com.br

CNPJ 58.538.372/0001-56 - I.E. 637.034.447.113

10 - PART LIST - ARTICULATOR 4000-S

Item	Unit	Qty.	Code	Description
01	UM	1	FRAM1069	LOWER FRAME 4000-S
02	PC	2	FCAN0755	MAGNETIC FITTING
03	UM	2	FECDO049	CONDYLE ELEMENT
04	UM	4	COR11170	STABILIZING ELASTIC BAND (O RING)
05	UM	2	CIM11118	RAIL MOUNTING PLATE MAGNET
06	UM	4	FPG0076	MOUNTING PLATE GUIDE PIN
07	UM	2	CPIE1524	AFFIXING BLOCK PIN
08	UM	1	SALH0075	BENNETT ANGLE ADJUSTING DEVICE (RIGHT)
09	UM	2	FPG0062	FACE BOW'S GUIDE PIN
10	UM	1	FCDL1066	CONDYLAR GUIDE (RIGHT)
11	PC	1	FPOS0759	POSITION INDICATOR OF BENNETT ANGLE ADJUSTING DEVICE (RIGHT)
12	UN	2	SCRE0099	SCREW TO FIX THE BENNETT ANGLE ADJUST. DEVICE
13	UN	1	FBCH0059	CONDYLAR BUSH (RIGHT)
14	UN	1	FFUS0042	MICROMETRIC EXPANDING SPINDLE
15	UN	1	FRLD0061	PULLEY
16	UN	2	SCRE0008	CONDILAR GUIDE WING SCREW
17	UN	2	FFIX0057	CONDYLAR GUIDE FIXER
18	UN	1	SCRE0010	MOUNTING PLATE SCREW (UPPER)
19	UN	1	FBCH0060	CONDYLAR BUSH (LEFT)
20	PC	1	FPOS0758	POSITION INDICATOR OF BENNETT ANGLE ADJUSTING DEVICE (LEFT)
21	UN	1	FCDL1067	CONDYLAR GUIDE (LEFT)
22	UN	1	SALH0074	BENNETT ANGLE ADJUSTING DEVICE (LEFT)
23	UN	1	SCRE0011	INCISAL PIN SCREW
24	UN	1	FRAM0056	UPPER FRAME 4000-S
25	UN	4	SPLA0079	RAIL MOUNTING PLATE
26	UN	1	FPIN0053	INCISAL PIN
27	UN	1	CMES1537	INCISAL TABLE STANDARD (POLYCARBONATE)
28	UN	1	FHST0058	CONDYLE ELEMENT SHAFT
29	UN	1	SCRE0078	INCISAL TABLE SCREW
30	UN	1	SCRE0082	MOUNTING PLATE SCREW (LOWER)
31	UN	2	FPIN0744	STABILIZING ELASTIC BAND PIN

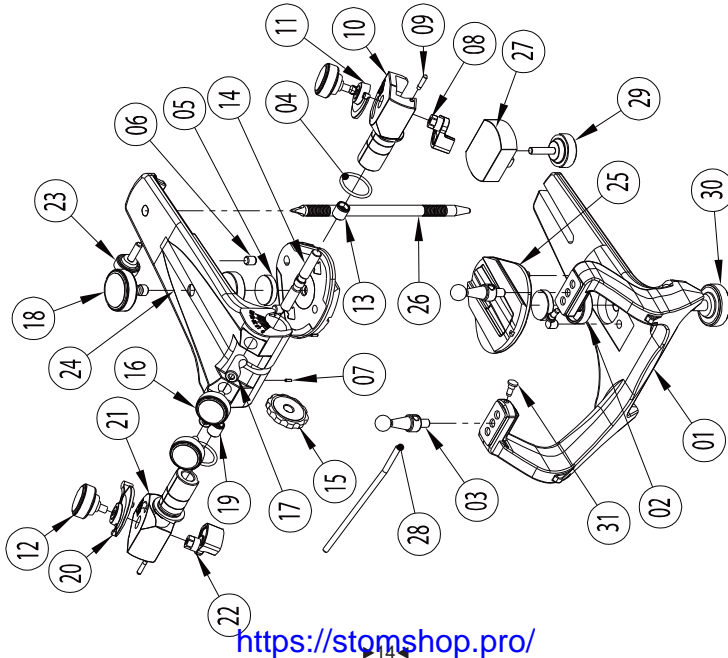

11 - PART LIST - ARTICULATOR A7 PLUS

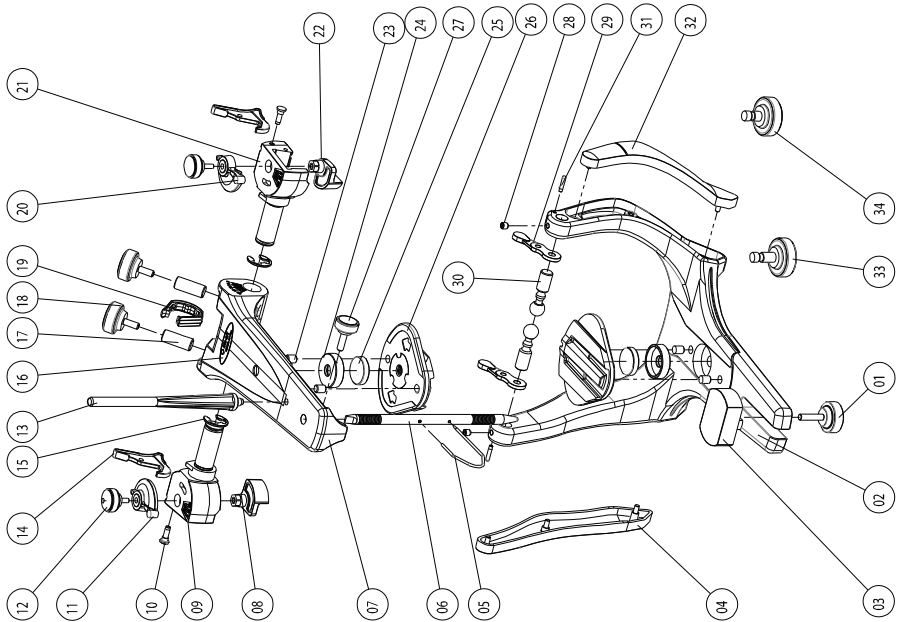

Item	Qty	Code	Description
1	1	SCRE0078	INCISAL TABLE SCREW
2	1	FRAM0731	LOWER FRAME A7
3	1	FIMES0063	INCISAL TABLE STANDARD (POLYCARBONATE)
4	1	FTAP0761	FINISHING COVER OF RIGHT COLUMN
5	1	FAGU0753	OCCUSAL PLAN INDICATOR
6	1	FRIN0750	INCISAL PIN WITH HOLE
7	1	FRAM0740	UPPER FRAME A7 PLUS
8	1	SALH0075	BENNETT ANGLE ADJUSTING DEVICE (RIGHT)
9	1	SGUI0073	CONDYLAR GUIDE (RIGHT)
10	2	FRIN0744	STABILIZING SILICONE BAND PIN
11	1	FPOS0759	POSITION INDICATOR OF BENNETT ANGLE ADJUSTING DEVICE (RIGHT)
12	2	SCRE0089	SCREW TO FIX THE BENNETT ANGLE ADJUSTING DEVICE
13	1	CPIN1197	UPPER FRAME SUPPORT PIN
14	2	FTRA0765	LOCK OF UPPER FRAME
15	2	CANE0319	CONDYLAR GUIDE O-RING
16	1	CETQ1113	MODEL IDENTIFICATION LABEL
17	2	FFX0766	CONDYLAR GUIDE FIXER
18	2	SCRE0008	CONDYLAR GUIDE SCREW
19	1	FTAP0764	PULLEY FINISHING COVER
20	1	FPOS0758	POSITION INDICATOR OF BENNETT ANGLE ADJUSTING DEVICE (LEFT)
21	1	SGUI0072	CONDYLAR GUIDE (LEFT)
22	1	SALH0074	BENNETT ANGLE ADJUSTING DEVICE (LEFT)
23	4	FPG0076	MOUNTING PLATE GUIDE PIN
24	2	FCA0755	MAGNETIC FITTING
25	2	CIMA1118	RAIL MOUNTING PLATE MAGNETIC
26	2	SPLA0079	RAIL MOUNTING PLATE
27	1	SCRE0011	CONDYLAR PIN SCREW
28	2	CPAR1119	CONDYLAR ELEMENT SCREW
29	2	CMOL1100	STABILIZING SILICONE BAND
30	2	FEC00734	CONDYLAR ELEMENT
31	2	FPG0788	FACE BOW'S GUIDE PIN
32	1	FTAP0760	FINISHING COVER OF LEFT COLUMN
33	1	SCRE0082	MOUNTING PLATE SCREW (LOWER FRAME)
34	1	SCRE0010	MOUNTING PLATE SCREW (UPPER FRAME)

COMMENTS:

*STANDARDIZED ARTICULATORS COME WITH ONLY 1 SCREW.

**MAGNETIC PLATES ARE NOT COMPATIBLE WITH THE STANDARDIZED ARTICULATOR.

12-PART LIST - ARTICULATOR A7 FIX

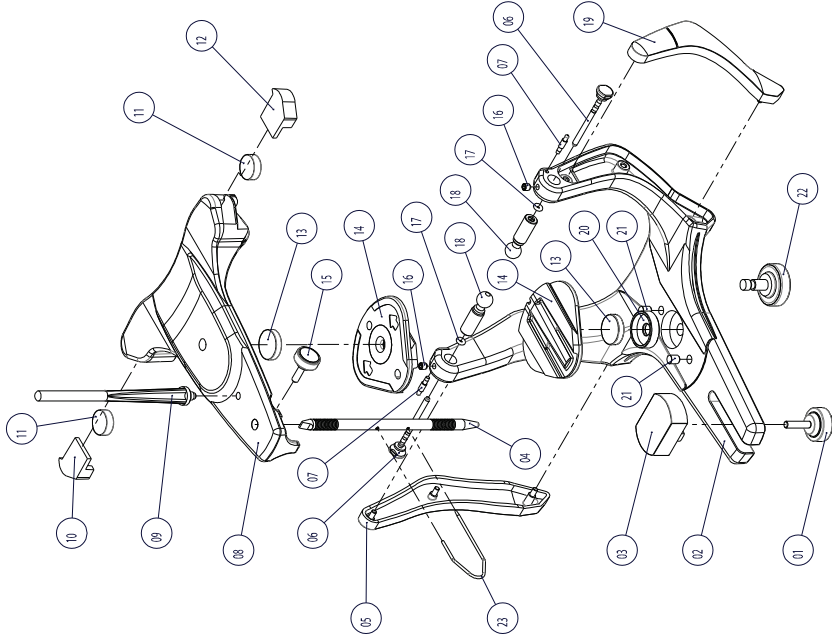

Item	Qty	Code	Description
1	1	SCRE0078	INCISAL TABLE SCREW
2	1	FRAM0731	LOWER FRAME A7
3	1	FMES0063	INCISAL TABLE STANDARD (POLYCARBONATE)
4	1	FFIN0750	INCISAL PIN WITH HOLE
5	1	FTAP0761	FINISHING COVER OF RIGHT COLUMN
6	2	FFIN0756	LOCK PIN OF CENTRIC POSITION (ARTICULATOR)
7	2	FFIG0779	FACE BOW'S GUIDE PIN
8	1	SPAN0080	UPPER FRAME
9	1	CPIN1197	UPPER FRAME SUPPORT PIN
10	1	FTAP0777	MAGNET FINISHING COVER (RIGHT)
11	2	CIMA1111	STABILIZER MAGNET
12	1	FTAP0778	MAGNET FINISHING COVER (LEFT)
13	2	CIMA1118	MOUNTING PLATE MAGNET
14	2	SPLA0079	RAIL MOUNTING PLATE
15	1	SCRE0011	INCISAL PIN SCREW
16	2	CPAR1119	CONDYLAR ELEMENT SCREW
17	2	COR11112	O-RING OF LOCK PIN
18	2	FEC00752	CONDYLAR ELEMENT
19	1	FTAP0760	FINISHING COVER OF LEFT COLUMN
20	2	FCAN0755	MAGNETIC FITTING
21	2	FFIG0076	MOUNTING PLATE GUIDE PIN
22	2	SCRE0082	MOUNTING PLATE SCREW
23	1	FAGU0753	OCCUSAL PLAN INDICATOR

COMMENTS:

*STANDARDIZED ARTICULATORS COME WITH ONLY 1 SCREW.

**MAGNETIC PLATES ARE NOT COMPATIBLE WITH THE STANDARDIZED ARTICULATOR.

13 - PART LIST - STANDARD FACE-BOW

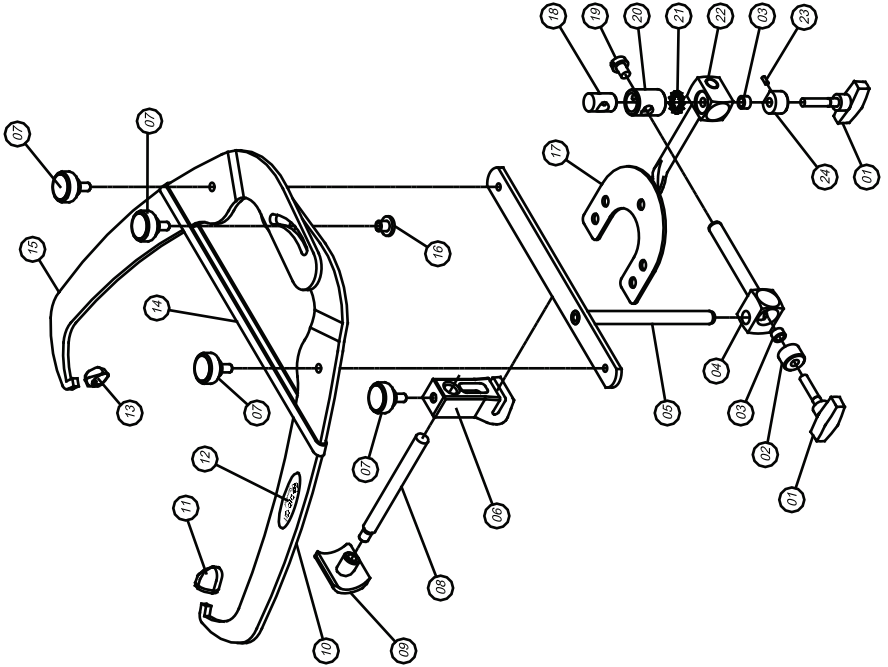

Item	Qt	Code	Description
1	2	SBBL0001	Wing screw
2	1	FFIX0362	Piece to fix the cross bar (without hole)
3	2	FMOL0025	Elastic washer
4	1	SEXP0006	Horizontal slide bar
5	1	STAR0005	Cross bar
6	1	FPNZ0020	Nose piece support
7	4	SCRE0020	Face-bow wing screw
8	1	FHST0018	Nose piece shaft
9	1	FBL00016	Nose piece
10	1	FARC0784	Face-bow arm (Right)
11	1	FAUR0033	Ear piece (Right)
12	1	CETQ0018	Model identification label
13	1	FAUR0032	Ear piece (Left)
14	1	CELA0009	Elastic band
15	1	FARC0785	Face-bow arm (Left)
16	1	FPOR0039	Center nut
17	1	SGDE0007	Bite fork
18	1	FBL00008	Connection Block (internal)
19	2	FTMP0027	Stopping screw
20	1	FBL00006	Connection block (external)
21	1	CARR0004	Washer for the block
22	1	FBL00026	Fork's connection block
23	1	CPIE0005	Affixing block pin
24	1	FFIX0022	Affixing block (with hole)

14 – SYMBOLS

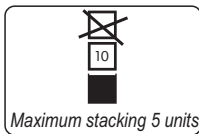
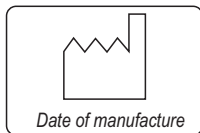
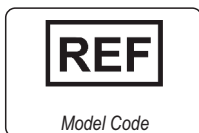

BIO-ART EQUIPAMENTOS ODONTOLÓGICOS LTDA.

Rua Teotônio Vilela, 120 - Jd. Tangará - 13568-000 - São Carlos - SP - Brasil
Tel. (16) 3371-6502 - MS: 103682-4 - instagram: bioart_solucoes_inteligentes
www.bioart.com.br - facebook.com/bioartequipamentos - bioart@bioart.com.br

<https://stomshop.pro/>