



FD251R

Mikro-Federschere
gebogen, spitz/spitz
Micro scissors (spring type),
curved, sharp/sharp
180 mm, 7"



FD252R

Mikro-Fadenschere, gebogen, spitz/spitz,
ein Blatt gezahnt, für Fäden von 6/0 – 8/0
Micro ligature scissors, curved, sharp/sharp,
one blade serrated, for suture material 6/0 – 8/0
180 mm, 7"

MIKROCHIRURGISCHES GRUNDINSTRUMENTARIUM
MICROSURGICAL BASIC SET



1/1

FD253R

Anatomische
Mikro-Pinzette
Micro dissecting
forceps

1/1 180 mm, 7"



1/1

FD255R



1/1

FD256R

FD255R-FD256R

Chirurgische
Mikro-Pinzette
Micro tissue
forceps

1/1 180 mm, 7"



1/1

COOLEY

DX303R

Atraumatische
Mikro-Pinzette
Atraumatic
micro forceps

1/1 180 mm, 7"



1/1

FD258R



1/1

FD259R

FD258R-FD259R

Mikro-Nadelhalter für
Nahtmaterial von 6/0-8/0
Micro needle holder for
suture material 6/0-8/0

1/1 180 mm, 7"



The New Class of Excellence

ERGOPERIO PINZETTEN ERGOPERIO FORCEPS



- Die runde Griffform ermöglicht das Drehen des Instruments in den Fingerspitzen
- Austarierte Instrumente mit mittigem Schwerpunkt
- The round handle enables the rotation of the instruments with the tips of the fingers
- Well balanced instruments with a centric balance point



Parallel schließende
Arbeitsenden

Parallel closing
working tips



Gerade und gebogene
Arbeitsenden

Straight and curved
working tips



ERGOPERIO PINZETTEN
ERGOPERIO FORCEPS



DX060R
anatomisch, gerade
dissecting, straight
180 mm, 7"



DX061R
anatomisch, gebogen
dissecting, curved
175 mm, 6¾"





DX070R
atraumatisch, gerade
atraumata, straight
180 mm, 7"

1/1



DX071R
atraumatisch, gebogen
atraumata, curved
175 mm, 6 3/4"

1/1



ERGOPERIO PINZETTEN
ERGOPERIO FORCEPS



DX080R
chirurgisch, gerade
surgical, straight
180 mm, 7"



DX081R
chirurgisch, gebogen
surgical, curved
175 mm, 6¾"



ZAHNÄRZTLICHE CHIRURGIE
DENTAL SURGERY

stainless
steel

steril
sterile



1/1

BA364

Mikroskalpell mit
Kunststoffgriff

Bestelleinheit:

PAK = Packung à 5 Stück

Micro scalpel with plastic
handle

Sales Unit:

PAK = Package of 5 pieces

165 mm, 6 1/2"



1/1

BA365

Mikroskalpell mit
Kunststoffgriff

Bestelleinheit:

PAK = Packung à 5 Stück

Micro scalpel with plastic
handle

Sales Unit:

PAK = Package of 5 pieces

165 mm, 6 1/2"



1/1

BA367

Mikroskalpell mit
Kunststoffgriff

Bestelleinheit:

PAK = Packung à 5 Stück

Micro scalpel with plastic
handle

Sales Unit:

PAK = Package of 5 pieces

165 mm, 6 1/2"

MIKRO-SKALPELLE, MIKRO-SKALPELLGRIFF, MIKROCHIRURGISCHE KLINGEN
 MICRO SCALPELS, MICRO SCALPEL HANDLE, MICROSURGERY BLADES

stainless steel steril sterile



BB045T

Titan-Mikroklingenhalter mit Rundgriff. Leicht, drehbar und handlich für eine exakte Schnitfführung

Titanium scalpel handle for microsurgery blades, round handle. Light, rotatable and handy for precise cutting

145 mm, 5 3/4"



BB361R

Mikrochirurgische Klinge

Bestelleinheit: PAK =
Packung à 10 Stück

Microsurgery blade

Sales unit: PAK =
Package of 10 piece



BB362R

Mikrochirurgische Klinge

Bestelleinheit: PAK =
Packung à 10 Stück

Microsurgery blade

Sales unit: PAK =
Package of 10 piece



BB363R

Mikrochirurgische Klinge

Bestelleinheit: ST =
Packung à 1 Stück

Microsurgery blade

Sales unit: ST =
Package of 1 piece



BB364R

Mikrochirurgische Klinge

Bestelleinheit: PAK =
Packung à 10 Stück

Microsurgery blade

Sales unit: PAK =
Package of 10 pieces



BB365R

Mikrochirurgische Klinge

Bestelleinheit: PAK =
Packung à 10 Stück

Microsurgery blade

Sales unit: PAK =
Package of 10 pieces



BB367R

Mikrochirurgische Klinge

Bestelleinheit: PAK =
Packung à 10 Stück

Microsurgery blade

Sales unit: PAK =
Package of 10 pieces



BB368R

Mikrochirurgische Klinge

Bestelleinheit: PAK =
Packung à 10 Stück

Microsurgery blade

Sales unit: PAK =
Package of 10 pieces



BB369R

Mikrochirurgische Klinge

Bestelleinheit: ST =
Packung à 1 Stück

Microsurgery blade

Sales unit: ST =
Package of 1 piece



ZAHNÄRZTLICHE CHIRURGIE

DENTAL SURGERY

Skalpellgriffe für sterile Skalpellklingen
 BB510 - BB515, BB540, BB542

Scalpel handles for sterile scalpel blades
 BB510 - BB515, BB540, BB542



vakuum-vergütet
 heat-treated in vacuum

steril
 sterile



BB073R

No. 3
 125 mm, 5"

BB063R

145 mm, 5 3/4"

BB077R

No. 7
 160 mm, 6 1/4"



BB510



BB511



BB512



BB542

doppelschneidig
 double cutting



BB513



BB515



BB515-C



BB540

doppelschneidig
 double cutting

BB510 - BB542

Skalpellklingen
 Bestelleinheit: PAK = Packung à 100 Stück

Scalpel blades
 Sales unit: PAK = Package of 100 pieces

SKALPELLGRIFFE, STERILE SKALPELLKLINGEN
SCALPEL HANDLES, STERILE SCALPEL BLADES

Skalpellgriffe für sterile Skalpellklingen
BB518 - BB536

Scalpel handles for sterile scalpel blades
BB518 - BB536



vakuum-vergütet
heat-treated in
vacuum



BB084R

No. 4
135 mm, 5 1/4"



BB088R

No. 8
140 mm, 5 1/2"



BB089R

145 mm, 5 3/4"



BB518



BB519



BB520



BB521



BB522



BB523



BB524



BB525



BB536

Skalpellklingen

Bestellereinheit: PAK = Packung à 100 Stück

Scalpel blades

Sales unit: PAK = Package of 100 pieces





- Konstruiert nach den Anforderungen der TRBA 250 4.2.4.
- Verhindert Infektionsübertragungen während der OP in Folge von Schnitt- und Stichverletzungen beim Anreichen, Abnehmen und Entsorgen
- Sachgemäße Verriegelung in der Entsorgungsposition
- Designed to comply with TRBA 250
- Prevention of infections caused by cuts and stab wounds suffered during hand-over, take-over and disposal of scalpels
- Blade can be locked in safe disposal position



BA810SU

Fig. 10



BA811SU

Fig. 11



BA812SU

Fig. 12



BA813SU

Fig. 13



BA815SU

Fig. 15

BA810SU – BA836SU

Sicherheitskalpelle

Bestelleinheit: PAK = Packung à 10 Stück

Safety scalpels

Sales unit: PAK = Package of 10 pieces



SICHERHEITSSKALPELLE
SAFETY SCALPELS



BA815-1SU

Fig. 15-1



BA815-CSU

Fig. 15-C



BA818SU

Fig. 18



BA819SU

Fig. 19



BA820SU

Fig. 20



BA821SU

Fig. 21



BA822SU

Fig. 22



BA823SU

Fig. 23



BA824SU

Fig. 24



BA825SU

Fig. 25



BA836SU

Fig. 36





BA210
Fig. 10



BA211
Fig. 11



BA212
Fig. 12



BA215
Fig. 15



BA215-C
Fig. 15-C



BA218
Fig. 18



BA219
Fig. 19



BA220
Fig. 20



BA221
Fig. 21



BA222
Fig. 22



BA223
Fig. 23



BA224
Fig. 24

BA210 – BA224

Sterilskalpelle mit Kunststoffheft und Klingenschutz
Bestelleinheit: PAK = Packung à 10 Stück

Sterile scalpels with plastic handle and blade protector
Sales unit: PAK = Package of 10 pieces



STERILSKALPELLE MIT KUNSTSTOFFHEFT UND KLINGENSCHUTZ, MUNDSPERRER
 STERILE SCALPELS WITH PLASTIC HANDLE AND BLADE PROTECTOR, MOUTH GAGS



HEISTER
OM030R
 Mundsperrer
 Mouth gag
 130 mm, 5 1/8"



DOYEN-JANSEN
OM041R
 Mundsperrer
 Mouth gag
 140 mm, 5 1/2"



DOYEN-COLLIN
OM040R
 Mundsperrer
 Mouth gag
 120 mm, 4 3/4"

für Kinder
 for children



MOLT
OM038R
 Mundsperrer
 Mouth gag
 100 mm, 4"



FERGUSSON-ACKLAND
OM044R
 Mundsperrer
 Mouth gag
 145 mm, 5 3/4"



OM047R
 Mundsperrer
 Mouth gag
 125 mm, 5"





ROSER-KÖNIG
OM048R
Mundsperrer
Mouth gag
160 mm, 6 1/4"



ROSER-KÖNIG
OM049R
Mundsperrer
Mouth gag
185 mm, 7 1/4"



HARTMANN
OK030R
Nasenspekulum
Nasal speculum
145 mm, 5 3/4"

MUNDSPERRER, NASENSPEKULUM, ERGOPLANT SILIKON MUNDKEILE
 MOUTH GAGS, NASAL SPECULUM, ERGOPLANT SILICONE MOUTH WEDGES



DX113 – DX115

Bestelleinheit: PAK = Packung à 2 Stück

Sales unit: PAK = Package of 2 pieces

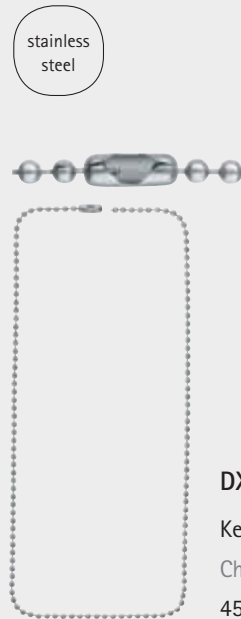

DX120R

Kette mit Klemmverschluss für DX113-DX115

Chain with clip lock for DX113-DX115
 450 mm, 17"



ERGOPLANT

DX113

Silikon-Mundkeil
 Größe: S

Silicone mouth wedge
 Size: S



ERGOPLANT

DX114

Silikon-Mundkeil mit Metallkern
 Größe: M

Silicone mouth wedge with metal core
 Size: M



ERGOPLANT

DX115

Silikon-Mundkeil mit Metallkern
 Größe: L

Silicone mouth wedge with metal core
 Size: L



ZAHNÄRZTLICHE CHIRURGIE
DENTAL SURGERY

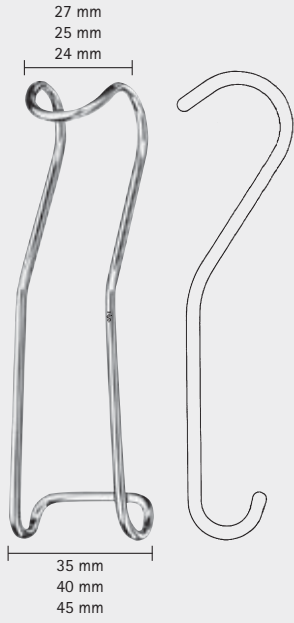

STERNBERG
OM251R - 120 mm, 4 3/4"
OM252R - 130 mm, 5 1/8"
OM253R - 135 mm, 5 1/4"
Wangen- und Lippenhalter
Cheek and lip retractor



MINNESOTA, modif.
DO010R
Wangenhalter
Cheek retractor
160 mm, 6 1/4"



DO011R
Vestibulumhaken
Vestibulum hook
140 mm, 5 1/2"



ERGOPLANT
DX101R
Vestibulumhaken
Vestibulum hook
220 mm, 8 3/4"

ZUNGEN- UND WANGENHALTER, ZUNGENSPEL, ERGOPLANT ZUNGENRETRAKTOR
 TONGUE AND CHEEK RETRACTORS, TONGUE SPATULA, ERGOPLANT TONGUE RETRACTOR



OM202R
 Zungenspatel
 Tongue spatula
 145 mm, 5 3/4"



OM203R
 Zungenspatel
 Tongue spatula
 140 mm, 5 1/2"



BUCHWALD
OM205R
 Zungenspatel
 Tongue spatula
 180 mm, 7"

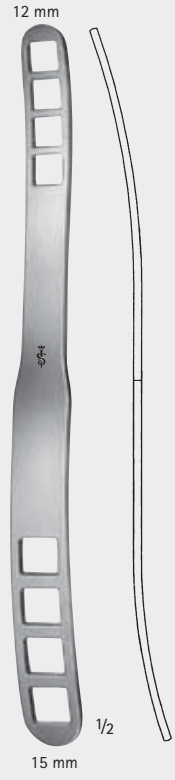

BRUENINGS
OM208R
 Zungenspatel
 Tongue spatula
 190 mm, 7 1/2"



ERGOPLANT
DX105R
 Zungenretraktor
 Tongue retractor
 190 mm, 7 1/2"





 1/1
OK520R
3.6 mm

 1/1
OK521R
4.2 mm

 1/1
OK522R
4.8 mm

110 mm, 4 1/2"

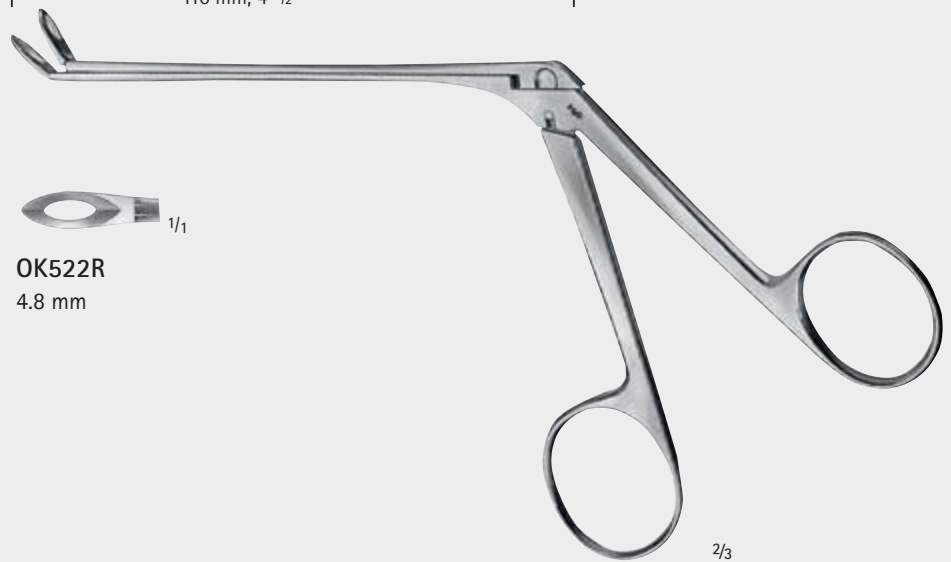

WEIL BLAKESLEY
OK520R – OK522R
Siebbeinzange, gebogen
Ethmoidal forceps, curved

SIEBBEINZANGE
ETHMOID FORCEPS



1/1

OK506R

3.6 mm



1/1

OK507R

4.2 mm



1/1

OK508R

4.8 mm



1/1

OK509R

5.6 mm

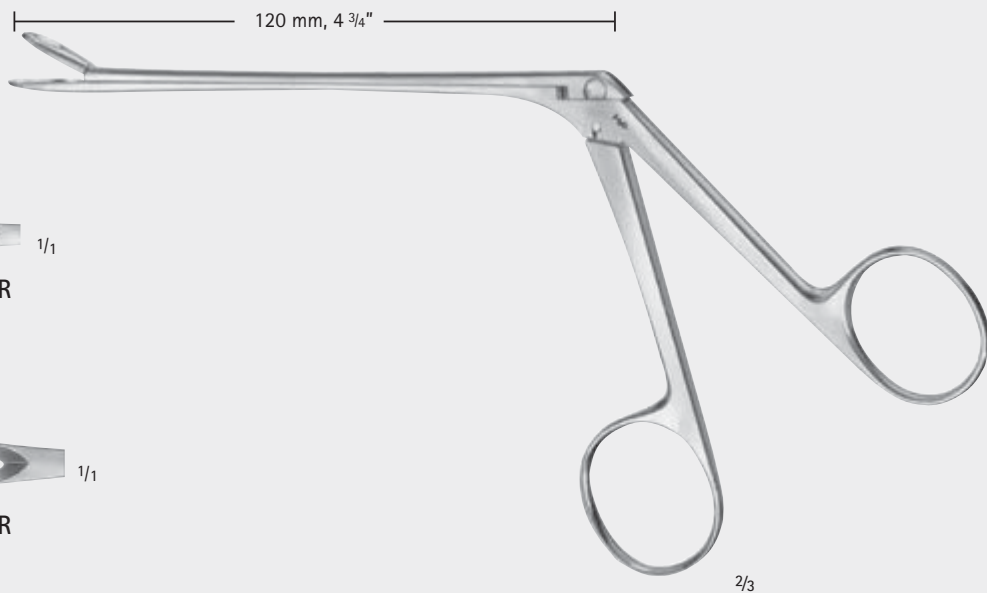

120 mm, 4 3/4"

2/3

BLAKESLEY-WILDE

OK506R – OK509R

Siebbeinzange, gerade

Ethmoidal forceps, straight



ZAHNÄRZTLICHE CHIRURGIE
DENTAL SURGERY



ERGOPLANT
DX105R
Zungenretractor
Tongue retractor
190 mm, 7 1/2"

1/2



HARTMANN
OM230R
Zungenspatel
Tongue spatula
150 mm

1/1



TOBOLD
OM235R
Zungenspatel
Tongue spatula
160 mm

1/1

ZUNGENSPEL, BAUCH- UND DARMSPATEL, HIRNSPEL
 TONGUE SPATULA, ABDOMINAL AND INTESTINAL SPATULA, BRAIN SPATULA



1/1

BT751R – BT752R

Bauch- und Darmspatel,
 biegsam

Abdominal and Intestinal
 Spatulas

	Abmessungen Dimensions
BT751R	12 x 200 mm
BT752R	17 x 200 mm



1/1

FF201R – FF202R

Hirnspele, biegsam,
 doppelt endig

Brain spatula, malleable
 double-ended

	Abmessungen Dimensions
FF201R	9 x 200 mm
FF202R	12 x 200 mm



ZAHNÄRZTLICHE CHIRURGIE
DENTAL SURGERY



ROUX

BT030R

Wangenhalter

Satz komplett, bestehend aus:
BT031R, BT032R, BT033R

Cheek retractor

Set complete, consisting of:
BT031R, BT032R, BT033R

165 mm, 6 1/2"

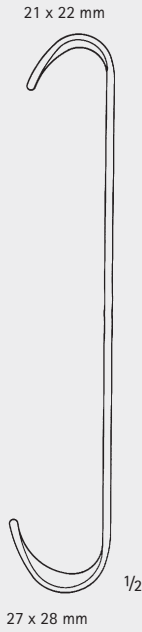

BT031R

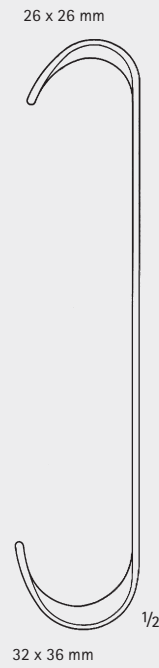

BT032R

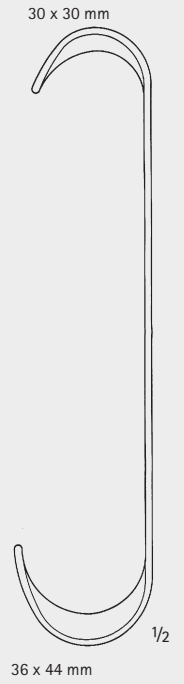

BT033R



MIDDELDORPF

BT404R – BT406R

Wangenhalter

Cheek retractor

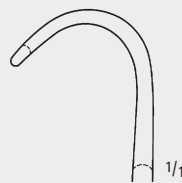

BT404R

15 x 15 mm,
220, 8 3/4"

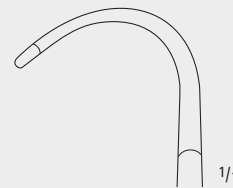

BT405R

20 x 22 mm,
215 mm, 8 1/2"

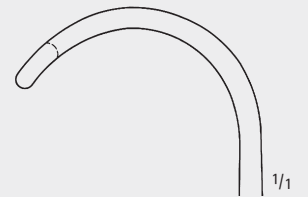

BT406R

28 x 28 mm,
235 mm, 9 1/4"

RETRAKTOREN RETRACTORS

Retraktoren für die retrograde Wurzelspitzenresektion

Beim Einsatz des Retraktors werden zunächst 2 kleine Vertiefungen in den Kieferknochen gebohrt, in welchen dann die beiden Spitzen am Instrumentenende einen zuverlässigen Halt finden.

Retractors for retrograde root resection

Before the use of the retractor, 2 slight deepenings are burred in the jaw. The 2 tips at the working end of D0373R are inserted and will therefore also provide a reliable grip.



RICHTER

D0373R

Retraktor, Blattbreite 15 mm, 45°

Retractor, width of blade 15 mm, 45°

200 mm, 8"

1/1



ZAHNÄRZTLICHE CHIRURGIE
DENTAL SURGERY



25 x 10 mm
22 x 10 mm



28 x 12 mm
32 x 12 mm

FARABEUF
BT020R
Wundhaken
Retractor
125 mm, 5"

23 x 16 mm
20 x 16 mm

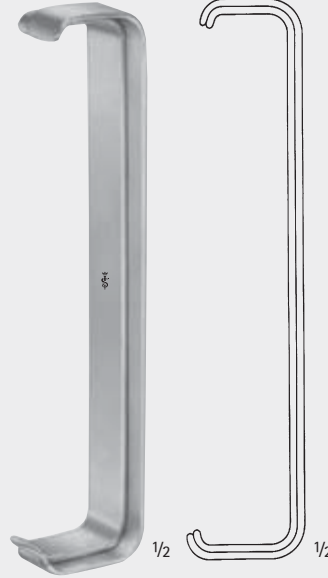

24 x 16 mm
28 x 16 mm

FARABEUF
BT021R
Wundhaken
Retractor
150 mm, 6"



LANGENBECK
BT311R - BT316R
Wundhaken
Retractor
230 mm, 9"

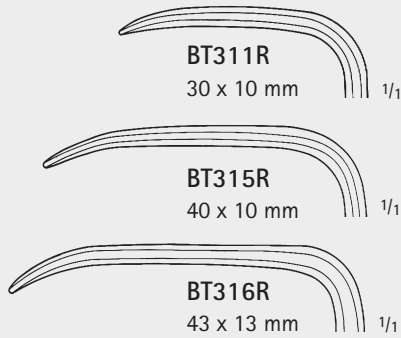

BT311R
30 x 10 mm 1/1

BT315R
40 x 10 mm 1/1

BT316R
43 x 13 mm 1/1



KOCHER-LANGENBECK
BT354R - BT361R
Wundhaken
Retractor
215 mm, 8 1/2"

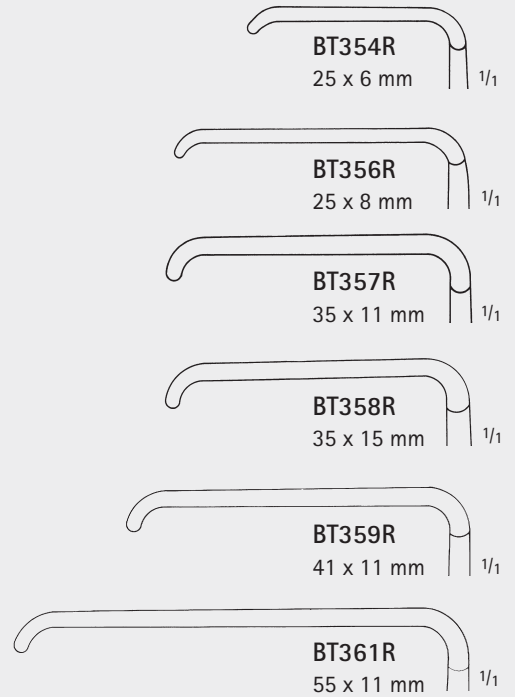

BT354R
25 x 6 mm 1/1

BT356R
25 x 8 mm 1/1

BT357R
35 x 11 mm 1/1

BT358R
35 x 15 mm 1/1

BT359R
41 x 11 mm 1/1

BT361R
55 x 11 mm 1/1

WUNDHAKEN, WANGENHALTER
RETRACTORS, CHEEK RETRACTORS



BT343R
Wangenhalter
Cheek retractor
215 mm, 8 1/2"

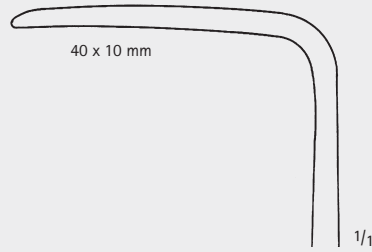

BT340R
Wundhaken
Retractor
210 mm, 8 1/4"

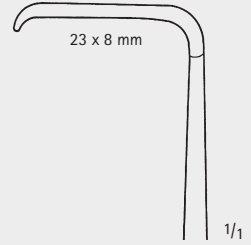

LANGENBECK
BT320R – BT326R
Wundhaken
Retractor
210 mm, 8 1/4"

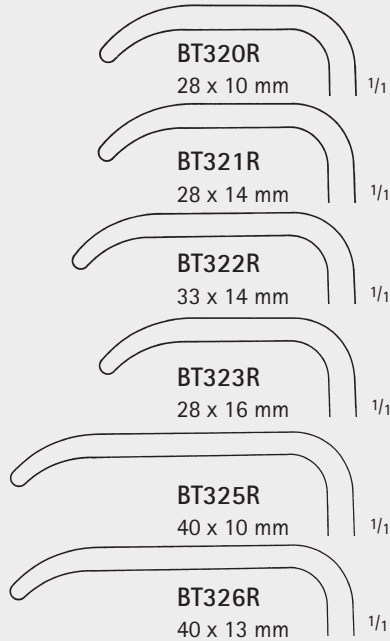

MIDDELDORPF
BT404R – BT406R
Wangenhalter
Cheek retractor

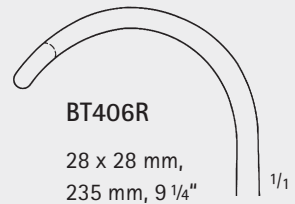

ZAHNÄRZTLICHE CHIRURGIE
DENTAL SURGERY



OBWEGESER
DO450R - DO455R
Weichteilhaken
Soft tissue retractor
215 mm, 8 1/2"



OBWEGESER
DO460R - DO465R
Weichteilhaken
Soft tissue retractor
215 mm, 8 1/2"

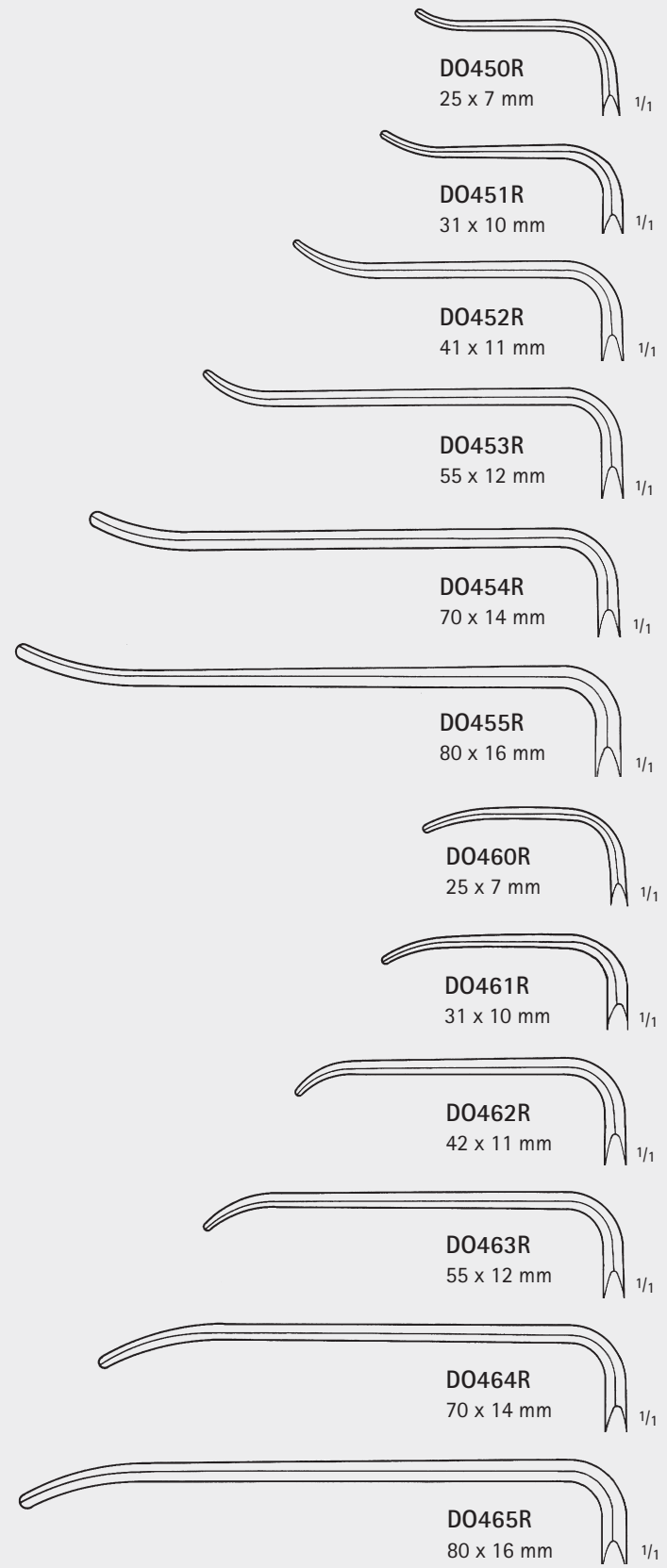

WEICHTEILHAKEN, WUNDHAKEN, WANGENHAKEN
SOFT TISSUE RETRACTORS, RETRACTORS, CHEEK RETRACTORS

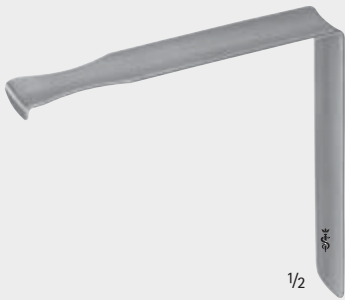

KAY (AUSTIN)
DO473R
Wundhaken
Retractor

1/2



BOWDLER-HENRY
DO470R
Wundhaken
Retractor
170 mm, 6 3/4"

1/2

Spezialhaken für obere, impaktierte Weisheitszähne. Die Griff-Form ermöglicht das Abhalten der Wange und des Mukoperiost bei gleichzeitiger Möglichkeit, ein weiteres Instrument in der selben Hand zu halten.

Especially designed for upper impacted wisdom teeth. The design of the retractor enables the retraction of the cheek and mucoperiostal flap as well as one hand simultaneous support of retractor and an additional instrument.



LASTER
DO472R
Wangenhaken
Cheek retractor
100 mm, 4"

1/2



WARD
DO471R
Wangenhaken
Cheek retractor
155 mm, 6"

1/2





38 x 18 mm

1/1

**BÜCHS
DO432R**

Wangen- und Weichteilhaken für Eingriffe im rückwärtigen Kieferbereich
Retractor for cheeks and soft tissue, for surgery in the rear maxillo-dental section
205 mm, 8"

1/2

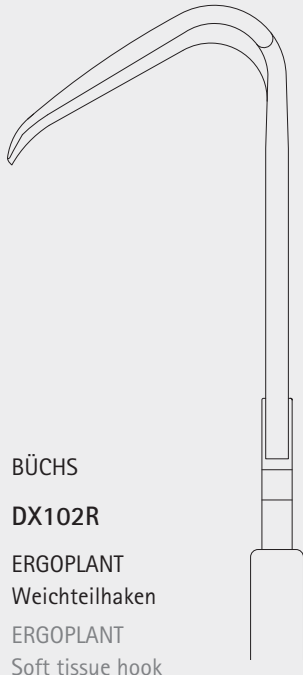

1/1

**BÜCHS
DX102R**

ERGOPLANT Weichteilhaken
ERGOPLANT Soft tissue hook
200 mm, 8"

1/2



**KIRSCH
DO440R – DO441R**

210 mm, 8 1/4"



1/1

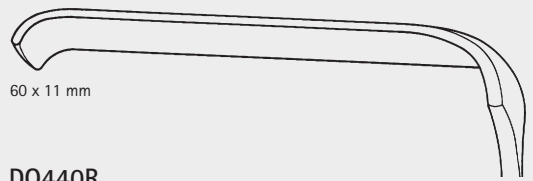

60 x 11 mm

DO440R

Mucoperiosthaken für die Weisheitszahnentfernung für rechts unten und links oben
Diagonal cheek retractors for lateral region, particularly useful for extraction of wisdom teeth for upper left and bottom right

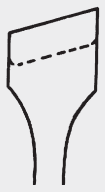

1/1

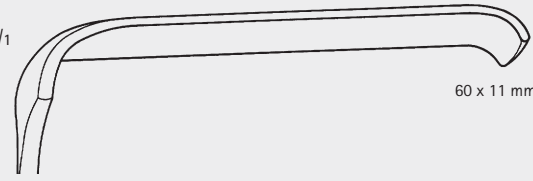

60 x 11 mm

DO441R

Mucoperiosthaken für die Weisheitszahnentfernung für rechts oben und links unten
Diagonal cheek retractors for lateral region, particularly useful for extraction of wisdom teeth for upper right and bottom left

WEICHTEILHAKEN, ERGOPLANT WEICHTEILHAKEN, MUCOPERIOSTHAKEN, WUNDHAKEN
 SOFT TISSUE RETRACTORS, ERGOPLANT SOFT TISSUE RETRACTORS, DIAGONAL CHEEK RETRACTORS, RETRACTORS

10 x 42 mm



OBWEGESER
DO407R

Spina-nasalis-Haken
 Spina-nasalis retractor
 215 mm, 8 1/2"

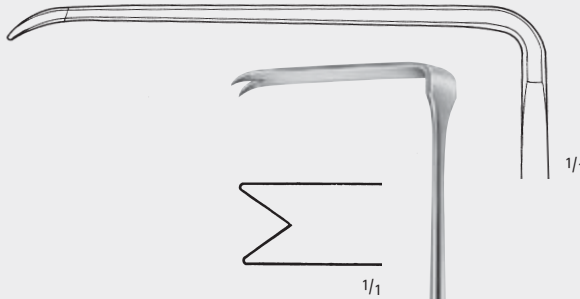

DO408R

Ramushaken zum Weghalten von Weichteilen
 Ramus retractor for separation of ramus and tissue
 220 mm, 8 3/4"

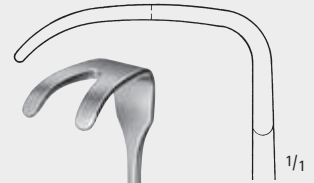

WASSMUND
DO409R

Wundhaken
 Retractor
 220 mm, 8 3/4"



breit/wide
DO420R 20 mm
DO421R 25 mm
DO422R 30 mm

DO420R - DO422R

Ramushaken
 Ramus retractor
 165 mm, 6 1/2"



DOCKHORN
DO438R - DO439R

Wundhaken
 Retractor
 210 mm, 8 1/4"



DO438R
 40 x 12 mm

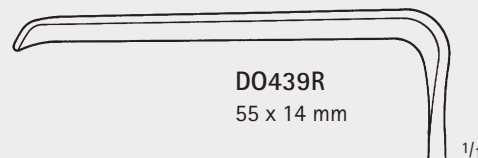

DO439R
 55 x 14 mm



ZAHNÄRZTLICHE CHIRURGIE
DENTAL SURGERY



TESSIER
DO417R
Haken zum Vorbringen
des Oberkiefers
rechts
Maxillary mobilizers
right
150 mm, 6"



TESSIER
DO418R
Haken zum Vorbringen
des Oberkiefers
links
Maxillary mobilizers
left
150 mm, 6"



OBWEGESER
DO411R 8 mm
DO412R 10 mm
Progenie-Rinne
Channeled retractor
165 mm, 6 1/2"



OBWEGESER
DO410R
Kinnhalter
Chin retractor
155 mm, 6"

WUNDHAKEN
RETRACTORS



OBWEGESER

DO447R 12 x 30 mm

DO448R 12 x 45 mm

DO449R 12 x 55 mm

Wundhaken

Retractor

200 mm, 8"

1/2



ZAHNÄRZTLICHE CHIRURGIE
DENTAL SURGERY



FRAZIER
FF321R
130 mm, 5 1/8"



GILLIES
OL611R – OL612R
180 mm, 7"



GRAEFE
OA332R – OA333R
125 mm, 5"



FREER
OL621R
150 mm, 6"

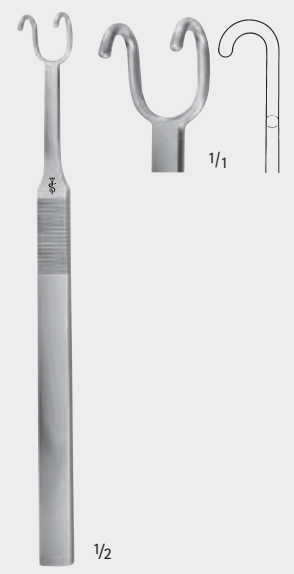

FOMON
OL202R
145 mm, 5 3/4"



BERGMANN
BT100R
140 mm, 5 1/2"



KILNER
OL610R
160 mm, 6 1/4"



JOSEPH
OL620R – OL624R
165 mm, 6 1/2"



OL622R
3 mm



OL623R
6 mm



OL624R
8 mm

WUNDHAKEN, FEINE WUNDHÄKCHEN
 RETRACTORS, FINE WOUND RETRACTORS

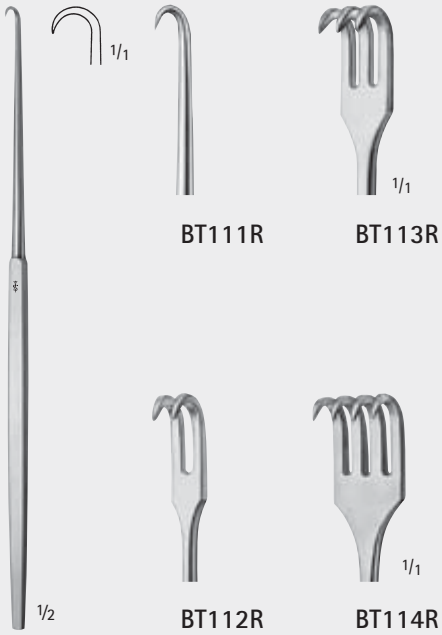

BT111R – BT114R

Enge Biegung, scharf
 Small curve, sharp
 165 mm, 6 1/2"

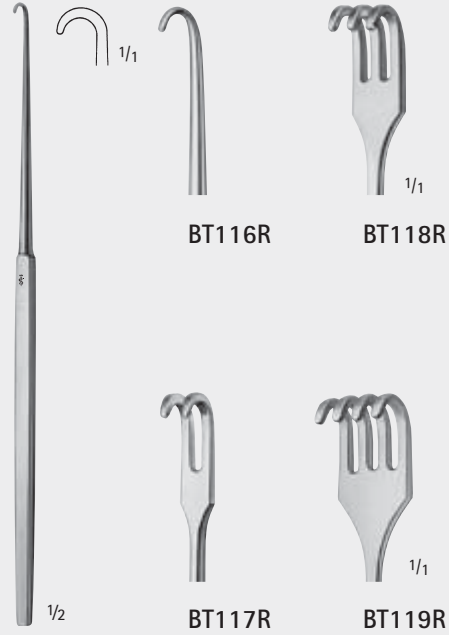

BT116R – BT119R

Enge Biegung, stumpf
 Small curve, blunt
 165 mm, 6 1/2"

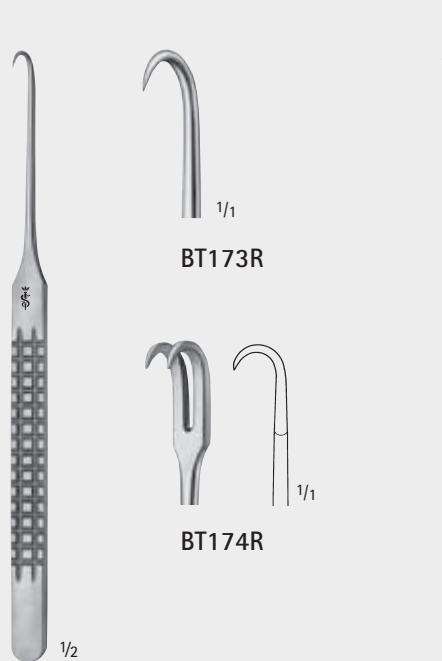

BT173R – BT174R

160 mm, 6 1/4"



LANGENBECK-GREEN

BT177R – BT178R

160 mm, 6 1/4"

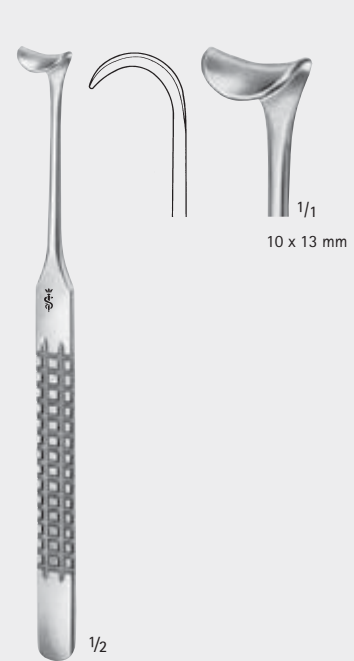

BT179R

160 mm, 6 1/4"





DO315R
Gazespender
Gauze case



LUNIATSCHEK
DO301R
Tamponstopfer
Cotton plugger
180 mm, 7"



LUNIATSCHEK, modif.
DO302R
Tamponstopfer, schmal
Cotton plugger, small
180 mm, 7"

GAZESPENDER, TAMPONSTOPFER, RETRAKTIONSINSTRUMENTE, MEDIKAMENTENTRÄGER
GAUZE CASE, COTTON PLUGGERS, RETRACTION INSTRUMENTS, MEDICINE APPLICATOR



D0303R

Retraktionsfadenstopfer,
flexibel

Retraction thread packer,
flexible

175 mm, 7"



HAUER

DB776R

Medikamententräger

Medicine applicator

135 mm, 5 1/4"



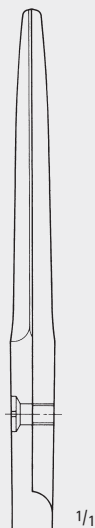

BC313R

130 mm, 5 1/8"

BC314R

145 mm, 5 3/4"

BC313R – BC314R

Standard Modelle

Standard patterns



BC411R

115 mm, 4 1/2"

BC413R

130 mm, 5 1/8"

BC414R

145 mm, 5 3/4"

COOPER

BC411R – BC414R

Standard Modelle

Standard patterns

CHIRURGISCHE SCHEREN
SURGICAL SCISSORS



BC320R

105 mm, 4 1/8"



BC321R

115 mm, 4 1/2"



BC323R

130 mm, 5 1/8"



BC324R

145 mm, 5 3/4"

BC320R – BC324R

Standard Modelle
Standard patterns



BC421R

115 mm, 4 1/2"



BC423R

130 mm, 5 1/8"



BC424R

145 mm, 5 3/4"

BC421R – BC424R

Standard Modelle
Standard patterns



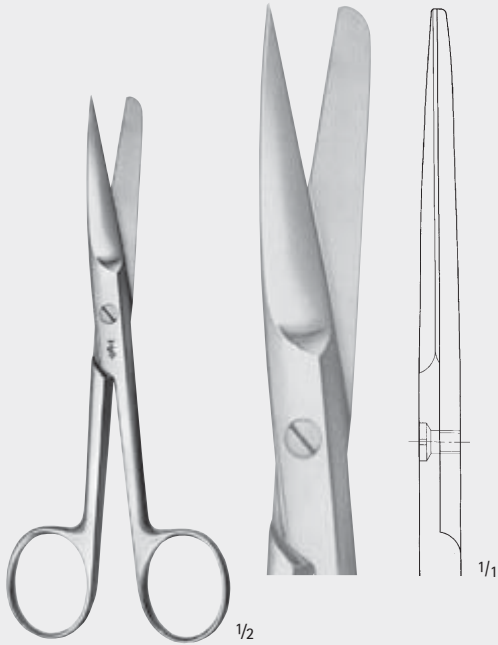

DEAVER

BC374R

Chirurgische Schere mit Flachschluss

Surgical scissors with flat lock

145 mm, 5 3/4"

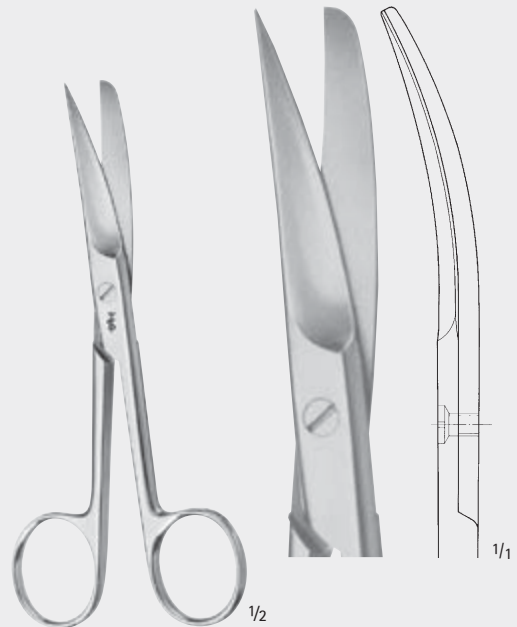

DEAVER

BC474R

Chirurgische Schere mit Flachschluss

Surgical scissors with flat lock

145 mm, 5 3/4"

CHIRURGISCHE SCHEREN, PRÄPARIERSCHEREN
SURGICAL SCISSORS, DISSECTING SCISSORS



BC164R

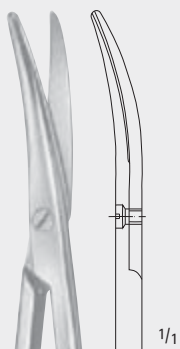

BC165R

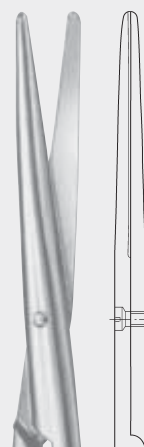

BC600R

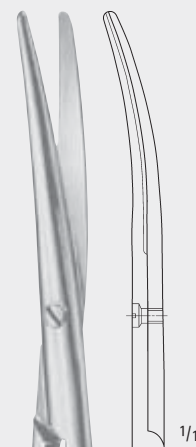

BC603R

BABY-METZENBAUM

BC600R – BC603R

Präparierschere

Dissecting scissors

145 mm, 5 3/4"

BC164R – BC165R

Präparierschere

Dissecting scissors

115 mm, 4 1/2"

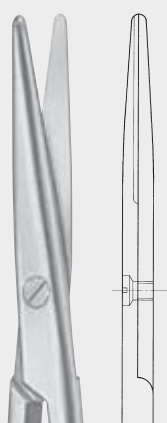

BC601R

145 mm, 5 3/4"



BC602R

180 mm, 7"

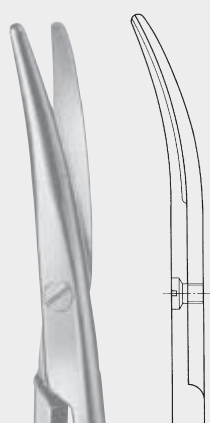

BC605R

145 mm, 5 3/4"



BC606R

180 mm, 7"

METZENBAUM

BC601R – BC606R

Präparierschere

Dissecting scissors



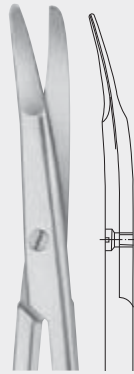

BC166R
125 mm, 5"

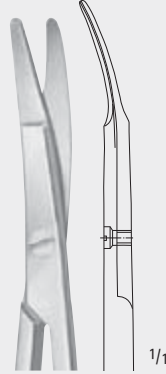

BC168R
150 mm, 6"

KILNER

BC166R – BC168R

Besonders flache Spitzen zum Präparieren
und Unterminieren der Haut

Special flat points for dissecting and
undermining the skin

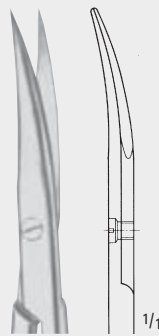

BC628R

Außenkanten der Blätter halbscharf

Blades outside semi-sharp

150 mm, 6"

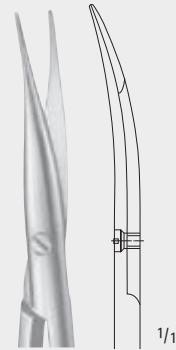

JAMESON-WERBER

BC175R

130 mm, 5 1/8"



PRÄPARIERSCHEREN
DISSECTING SCISSORS

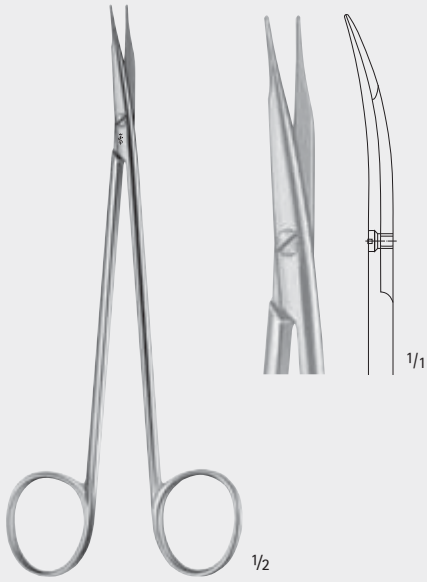

JAMESON
BC177R
150 mm, 6"

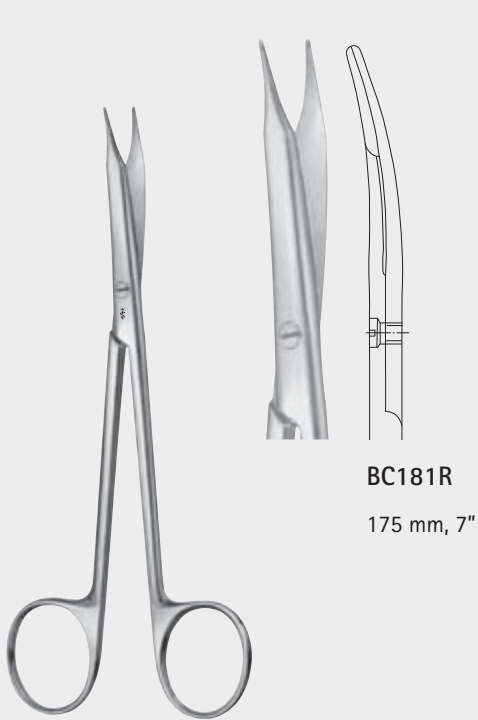

REYNOLDS
BC180R – BC181R

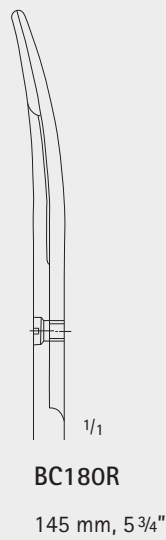

BC180R
145 mm, 5 3/4"

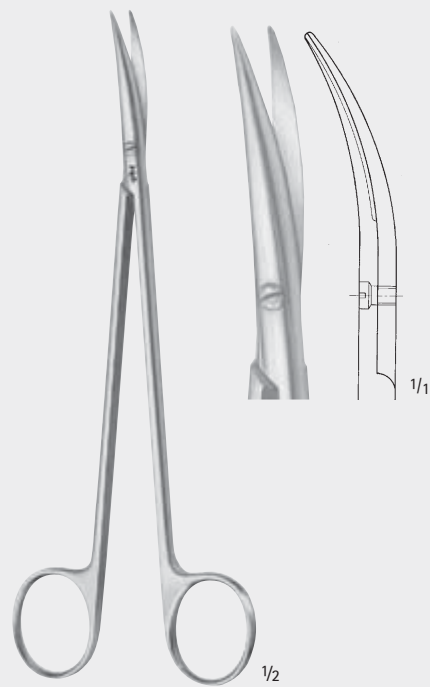

DE BAKEY
BC629R
175 mm, 7"



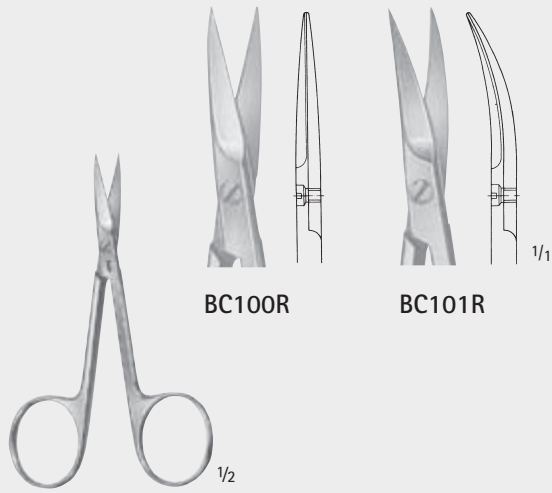

BC100R

BC101R

BC100R – BC101R

90 mm, 3 1/2"

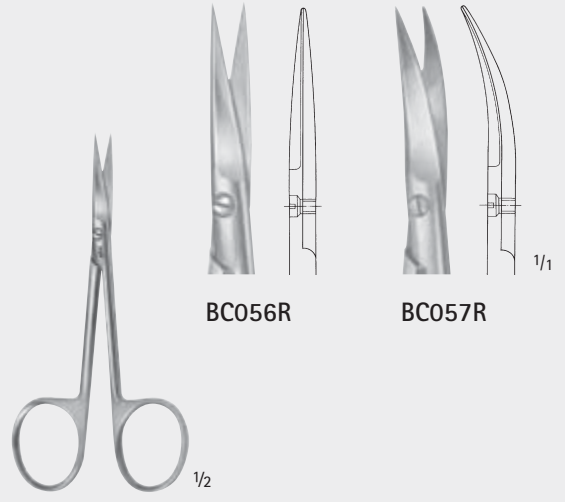

BC056R

BC057R

BC056R – BC057R

95 mm, 3 3/4"

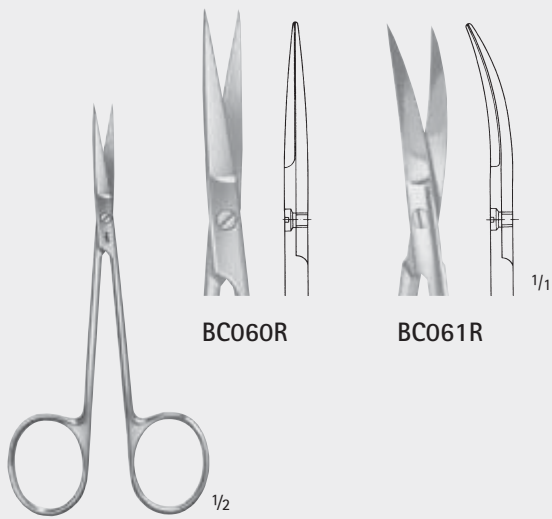

BC060R

BC061R

BC060R – BC061R

105 mm, 4 1/8"

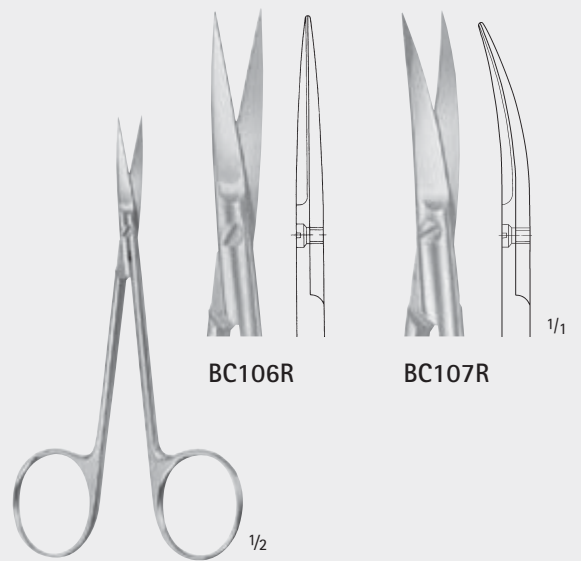

BC106R

BC107R

BC106R – BC107R

115 mm, 4 1/2"

FEINE SCHEREN
DELICATE SCISSORS

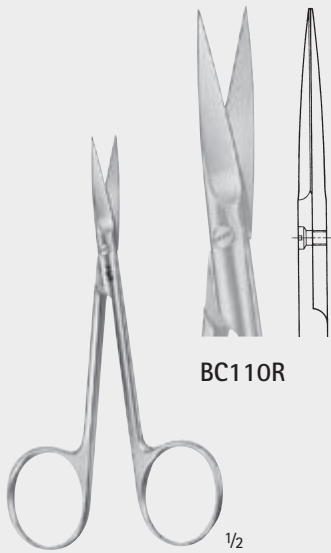

BC110R



BC111R

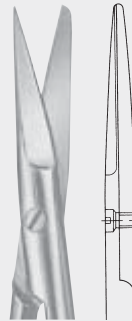

BC112R



BC113R

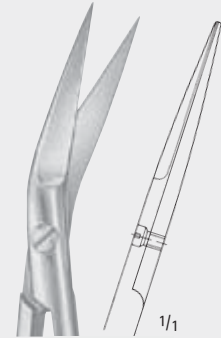

BC117R

Seitwärts gebogen,
besonders geeignet
zur Nahtentfernung

Curved to side,
especially suited to
remove ligatures

BC110R – BC117R

110 mm, 4³/₈"

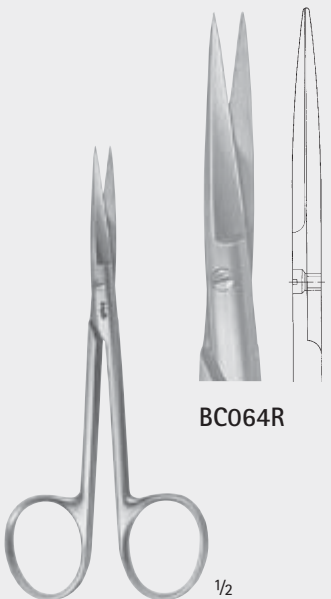

BC064R

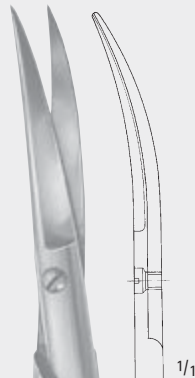

BC065R

BC064R – BC065R

120 mm, 4³/₄"



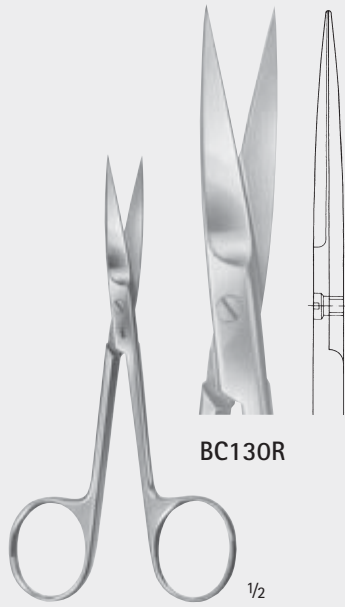

BC130R

1/2

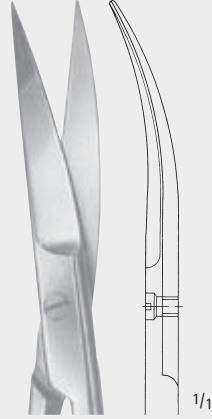

BC131R

1/1

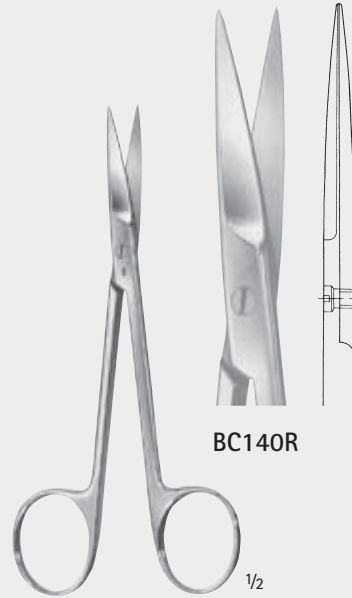

BC140R

1/2

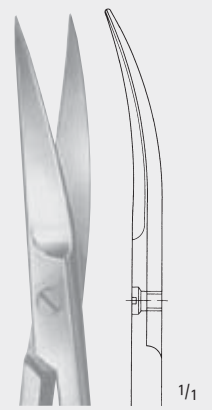

BC141R

1/1

BC130R – BC131R

120 mm, 4 3/4"

BC140R – BC141R

130 mm, 5 1/8"

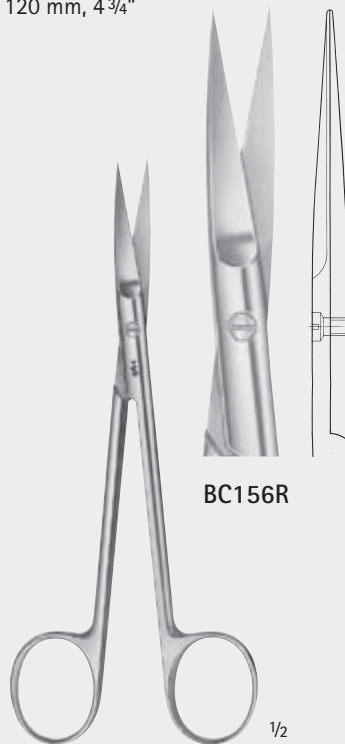

BC156R

1/2

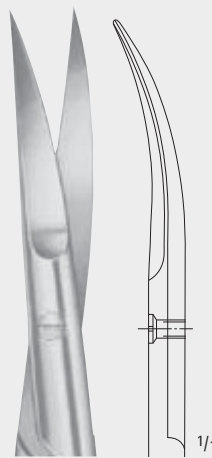

BC157R

1/1

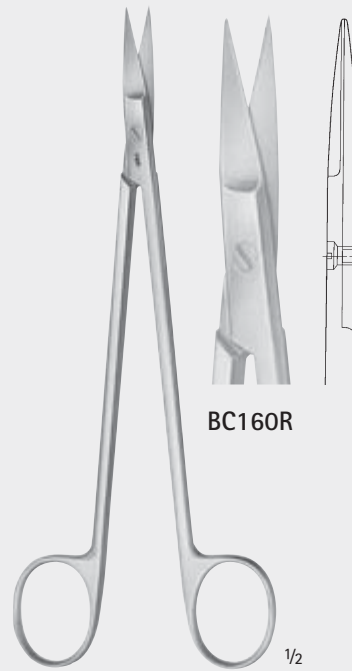

BC160R

1/2

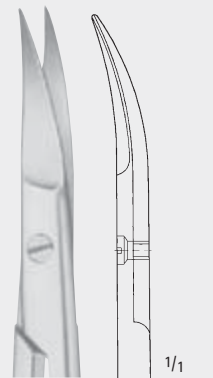

BC161R

1/1

JOSEPH

BC156R – BC157R

150 mm, 6"

KELLY

BC160R – BC161R

175 mm, 7"

FEINE SCHEREN
DELICATE SCISSORS

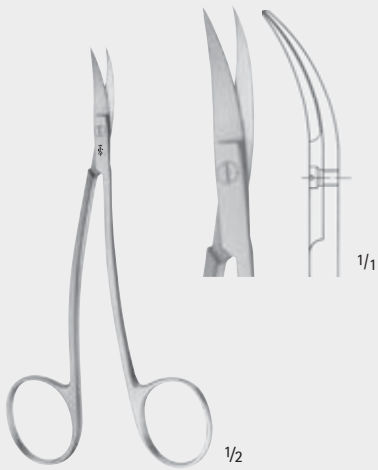

LA GRANGE

BC154R

1 Schneide gezahnt

1 Blade toothed

110 mm, 4 3/8"

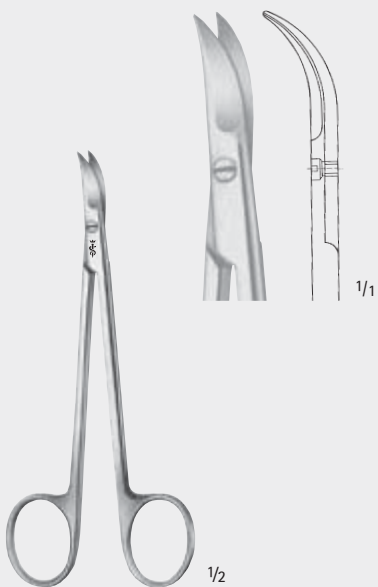

CHADWICK

BC153R

115 mm, 4 1/2"

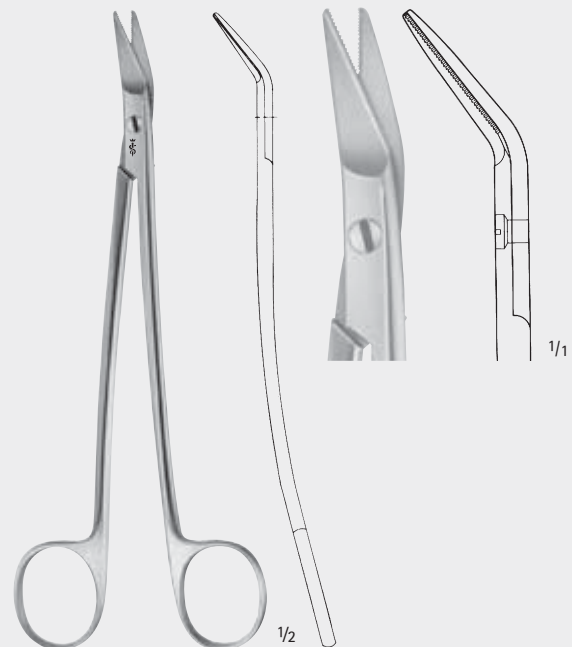

DEAN

OM700R

Schneiden gezahnt

Blades serrated

170 mm, 6 3/4"



ZAHNÄRZTLICHE CHIRURGIE
DENTAL SURGERY

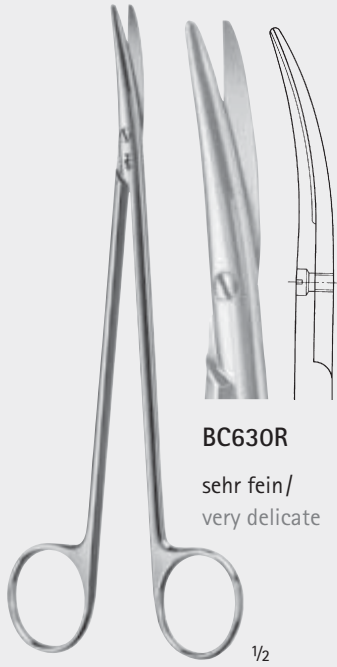

BC630R
sehr fein/
very delicate

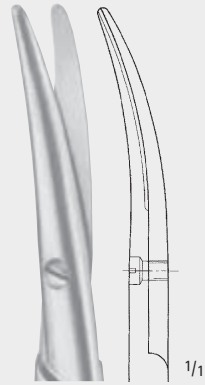

BC631R
fein/delicate

TOENNIS-ADSON

1/2

BC630R – BC631R

175 mm, 7"



OK372R
135 mm, 5 1/4"

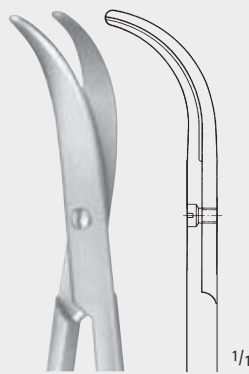

OK373R
115 mm, 4 1/2"

FOMON

OK372R – OK373R

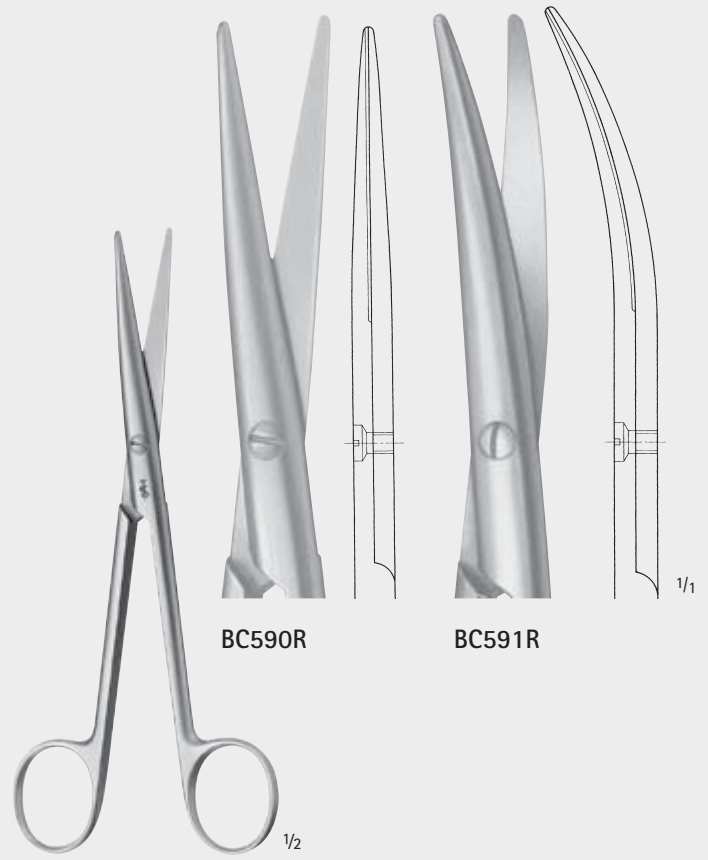

BC590R

BC591R

LEXER

BC590R – BC591R

schmal/narrow

165 mm, 6 1/2"

PRÄPARIERSCHEREN
DISSECTING SCISSORS

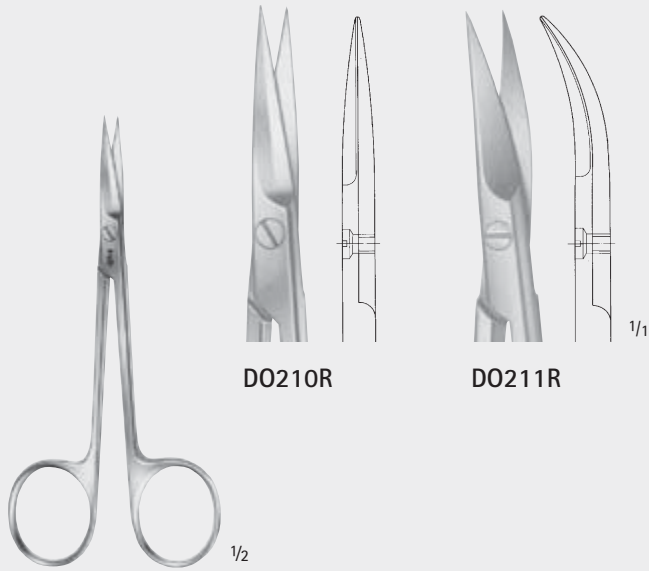

DO210R

DO211R

DO210R – DO211R

120 mm, 4 3/4"

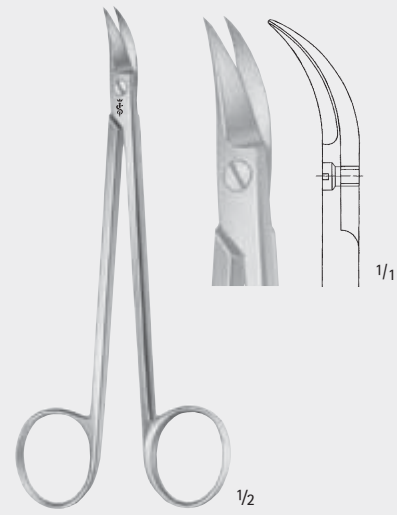

QUINBY

DO218R

130 mm, 5 1/8"

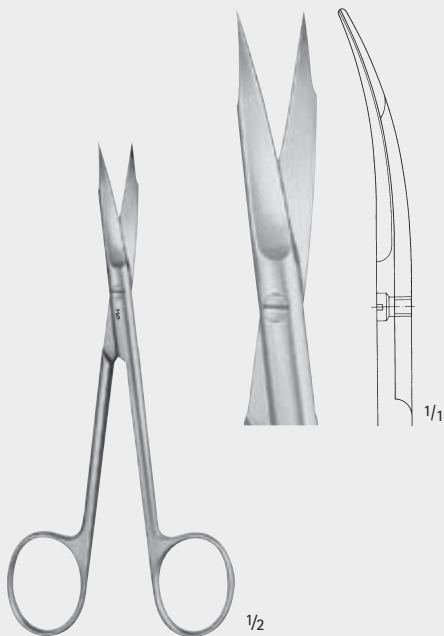

GOLDMAN-FOX

DO251R

1 Schneide fein gezahnt

1 Blade toothed, fine

130 mm, 5"



LOCKLIN

DO219R

Seitwärts abgewinkelt, 1 Schneide gezahnt

Angled to side, 1 blade toothed

155 mm, 6"





BC303R – BC304R
Schlanke Modelle
Slender patterns



BC303R
130 mm, 5 1/8"

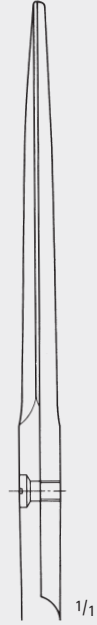

BC304R
145 mm, 5 3/4"



BC403R – BC404R
Schlanke Modelle
Slender patterns



BC403R
130 mm, 5 1/8"

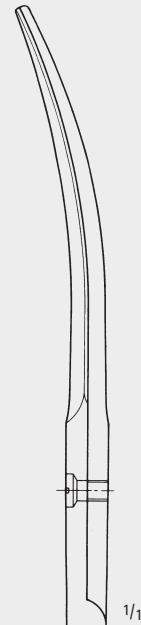

BC404R
145 mm, 5 3/4"

DUROTIP®

DUROTIP®-Scheren
 mit eingesetzten Hartmetall-Schneiden

- 3 Jahre Garantie
- Vergoldete Ringe

DUROTIP®-Scissors
 with inserted carbide cutting edges

- 3 years guarantee
- Gold-plated rings

»grazil«



DO208R

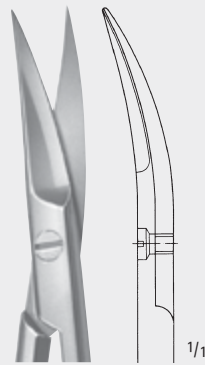

DO209R

DO208R – DO209R

120 mm, 4 3/4"

»grazil«



GOLDMAN-FOX

DO250R

1 Schneide gezahnt

1 Blade serrated

130 mm, 5 1/8"



DUROTIP®-Scheren
mit eingesetzten Hartmetall-Schneiden

- 3 Jahre Garantie
- Vergoldete Ringe

DUROTIP®-Scissors
with inserted carbide cutting edges

- 3 Years guarantee
- Gold-plated rings

Wellenschliff

~W-Cut



Artikel mit dem Zusatz ~W sind auf einer
Schnittfläche mit Wellenschliff versehen
(bei Bestellungen bitte angeben –
z.B. BC211W)

~W-Cut directly after the catalogue number
indicates that the resp. item has one serrated
cutting edge.

(When ordering please indicate ~W-cut
together with the catalogue number
e. g.: BC211W)

»grazi«



BC210R – BC211R, BC211W

110 mm, 4 3/8"

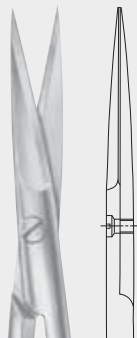

BC210R

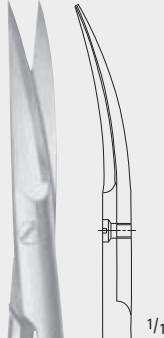

BC211R

BC211W

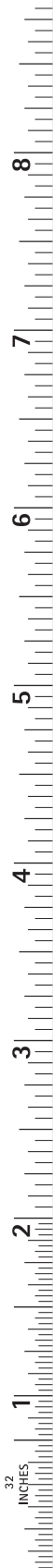

DUROTIP® FEINE SCHEREN, CHIRURGISCHE SCHEREN
 DUROTIP® DELICATE SCISSORS, SURGICAL SCISSORS



BC256R

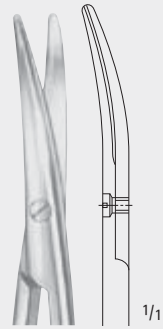

BC257R
 BC257W



BC258R

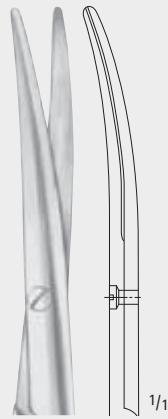

BC259R
 BC259W

BABY-METZENBAUM

BC258R – BC259R, BC259W

BC256R – BC257R, BC257W

115 mm, 4 1/2"

145 mm, 5 3/4"

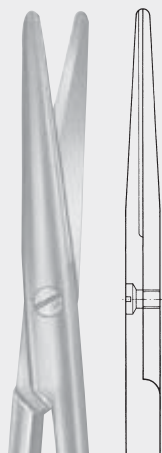

BC260R
 145 mm, 5 3/4"

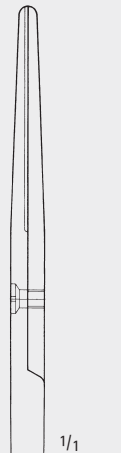

BC262R
 180 mm, 7"

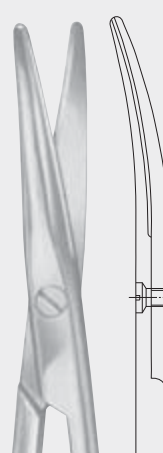

BC261R
 BC261W
 145 mm, 5 3/4"

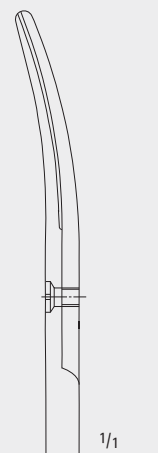

BC263R
 BC263W
 180 mm, 7"

METZENBAUM

BC260R – BC263R

BC261W, BC263W



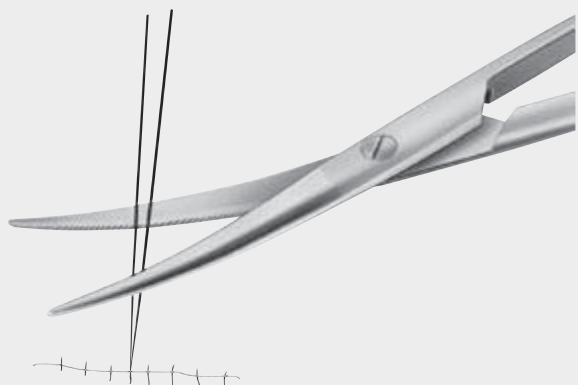

Speziell zum Schneiden von Nahtmaterial

- DUROTIP® -Ligaturscheren sind gekennzeichnet mit
- 1 vergoldeten und
- 1 schwarz gefärbten Ring

Especially for cutting suture materials

- DUROTIP® ligature scissors are identified by
- 1 black and
- 1 goldplated ring



BC294W

Ligaturschere
Ligature scissors
145 mm, 5 3/4"

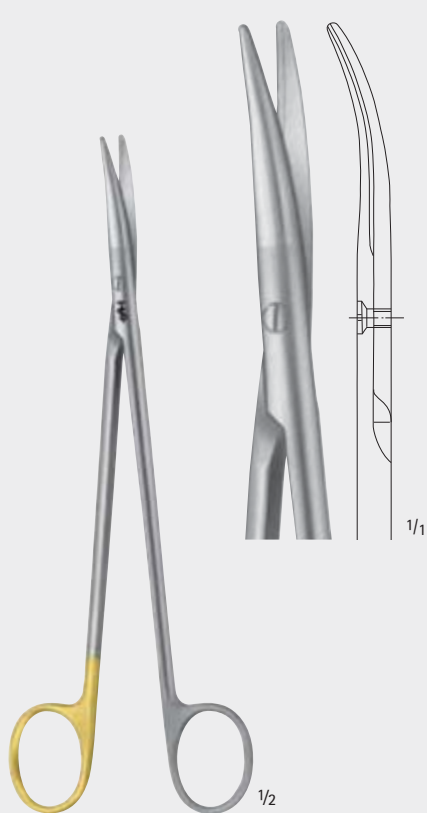

BC295W

Ligaturschere
Ligature scissors
180 mm, 7"

PRÄPARIERSCHEREN, Noir® PRÄPARIERSCHEREN
DISSECTING SCISSORS, Noir® SCISSORS

Die speziellen Eigenschaften der Noir® Präparierscheren ermöglichen ein Präparieren noch feiner und zuverlässiger als je zuvor. Noir®. Schonendes Präparieren mit minimalem Kraftaufwand.

The special qualities of the Noir® dissecting scissors allow dissection that is finer than ever before. Noir®. Gentle dissection with minimum use of force.



ZAHNÄRZTLICHE CHIRURGIE

DENTAL SURGERY

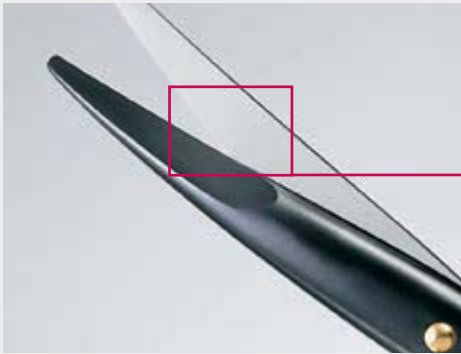

Mikrotomschliff - besonders scharfer Anschliff des Scherenblattes für sanftes durchtrennen des Gewebes bei minimalem Kraftaufwand.

Microtome edge - the extremely sharp cutting edge of the scissors blade facilitates gentle cutting of tissue with minimal use of force.



METZENBAUM

BC257WB

115 mm, 4 1/2"



BABY-METZENBAUM

BC259WB

145 mm, 5 3/4"



PRÄPARIERSCHEREN, Noir® PRÄPARIERSCHEREN
DISSECTING SCISSORS, Noir® SCISSORS

Die Verbindung der bewährten AESCULAP® Hartmetall Technologie mit der AESCULAP® Noir® Beschichtung führt zu einer extrem hohen Oberflächenhärte. Noir®. Die Präparierscheren mit der hohen Verschleißbeständigkeit im täglichen Klinikeinsatz.

The combination of the renowned AESCULAP® tungsten carbide technology with the AESCULAP® Noir® coating results in an extremely high surface hardness and therefore high wear resistance in daily hospital use.

Die extrem harte (2000HV) und reflexionsarme Noir® Beschichtung unterstützt die Verschleißfestigkeit bei gleichzeitig hoher Korrosionsbeständigkeit.

The extremely hard (2000HV) and low reflection Noir® coating leads to high wear resistance of the instruments and at the same time provides high resistance against corrosion.



METZENBAUM

BC261WB – BC275WB



ZAHNÄRZTLICHE CHIRURGIE
DENTAL SURGERY



SPENCER

BC801R – BC802R

Ligaturschere
Ligature scissors



BC801R

90 mm, 3 1/2"



BC802R

115 mm, 4 1/2"

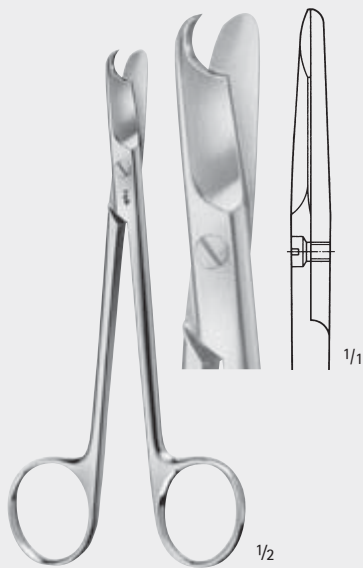

LITTAUER

BC803R

Ligaturschere
Ligature scissors
135 mm, 5 1/4"

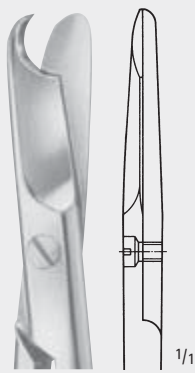

1/2

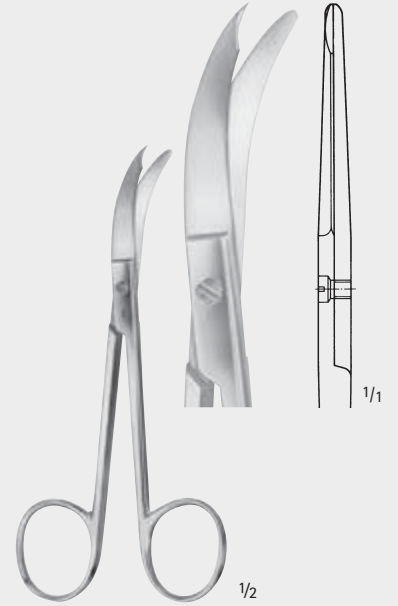

NORTHBENT

BC805R

Ligaturschere
Ligature scissors
120 mm, 4 3/4"

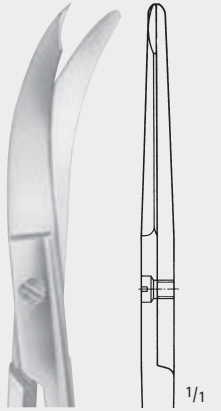

1/1



LISTER

BC860R – BC863R

Verband- und Kleiderschere
Bandage and cloth scissors

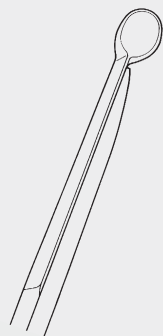

BC860R

115 mm, 4 1/2"

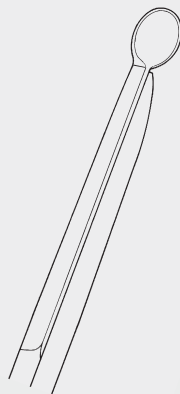

BC861R

140 mm, 5 1/2"

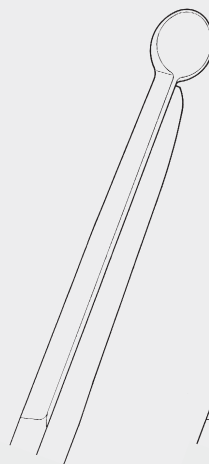

BC862R

180 mm, 7"

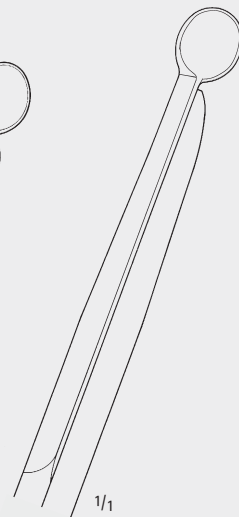

BC863R

200 mm, 8"

1/1

LIGATURSCHEREN, VERBAND- UND KLEIDERSCHEREN, ANATOMISCHE PINZETTEN
 LIGATURE SCISSORS, BANDAGE AND CLOTH SCISSORS, DISSECTING FORCEPS

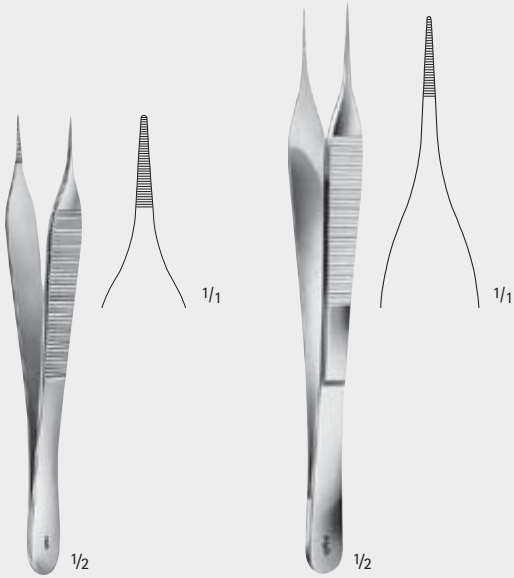

MICRO-ADSON
BD220R
 120 mm, 4 3/4"

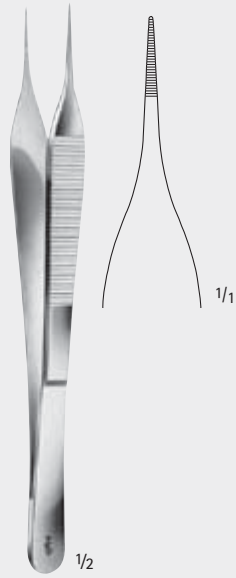

MICRO-ADSON
BD223R
 150 mm, 6"

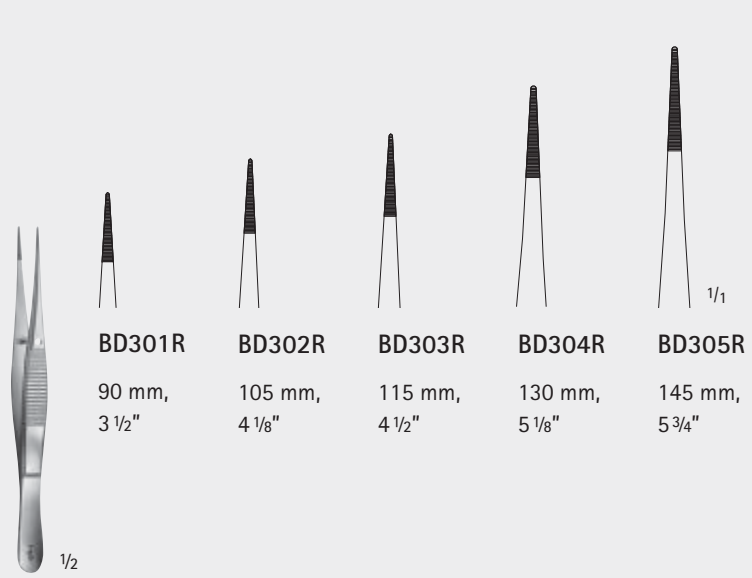

BD301R 90 mm, 3 1/2"
BD302R 105 mm, 4 1/8"
BD303R 115 mm, 4 1/2"
BD304R 130 mm, 5 1/8"
BD305R 145 mm, 5 3/4"

BD301R – BD305R

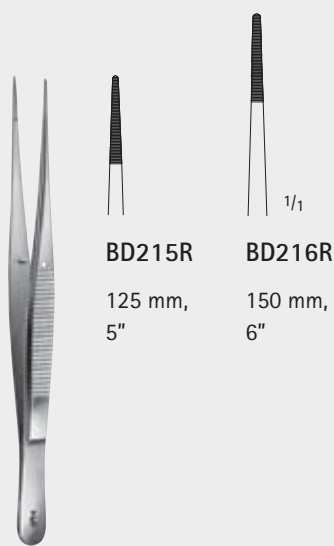

SEMKEN
BD215R – BD216R

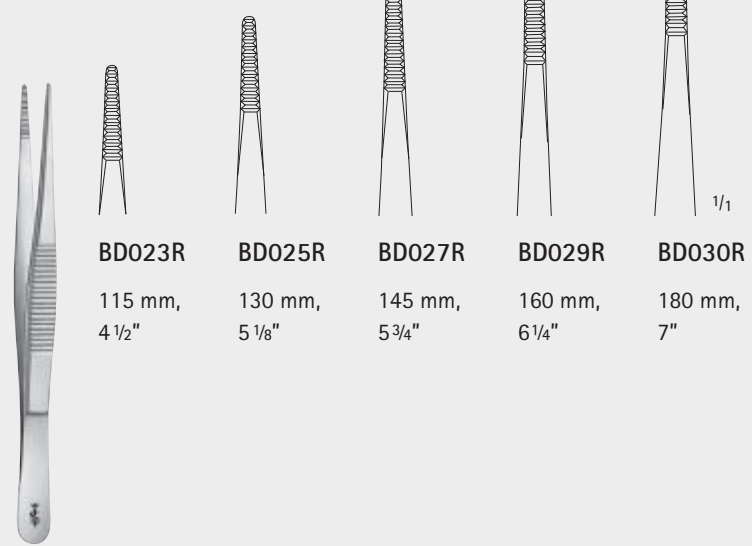

BD023R 115 mm, 4 1/2"
BD025R 130 mm, 5 1/8"
BD027R 145 mm, 5 3/4"
BD029R 160 mm, 6 1/4"
BD030R 180 mm, 7"

BD023R – BD030R





mittelbreit
 medium



ZAHNÄRZTLICHE CHIRURGIE
DENTAL SURGERY



STANDARD
BD043R – BD049R

- 
BD043R
 115 mm,
 4 1/2"
- 
BD045R
 130 mm,
 5 1/8"
- 
BD047R
 145 mm,
 5 3/4"
- 
BD049R
 160 mm,
 6 1/4"



BD217R
155 mm, 6"



DA300R
Nahtpinzette, gewinkelt
Suture forceps, angled
150 mm, 6"



DX060R
Anatomisch, gerade
Dissecting, straight
180 mm, 7"



DX061R
Anatomisch, gebogen
Dissecting, curved
175 mm, 6 3/4"



BD035R – BD037R
Mittelbreit
Medium



BD035R
130 mm,
5 1/8"

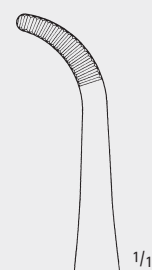

BD037R
140 mm,
5 1/2"



BROPHY
BD246R – BD247R
200 mm, 8"



BD246R

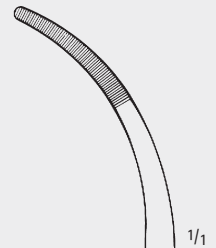

BD247R

ANATOMISCHE PINZETTEN, ATRAUMATA PINZETTEN, ERGOPLANT PINZETTEN
 DISSECTING FORCEPS, ATRAUMATA FORCEPS, ERGOPLANT FORCEPS

ATRAUMATA®

DE BAKEY Zahnung



Toothing DE BAKEY

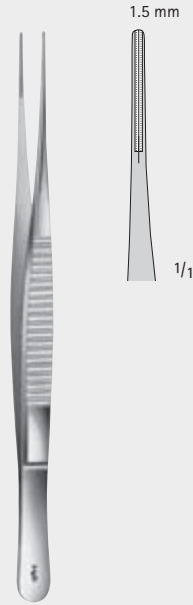

DE BAKEY
 FB411R
 150 mm, 6"



DE BAKEY
 FB400R
 150 mm, 6"

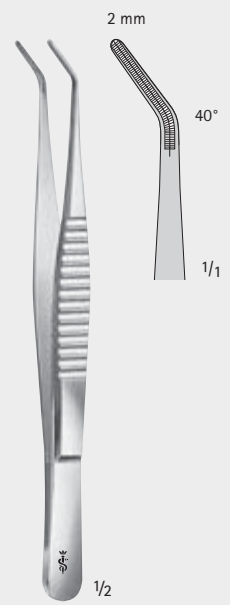

DE BAKEY
 FB401R
 150 mm, 6"



DX070R
 Atraumatisch, gerade
 Atraumata, straight
 180 mm, 7"



DX071R
 Atraumatisch, gebogen
 Atraumata, curved
 175 mm, 6 3/4"



ERGOPLANT
 DX052R
 120 mm, 4 3/4"



ERGOPLANT
 DX055R
 Für Weichgewebe
 For soft tissue
 140 mm, 5 1/2"



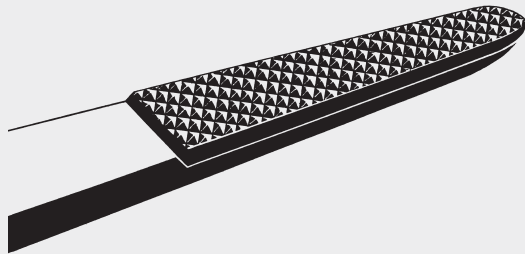

DUROGRIP®

DUROGRIP®-Pinzetten mit Hartmetall-Plättchen
Kennzeichnung: vergoldete Feder

DUROGRIP®-Dissecting Forceps with carbide inserts
Identification: gold-plated end



ERGOPLANT
DX052R
120 mm, 4 3/4"



ADSON
BD151R
120 mm, 4 3/4"



STANDARD
BD164R
145 mm, 5 3/4"

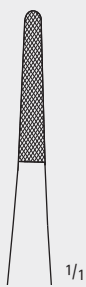

BD154R – BD157R



BD154R
145 mm,
5 3/4"



BD156R
180 mm,
7"



BD157R
200 mm,
8"



CUSHING
BD160R
180 mm, 7"



mit Schaber
with scraper end



DA254R
150 mm, 6"



DUROGRIP® ATRAUMATISCHE PINZETTEN, ERGOPLANT PINZETTE, CHIRURGISCHE PINZETTEN
 DUROGRIP® NON-TRAUMATIC DISSECTING FORCEPS, ERGOPLANT FORCEPS, SURGICAL FORCEPS

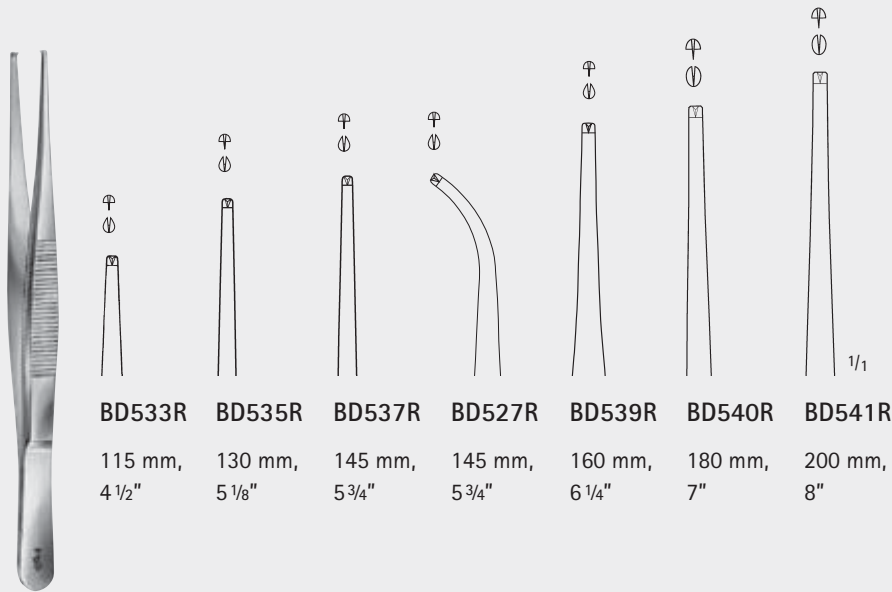

BD533R	BD535R	BD537R	BD527R	BD539R	BD540R	BD541R
115 mm, 4 1/2"	130 mm, 5 1/8"	145 mm, 5 3/4"	145 mm, 5 3/4"	160 mm, 6 1/4"	180 mm, 7"	200 mm, 8"



DX080R	DX081R
Chirurgisch, gerade Surgical, straight 180 mm, 7"	Chirurgisch, gebogen Surgical, curved 175 mm, 6 3/4"

BD527R – BD541R

Mittelbreit
Medium

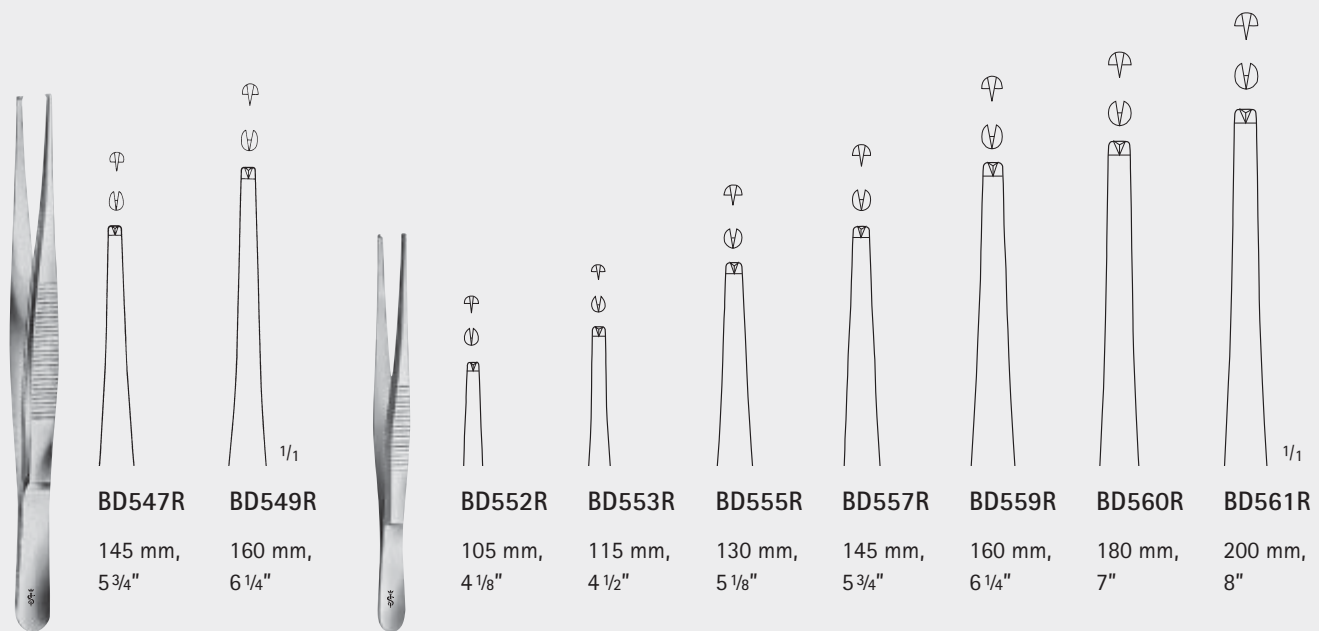

BD547R	BD549R	BD552R	BD553R	BD555R	BD557R	BD559R	BD560R	BD561R
145 mm, 5 3/4"	160 mm, 6 1/4"	105 mm, 4 1/8"	115 mm, 4 1/2"	130 mm, 5 1/8"	145 mm, 5 3/4"	160 mm, 6 1/4"	180 mm, 7"	200 mm, 8"

STANDARD

BD547R – BD549R

BD552R – BD561R



ZAHNÄRZTLICHE CHIRURGIE
DENTAL SURGERY



BD668R
125 mm, 5"



BD669R
145 mm, 5 3/4"



MC INDOE
BD661R
150 mm, 6"



GILLIES
BD660R
155 mm, 6"



BD670R
180 mm, 7"



BD671R
200 mm, 8"



GERALD
BD662R – BD663R
175 mm, 7"



BD663R

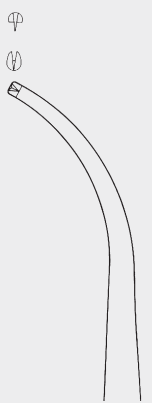

BROPHY
BD678R
200 mm, 8"

FEINE CHIRURGISCHE PINZETTEN, ERGOPLANT FEINE CHIRURGISCHE PINZETTEN
 DELICATE TISSUE FORCEPS, ERGOPLANT DELICATE TISSUE FORCEPS

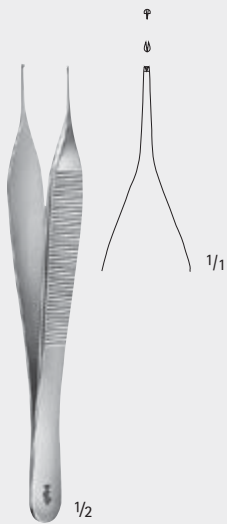

MICRO-ADSON
 BD510R
 120 mm, 4 3/4"

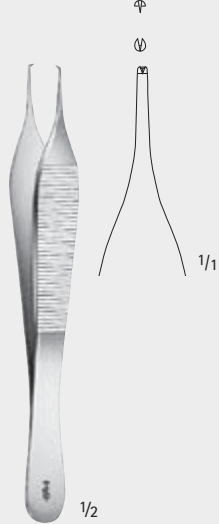

ADSON
 BD511R
 120 mm, 4 3/4"



ADSON
 BD512R
 120 mm, 4 3/4"

Mit Plateau
 With plateau

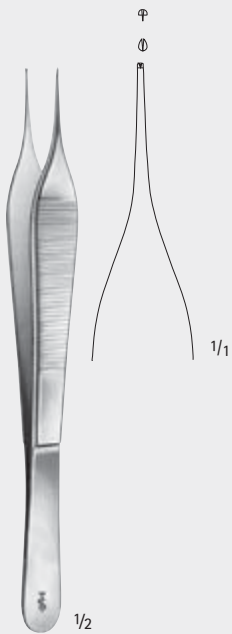

MICRO-ADSON
 BD520R
 150 mm, 6"

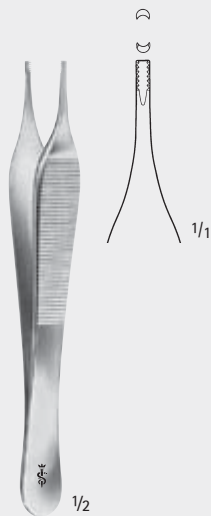

ADSON-BROWN
 BD700R
 120 mm, 4 3/4"

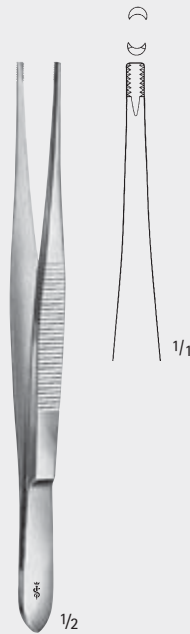

BROWN
 BD701R
 150 mm, 6"



ERGOPLANT
 DX050R
 120 mm, 4 3/4"



ERGOPLANT
 DX051R
 120 mm, 4 3/4"

Mit Plateau
 With plateau



ZAHNÄRZTLICHE CHIRURGIE
DENTAL SURGERY

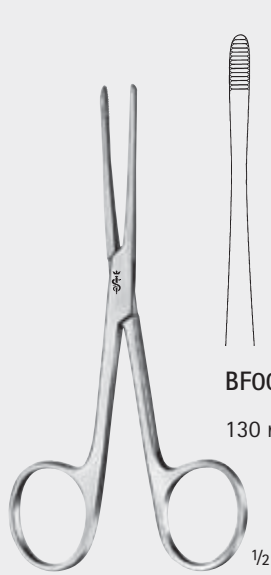

BF004R
130 mm, 5 1/8"

LISTER
BF004R – BF006R
Korn- und Tupferzange
Sponge and dressing forceps

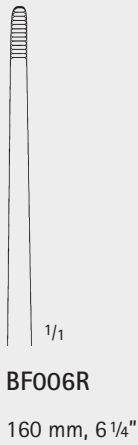

BF006R
160 mm, 6 1/4"



BF010R
ohne Sperre
without ratchet

BF010R
Korn- und Tupferzange
Sponge and dressing forceps
145 mm, 5 3/4"



BF016R
mit Sperre
with ratchet

BF016R
Korn- und Tupferzange
Sponge and dressing forceps
145 mm, 5 3/4"



BF021R
Korn- und Tupferzange
Sponge and dressing forceps
175 mm, 7"



GROSS
BF040R – BF041R
Korn- und Tupferzange
Sponge and dressing forceps
200 mm, 8"

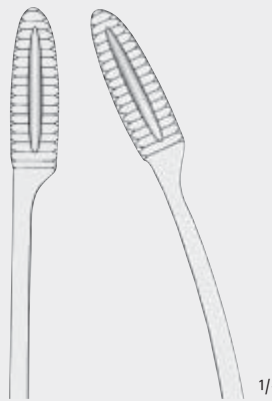

BF040R
ohne Sperre
without ratchet

BF041R
ohne Sperre
without ratchet

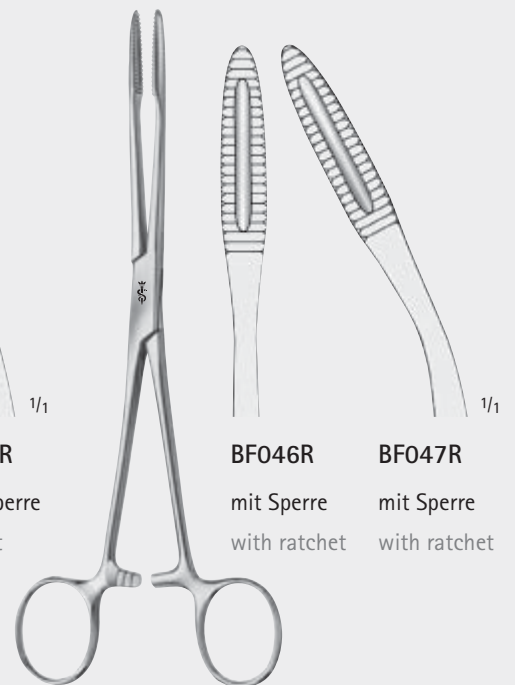

GROSS
BF046R – BF047R
Korn- und Tupferzange
Sponge and dressing forceps
200 mm, 8"

BF046R
mit Sperre
with ratchet

BF047R
mit Sperre
with ratchet

KORN- UND TUPFERZANGEN, TUCHKLEMMEN
 SPONGE AND DRESSING FORCEPS, TOWEL CLAMPS

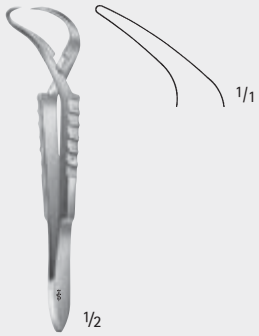

JONES
BF407R
 Tuchklemme
 Towel Clamp
 85 mm, 3 3/8"

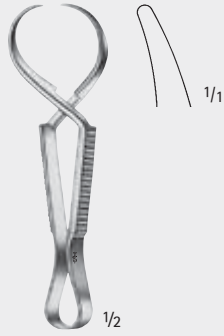

ENGL. MOD.
BF408R
 Tuchklemme
 Towel Clamp
 85 mm, 3 3/8"

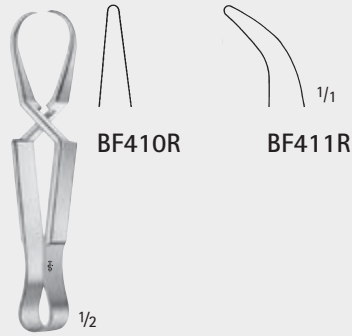

SCHAEDEL
BF410R – BF411R
 Tuchklemme
 Towel Clamp
 85 mm, 3 3/8"

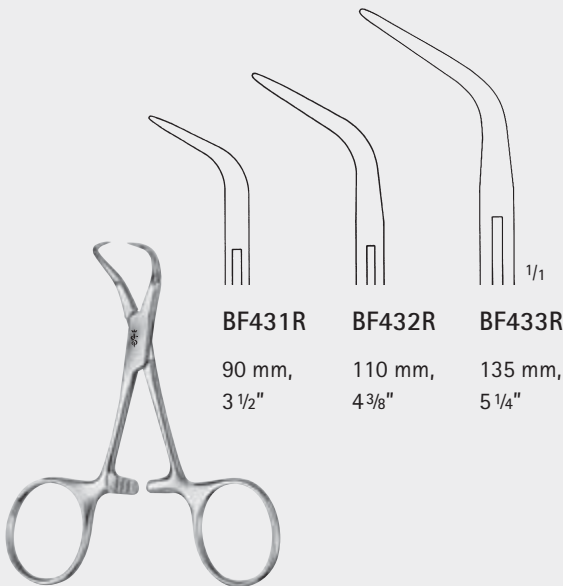

BACKHAUS
BF431R – BF433R
 Tuchklemme
 Towel Clamp

BF431R
 90 mm,
 3 1/2"

BF432R
 110 mm,
 4 3/8"

BF433R
 135 mm,
 5 1/4"



LORNA
BF461R
 Tuchklemme
 Towel Clamp
 95 mm, 3 3/4"

nicht perforierend
 non-perforating



BF464R
 Tuchklemme
 Towel Clamp
 140 mm, 5 1/2"

für Papiertücher
 for paper cloths



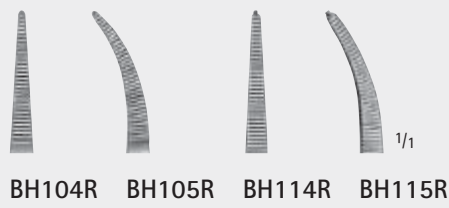

BABY-MOSQUITO (HARTMANN)
BH104R – BH115R
100 mm, 4"

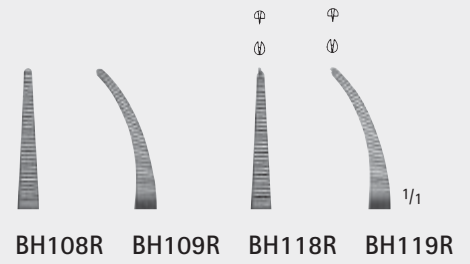

MICRO-HALSTED
BH108R – BH119R
125 mm, 5"

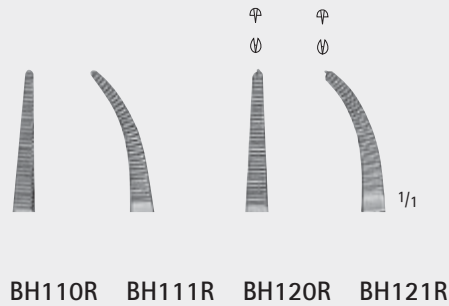

HALSTED-MOSQUITO
BH110R – BH121R
125 mm, 5"



PEEN
BH302R – BH304R
125 mm, 5" 140 mm, 5 1/2"

ARTERIENKLEMMEN
HAEMOSTATIC FORCEPS

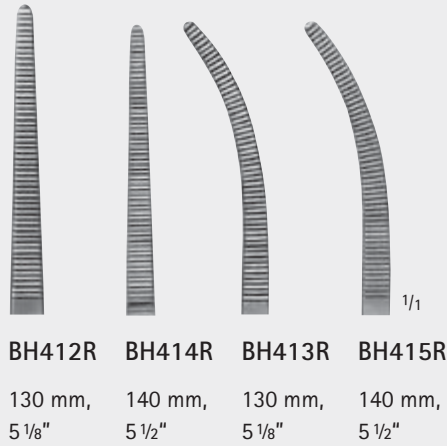

BH412R 130 mm, 5 1/8"
BH414R 140 mm, 5 1/2"
BH413R 130 mm, 5 1/8"
BH415R 140 mm, 5 1/2"

PEAN
BH412R – BH415R
 Grazile Form
 Slender type



BH134R – BH135R
 140 mm, 5 1/2"

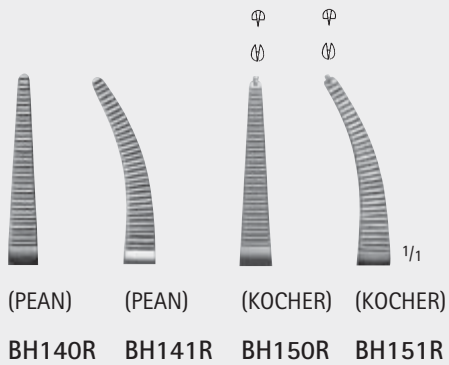

BABY-CRILE
BH140R – BH151R
 140 mm, 5 1/2"

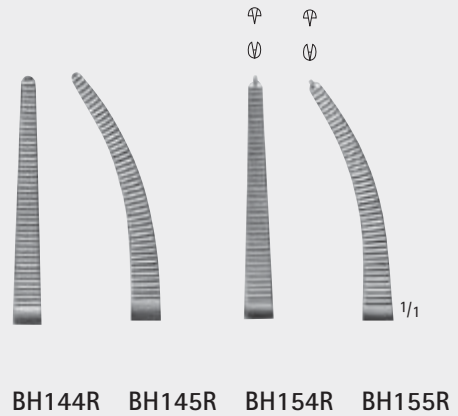

CRILE
BH144R – BH155R
 140 mm, 5 1/2"



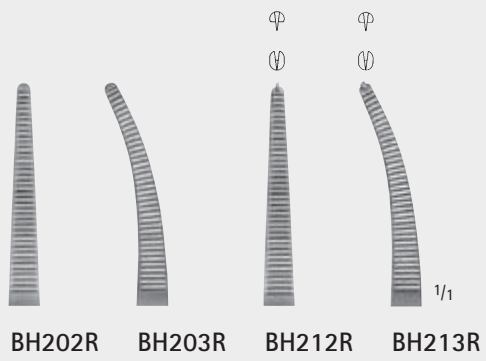

HALSTED
BH202R – BH213R
Arterienklemme
Haemostatic forceps
185 mm, 7 1/4"

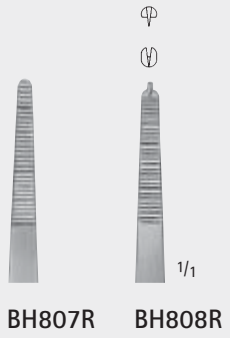

FICKLING
BH807R – BH808R
1 x 2 Zähne
1 x 2 teeth
Arterienklemme
Haemostatic forceps
180 mm, 7"



BABY-ALLIS
EA012R
Gewebefasszange
Tissue grasping forceps
130 mm, 5 1/8"



ALLIS
EA016R
Gewebefasszange
Tissue grasping forceps
155 mm, 6"

ARTERIENKLEMMEN, GEWEBEFASSZANGEN, DRAHT- UND LIGATURZANGE, AHLEN
 HAEMOSTATIC FORCEPS, TISSUE GRASPING FORCEPS, WIRE AND LIGATURE FORCEPS, AWLS

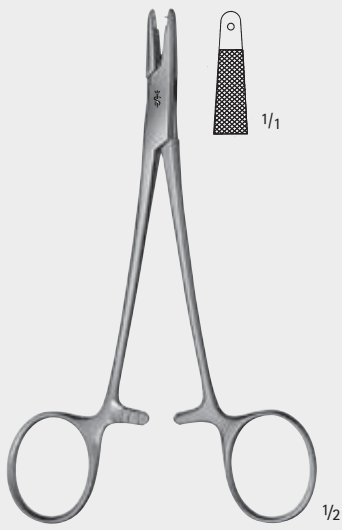

OBWEGESER
DO872R
 Draht- und Ligatur-
 zange
 Wire and ligature
 forceps
 140 mm, 5 1/2"

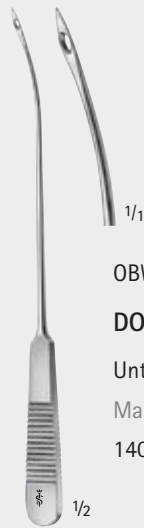

OBWEGESER
DO810R
 Unterkieferahle
 Mandibular awl
 140 mm, 5 1/2"



KORKHAUS
DP385R
 Draht- und Ligatur-
 zange
 Wire and ligature
 forceps
 165 mm, 6 1/2"

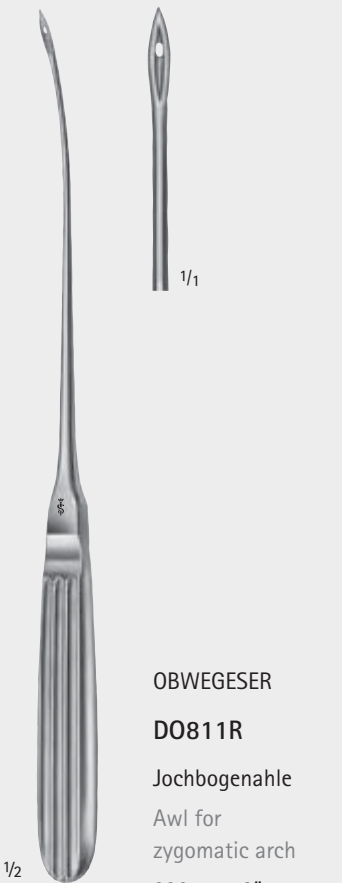

OBWEGESER
DO811R
 Jochbogenahle
 Awl for
 zygomatic arch
 230 mm, 9"



KELSEY FRY
DO813R
 Ahle, gerade
 Awl, straight
 150 mm, 5 1/2"



KELSEY FRY
DO814R
 Ahle, gebogen
 Awl, curved
 175 mm, 7"



OBWEGESER
DO812R
 Oberkieferahle
 Maxillary awl
 195 mm, 7 3/4"



ZAHNÄRZTLICHE CHIRURGIE
DENTAL SURGERY



PRICHARD
DX200R
Raspatorium
Raspatory
200 mm, 8"



PRICHARD
DB020R
Raspatorium
grazil
Raspatory
delicate
195 mm, 7³/₄"

RASPATORIEN
RASPATORIES



BUSER
DX201R
Raspatorium
Raspatory
185 mm, 7¼"



BUSER
DX301R
Mikro-Raspatorium
Micro-Raspatory
180 mm, 7½"



GLICKMAN
DB850R
Raspatorium
Raspatory
185 mm, 7¼"



ZAHNÄRZTLICHE CHIRURGIE
DENTAL SURGERY



MOLT
DB023R
Raspatorium
Raspatory
190 mm, 7½"



LANGE
DB022R
Raspatorium
Raspatory
190 mm, 7½"

RASPATORIEN, DESMOTOM
RASPATORIES, DESMOTOMES



FRETWURST
DB024R
Raspatorium/Desmotom
Raspatory/Desmotomes
190 mm, 7½"



FREER
DB025R
Raspatorium
scharf/stumpf
Raspatory
sharp/blunt
190 mm, 7½"



ZAHNÄRZTLICHE CHIRURGIE
DENTAL SURGERY

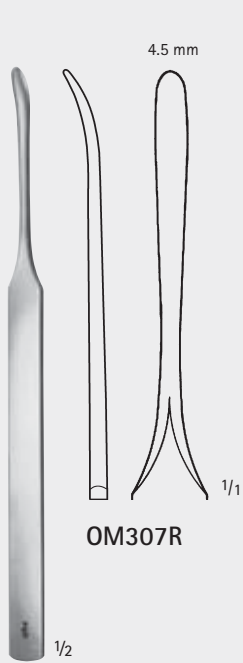

OM307R

KÖNIG
OM307R – OM308R
155 mm, 6"



OM308R

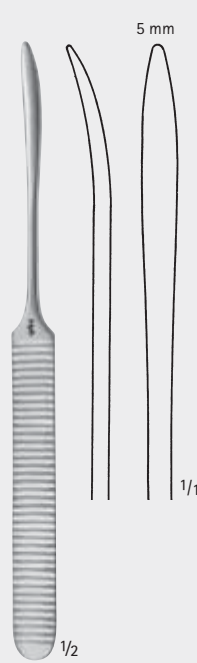

WILLIGER
FK120R

165 mm, 6 1/2"

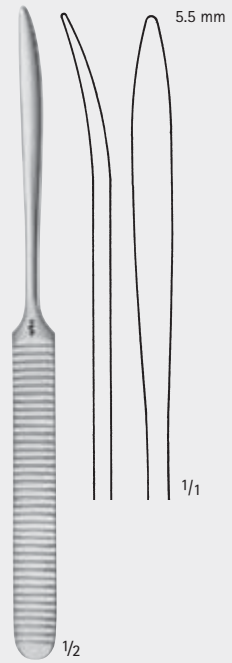

WILLIGER
FK121R

170 mm, 6 3/4"



FREER-YASARGIL
OL166R

185 mm, 7 1/4"



HALLE
OL160R

180 mm, 7"



SYME
DO547R

185 mm, 7 1/4"



OBWEGESER-FREER
OL169R

210 mm, 8 1/4"

ELEVATORIEN, RASPATORIEN
ELEVATORS, RASPATORIES

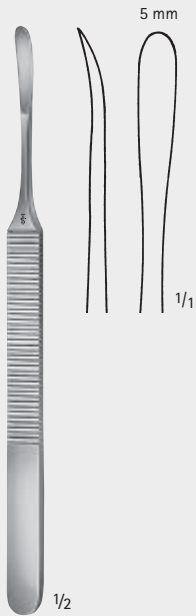

KÖNIG
OM309R
155 mm, 6"

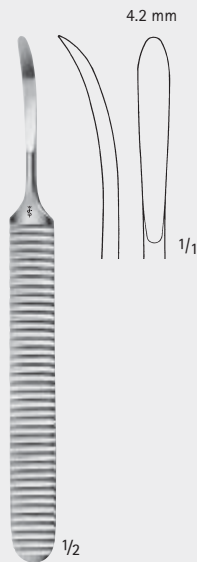

WILLIGER
DO510R
140 mm, 5 1/2"

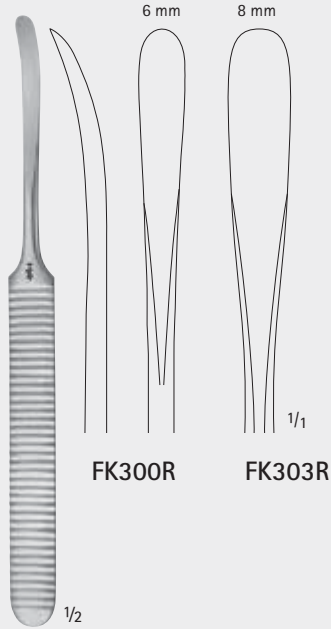

WILLIGER
FK300R – FK303R
160 mm, 6 1/4"

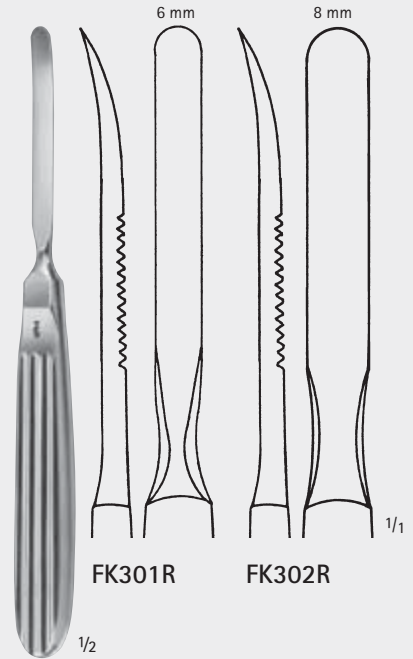

FK301R – FK302R
165 mm, 6 1/2"

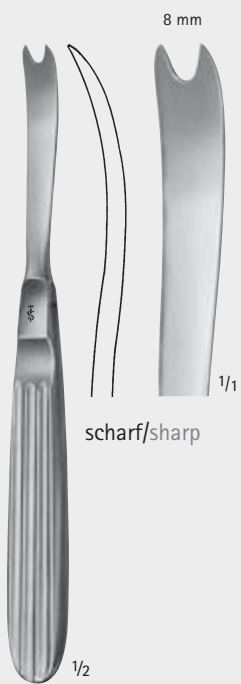

OBWEGESER
DO530R
170 mm, 6 3/4"

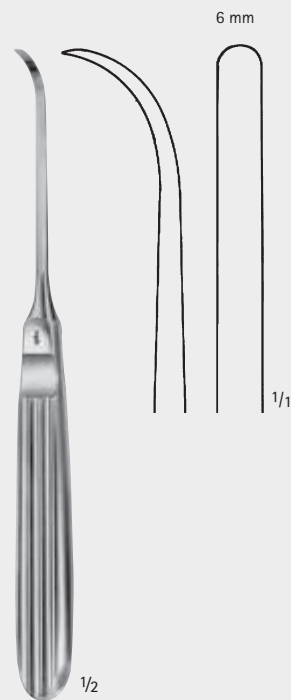

OBWEGESER
DO523R
170 mm, 6 3/4"



OBWEGESER
OL230R
Links
Left
190 mm, 7 3/4"



OBWEGESER
OL231R
Rechts
Right
190 mm, 7 3/4"



ZAHNÄRZTLICHE CHIRURGIE
DENTAL SURGERY

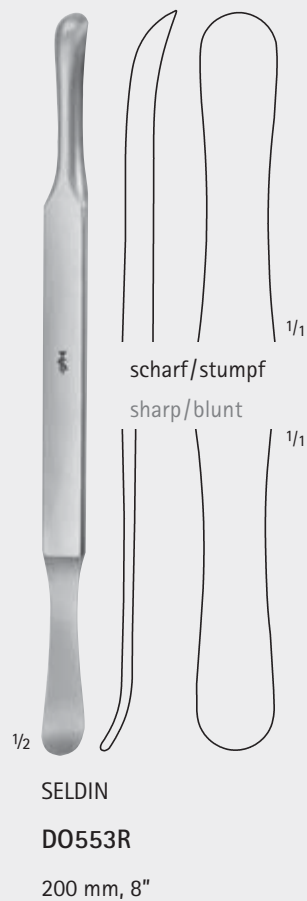
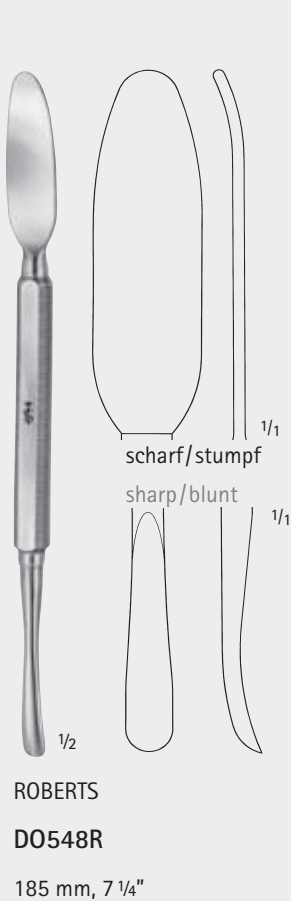
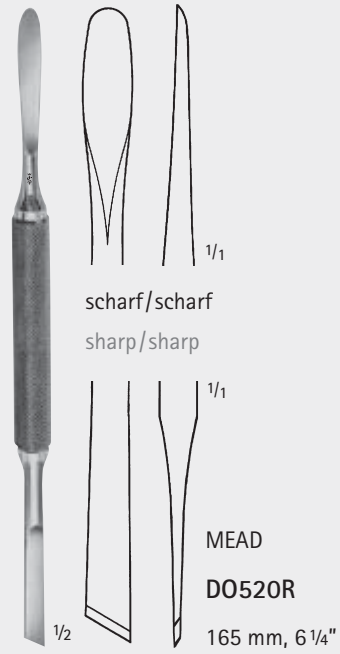
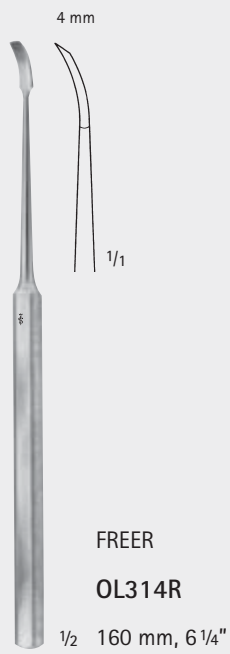
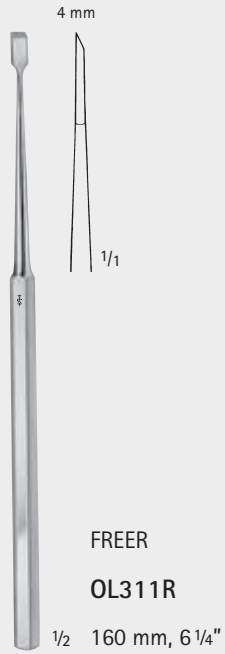

RASPATORIEN
RASPATORIES



FK394R
kurz gebogen
shortly curved
4 mm

MÜHLING
FK394R
1/2 170 mm, 6 3/4"

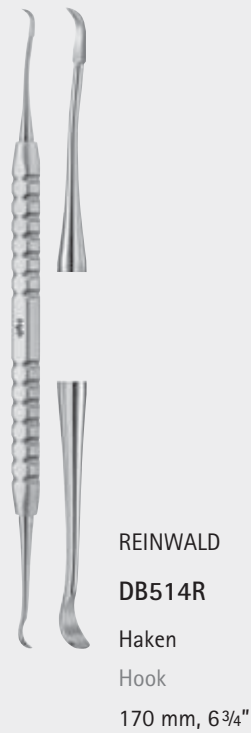

REINWALD
DB514R
Haken
Hook
170 mm, 6 3/4"

Anwendungszweck:

- Zum Lösen von Mucoperiostlappen (Schleimhautlappen)
- Bei der Resektion von Zysten usw.
- Für die Parodontalchirurgie

Range of application:

- For loosening parts of the mucosa
- For cyst resection
- For parodontal surgery

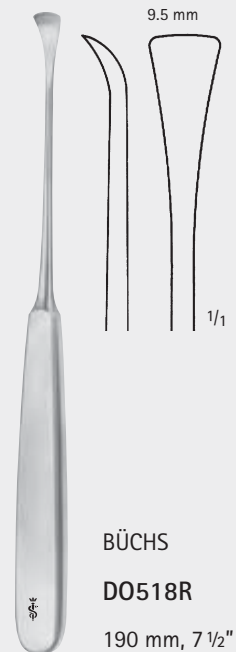

BÜCHS
DO518R
190 mm, 7 1/2"



OM314R
für Gaumen, links
for palate, left
140 mm, 5 1/2"

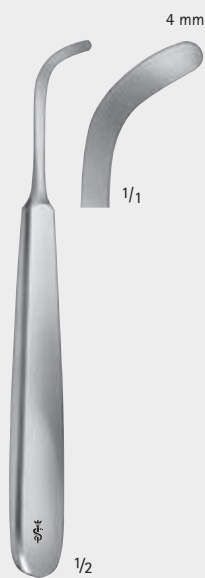

OM315R
für Gaumen, rechts
for palate, right
140 mm, 5 1/2"

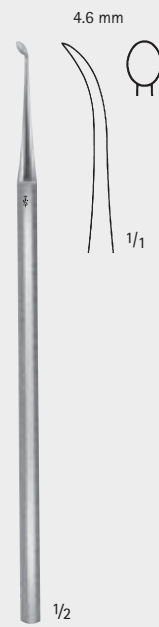

PARTSCH
DO612R
150 mm, 6"

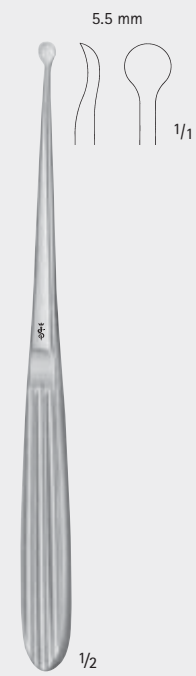

WARD
DO546R
170 mm, 6 3/4"



ZAHNÄRZTLICHE CHIRURGIE
DENTAL SURGERY



1/1 2/1

LUCAS

DO607R

Scharfer Löffel,
klein

Bone curettes,
small

180 mm, 7"



1/1

LUCAS

DO608R

Scharfer Löffel,
mittel

Bone curettes,
medium

180 mm, 7"



1/1

LUCAS

DO609R

Scharfer Löffel,
groß

Bone curettes,
large

180 mm, 7"

SCHARFE LÖFFEL
BONE CURETTES



HEMINGWAY

DO670R

Fig. 0

170 mm, 6³/₄"



HEMINGWAY

DO671R

Fig. 1

170 mm, 6³/₄"



HEMINGWAY

DO672R

Fig. 2

170 mm, 6³/₄"



HEMINGWAY

DO673R

Fig. 3

170 mm, 6³/₄"



HEMINGWAY

DO674R

Fig. 4

170 mm, 6³/₄"





DO650R

160 mm, 6 1/4"



JANSEN

DO651R

160 mm, 6 1/4"



HEMINGWAY

DO655R

170 mm, 6 3/4"



HEMINGWAY

DO656R

170 mm, 6 3/4"

SCHARFE LÖFFEL
BONE CURETTES

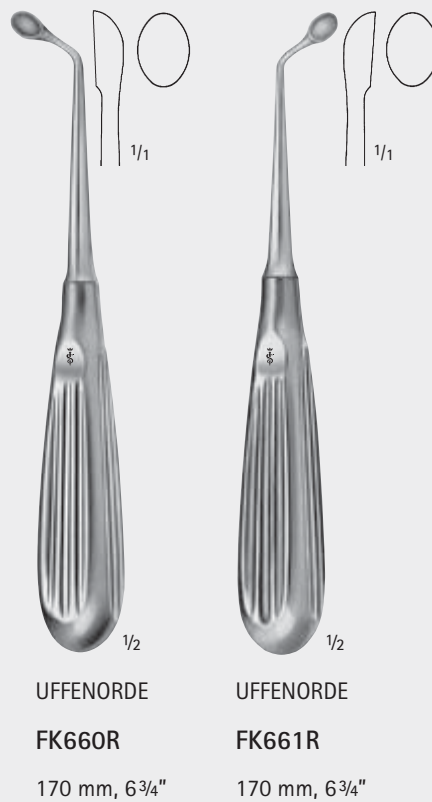
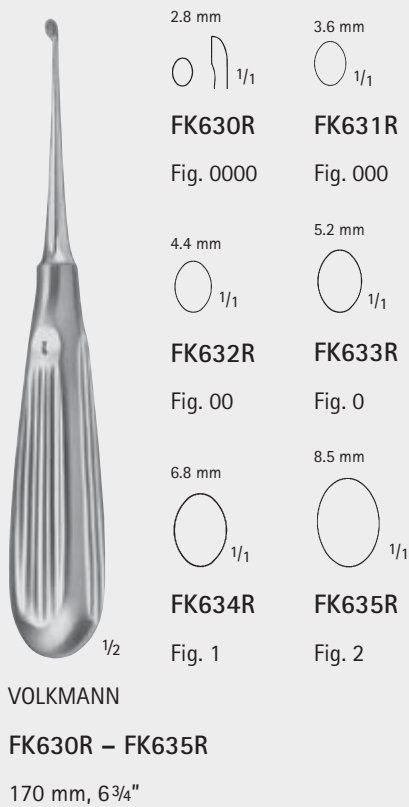
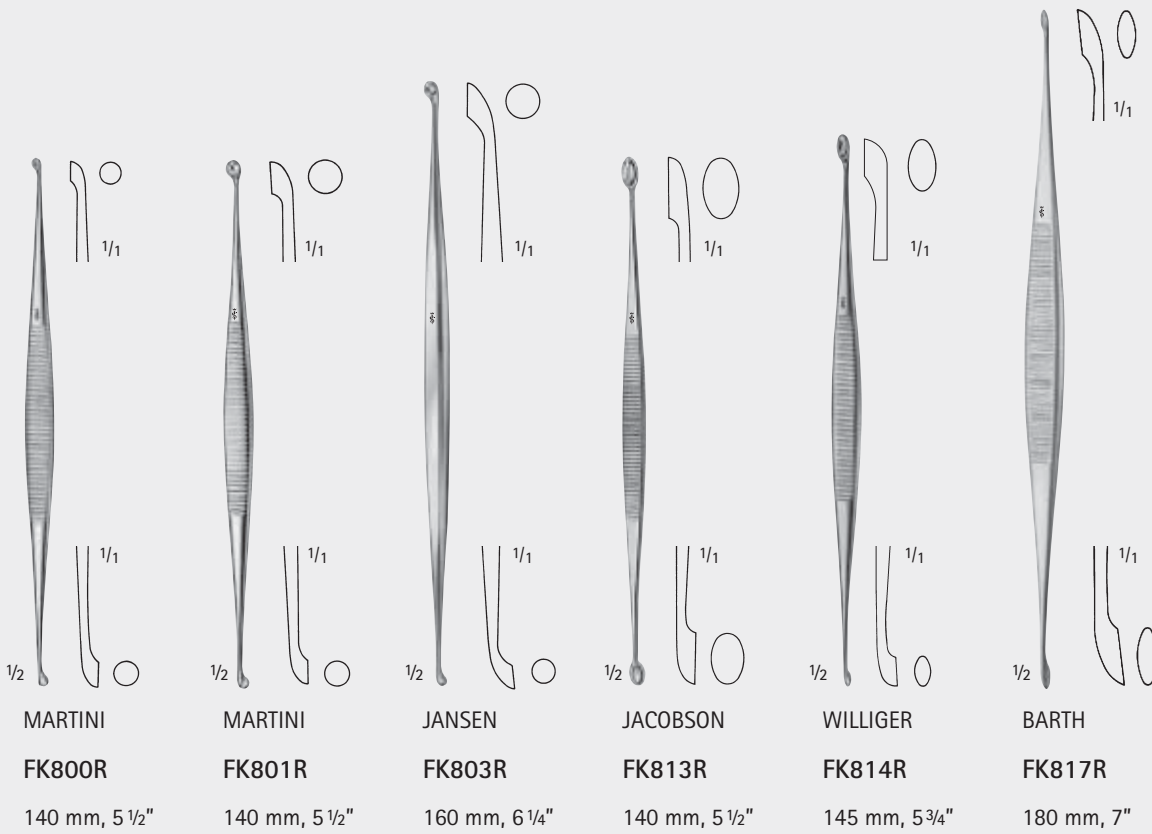

ZAHNÄRZTLICHE CHIRURGIE
DENTAL SURGERY



MILLER
DO606R
Scharfer Löffel
Bone Curette
180 mm, 7"

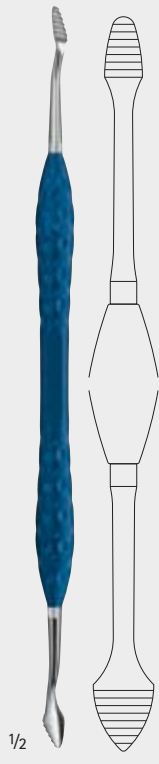

MILLER
DX252R
ERGOPLANT
Knochenfeile
ERGOPLANT
Bone file
195 mm, 7 3/4"

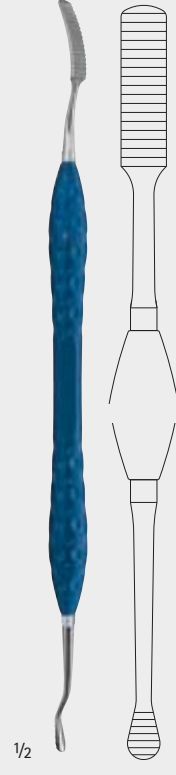

MILLER
DX253R
ERGOPLANT
Knochenfeile
ERGOPLANT
Bone file
200 mm, 8"



MILLER
DO771R – DO773R
Knochenfeilen
Bone files
180 mm, 7"



DO771R

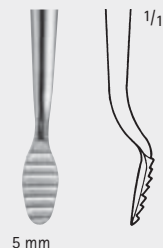

5 mm



DO772R



4.3 mm

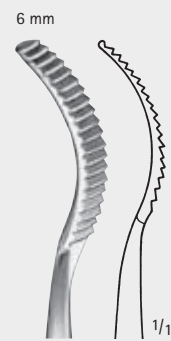

DO773R



5 mm

SCHARFE LÖFFEL, FEILEN, OSTEOTOME, MEISSEL
 BONE CURETTES, FILES, OSTEOTOMES, CHISELS



LAMBOTTE

- FL101R 4 mm
- FL102R 6 mm
- FL104R 8 mm
- FL106R 10 mm
- FL108R 12 mm
- FL109R 15 mm

Osteotome

Osteotomes

125 mm, 5"

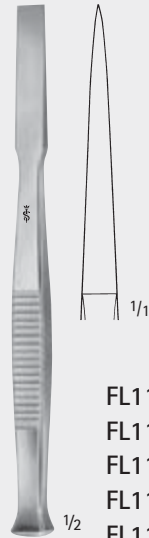

- FL110R 4 mm
- FL112R 6 mm
- FL114R 8 mm
- FL116R 10 mm
- FL118R 12 mm

Osteotome

Osteotomes

140 mm, 5 1/2"



PARTSCH

- FL173R 3 mm
- FL174R 4 mm
- FL175R 5 mm
- FL176R 6 mm

Flachmeißel

Chisels

140 mm, 5 1/2"



PARTSCH

- FL183R 3 mm
- FL184R 4 mm
- FL185R 5 mm
- FL186R 6 mm
- FL187R 7 mm

Flachmeißel

Chisels

170 mm, 6 3/4"

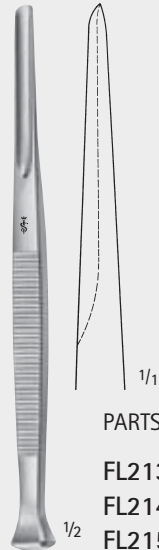

PARTSCH

- FL213R 3 mm
- FL214R 4 mm
- FL215R 5 mm
- FL216R 6 mm

Hohlmeißel

Gouges

140 mm, 5 1/2"

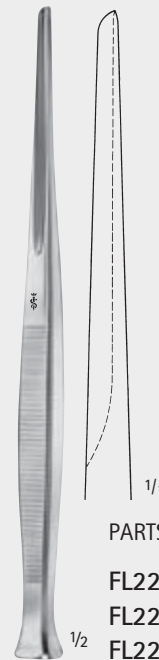

PARTSCH

- FL223R 3 mm
- FL224R 4 mm
- FL225R 5 mm
- FL226R 6 mm
- FL227R 7 mm

Hohlmeißel

Gouges

170 mm, 6 3/4"





FREER
OL311R 4 mm
Flachmeißel
Chisel
160 mm, 6 1/4"



1/1



FREER
OL314R 4 mm
Flachmeißel, gebogen
Chisel, curved
160 mm, 6 1/4"



1/1



LUCAS
DO711R 4 mm
Flachmeißel
Chisel
160 mm, 6 1/4"



1/1



LUCAS
DO715R 3 mm
Hohlmeißel
Gouges
160 mm, 6 1/4"



1/1

MEISSEL, OSTEOTOME
CHISELS, OSTEOTOMES

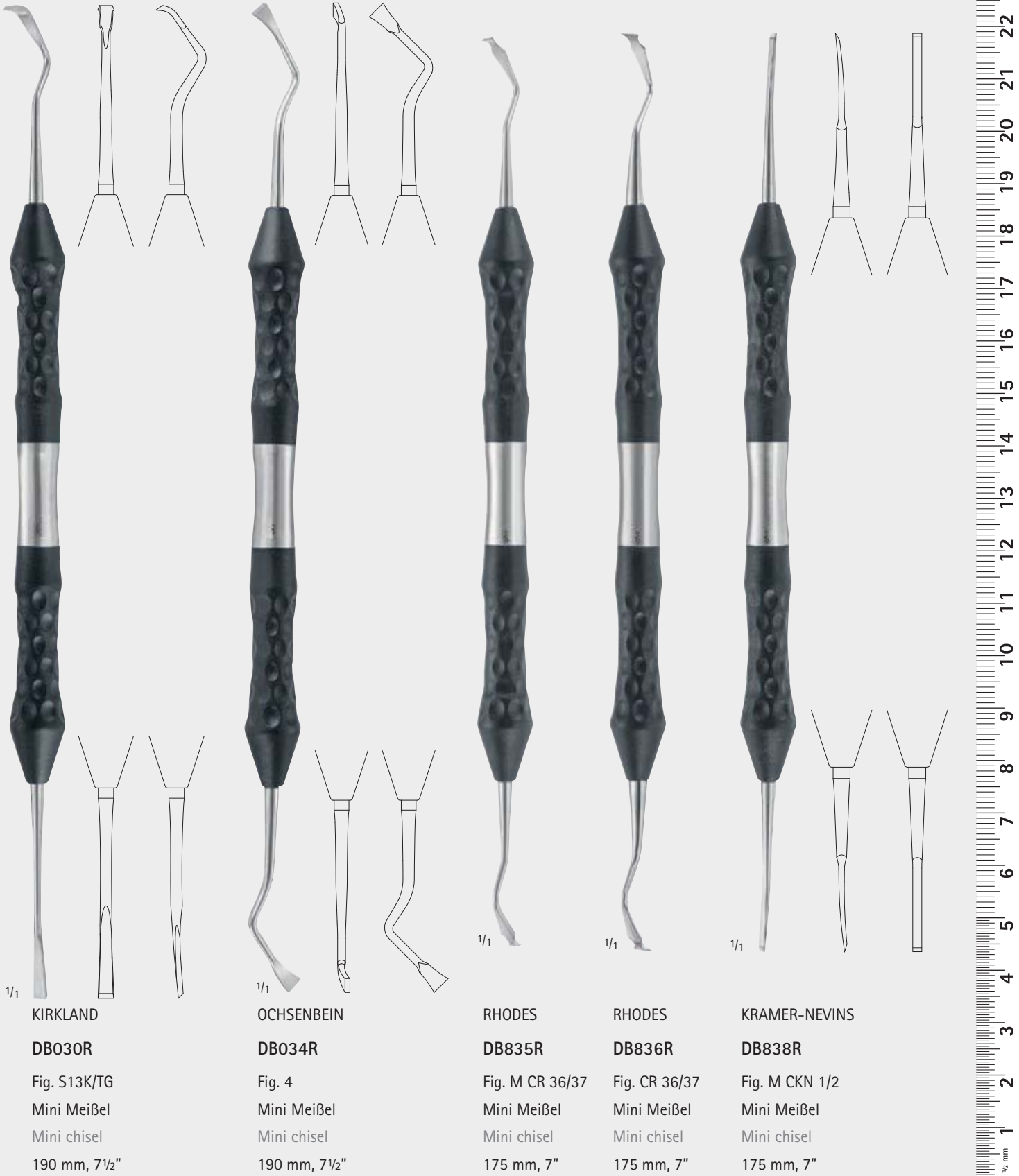

^{1/1}
KIRKLAND
DB030R
Fig. S13K/TG
Mini Meißel
Mini chisel
190 mm, 7½"

^{1/1}
OCHSENBEIN
DB034R
Fig. 4
Mini Meißel
Mini chisel
190 mm, 7½"

^{1/1}
RHODES
DB835R
Fig. M CR 36/37
Mini Meißel
Mini chisel
175 mm, 7"

^{1/1}
RHODES
DB836R
Fig. CR 36/37
Mini Meißel
Mini chisel
175 mm, 7"

^{1/1}
KRAMER-NEVINS
DB838R
Fig. M CKN 1/2
Mini Meißel
Mini chisel
175 mm, 7"



ZAHNÄRZTLICHE CHIRURGIE

DENTAL SURGERY

○ **FL093R**
Ø 3 mm

○ **FL094R**
Ø 5 mm

○ **FL095R**
Ø 7 mm

○ **FL096R**
Ø 9 mm

FL093R – FL096R

Stößel für Blutstillung
und Stopfer für
Knochenspäne

Tampers for bone grafts
can also be used as
haemostatic chisels

160 mm, 6 1/2"

□ **FL097R**
2.5 mm

1/1 □ **FL098R**
3.5 mm

PASSOW

FL097R – FL098R

Stößel für Blutstillung
und Stopfer für
Knochenspäne

Tampers for bone grafts
can also be used as
haemostatic chisels

120 mm, 4 3/4"

OBWEGESER

DO720R 11 mm

Osteotom, gebogen,
zum Vorbringen des
Oberkiefers

Pterygomaxillary
osteotome, curved, for
anterior displacement
of maxilla

235 mm, 9 1/4"

NIEDERDELLMANN

DO728R 8 mm

DO730R 10 mm

Osteotom, gebogen,
zur Sagittalspaltung des
Unterkiefers

Osteotomes, curved,
for sagittal splitting
procedure of the lower
jaw

250 mm, 10"

COTTLE

OL294R 4 mm

OL296R 6 mm

OL298R 8 mm

OL299R 10 mm

OL300R 12 mm

Osteotom mit
Graduierung

Osteotome with
depth markings
180 mm, 7"

COTTLE

OL301R 4 mm

OL302R 7 mm

OL303R 9 mm

OL304R 12 mm

Osteotom mit ein-
seitigem Anschliff
und Graduierung

Chisel-Osteotomes
with depth markings
180 mm, 7"

COTTLE

OL305R
6 mm

Osteotom mit
Graduierung

Osteotome with
depth markings
180 mm, 7"

**EAST GRINSTEAD
(WARD)**

DO722R
3 mm

DO723R
5 mm

Flachmeißel
Chisels

180 mm, 7"

**EAST GRINSTEAD
(WARD)**

DO732R
3 mm

DO733R
5 mm

Osteotome

Osteotomes
180 mm, 7"

Knochen­trans­plantat-Meißel
Chisels for bone trans­plan­ta­tion



- DO750R 10 mm
- DO752R 15 mm
- DO754R 20 mm

Meißel, gerade
mit PEEK-Griff
Chisel, straight
with PEEK-handle
200 mm, 8"

Knochen­trans­plantat-Meißel
Chisels for bone trans­plan­ta­tion



- DO751R 10 mm
- DO753R 15 mm
- DO755R 20 mm

Meißel, gebogen
mit PEEK-Griff
Chisel, curved
with PEEK-handle
200 mm, 8"



ZAHNÄRZTLICHE CHIRURGIE
DENTAL SURGERY



1/2

- OL390R 2 mm
- OL391R 3 mm
- OL392R 4 mm
- OL393R 7 mm
- OL394R 9 mm

Osteotom
Osteotomes

190 mm, 7 3/4"



1/2



1/1



1/1

D0704R

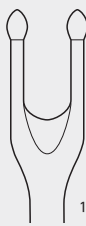

1/1

D0706R

D0704R 4 mm

D0706R 6 mm

Osteotom

Osteotome

185 mm, 7 1/4"

STÖSSEL, MEISSEL, OSTEOTOME
TAMPERS, CHISELS, OSTEOTOMES



1/2

TESSIER

- OL360R 2,5 mm
- OL361R 3,5 mm
- OL362R 5 mm
- OL366R 7 mm
- OL368R 10 mm
- OL370R 14 mm
- OL371R 18 mm

Osteotom, gerade
Osteotomes, straight
160 mm, 6 1/2"



1/2

TESSIER

- OL367R 7 mm
- OL369R 10 mm

Osteotom, gebogen
Osteotomes, curved
160 mm, 6 1/2"



ZAHNÄRZTLICHE CHIRURGIE

DENTAL SURGERY

Die Gewichtsangaben beziehen sich auf die Köpfe des jeweiligen Hammers

Weights refer to the heads of the mallets



Ø 22 mm

DF112R 80 g
165 mm, 6 1/2"

1/2



Ø 25 mm

DF114R 155 g
190 mm, 7 1/2"

1/2



Ø 25 mm

FLO36R 135 g/210 g
Mit auswechselbaren
Kunststoffbacken
With interchangeable
plastic disks
185 mm, 7 1/4"

1/2

FLO37
Ersatzbackenpaar
Pair of spare disks



Ø 20 mm

MEAD
FLO35R 160 g/350 g
Mit auswechselbaren
Kunststoffbacken
With interchangeable
plastic disks
190 mm, 7 1/2"

1/2

FLO34
Ersatzbackenpaar
Pair of spare disks

HÄMMER
MALLETS



Ø 30 mm

COTTLE

FL038R 235 g

1 Seite flach
1 Seite convex

1 Side flat
1 Side convex

185 mm, 7 1/4"

1/2



Ø 27 mm

HAJEK

FL044R 135 g

220 mm, 8 3/4"

1/2



Ø 25 mm

DX545R 135 g/415 g

ERGOPLANT Hammer mit aus-
wechselbaren Kunststoffbacken

ERGOPLANT Mallet,
with interchangeable plastic disks
200 mm, 8"

DX546

Ersatzbackenpaar
Pair of spare disks

1/2



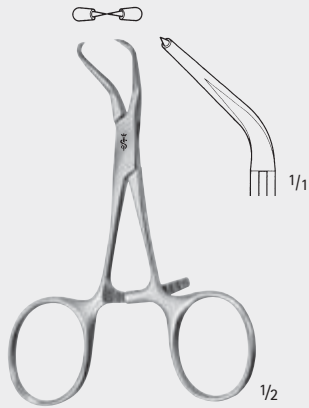

FO113R

Repositionszange mit abgesetzten Spitzen,
lange Sperre

Reposition forceps with stepped tips,
long ratchet

95 mm, 3 3/4"

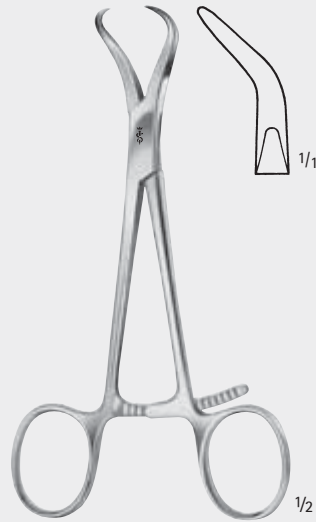

FO115R

Repositionszange für Kleinfragmente
Reposition forceps for small fragments

135 mm, 5 1/4"

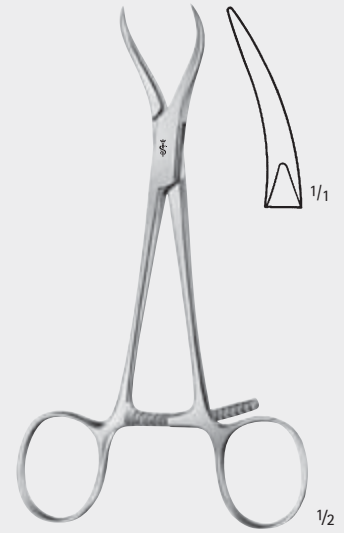

FO117R

Repositionszange,
speziell für Kieferrepositionen

Reposition forceps,
especially for maxillary reposition

135 mm, 5 1/4"

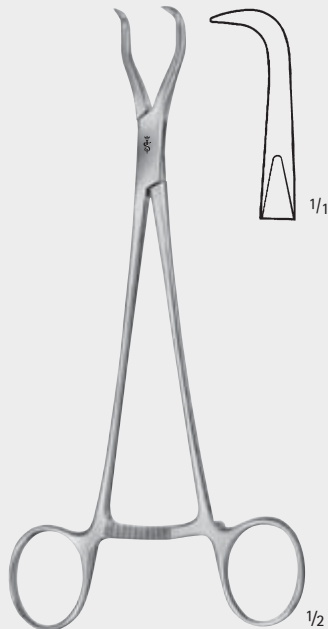

HAASE

FO119R

Repositionszange für Unterkieferfrakturen

Reposition forceps for mandibular fractures

165 mm, 6 1/2"

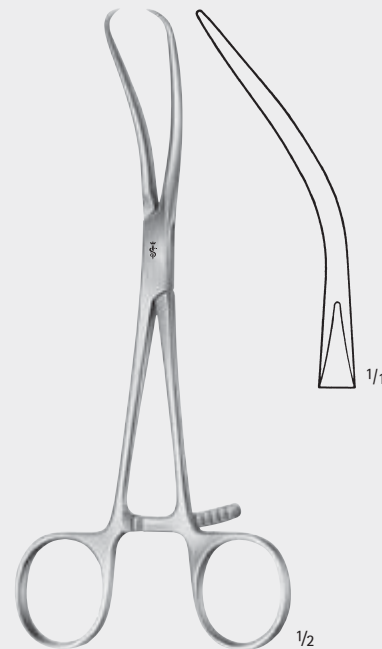

REILL

FO116R

Repositionszange

Reposition forceps

170 mm, 6 3/4"



REPOSITIONSZANGEN, KNOCHENHALTEZANGEN
 REPOSITION FORCEPS, BONE HOLDING FORCEPS



FO120R
 Knochenhaltezange
 Bone holding forceps
 200 mm, 8"



STRICKER
DX601R
 Knochenfixierzange
 Bone fixation forceps



SCHNITZER
DX602R
 Knochenbearbeitungszange
 Bone processing forceps



DINGMANN
FO110R
 Knochenhaltezange
 Bone holding forceps
 185 mm, 7 1/4"

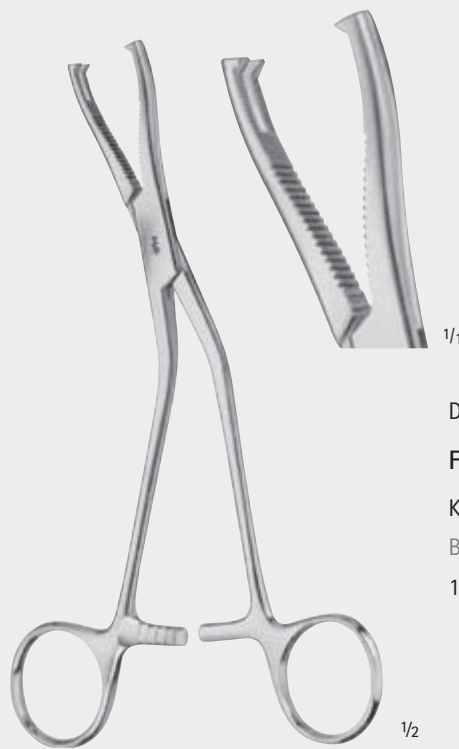

DINGMANN, modif.
FO111R
 Knochenhaltezange
 Bone holding forceps
 185 mm, 7 1/4"





LUER-FRIEDMANN
FO409R
145 mm, 5 3/4"



FO413R
150 mm, 6"



FO410R
140 mm, 5 1/2"



LUER
FO411R
150 mm, 6"

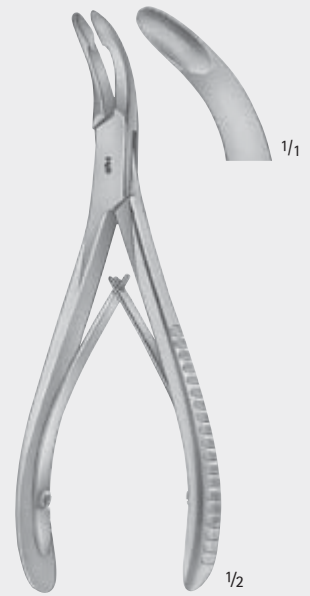

LUER
FO412R
155 mm, 6"

HOHLMEISSELZANGEN
BONE RONGEURS



SCHWARZ
FO408R
145 mm, 5 3/4"



BLUMENTHAL
FO415R
155 mm, 6"



BLUMENTHAL
FO416R
155 mm, 6"



STELLBRINK
FO399R
175 mm, 7"



STELLBRINK
FO400R
170 mm, 6 3/4"



BEYER
FO453R
180 mm, 7"



ZAHNÄRZTLICHE CHIRURGIE
DENTAL SURGERY

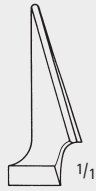

STAMM
FO604R
Knochensplitterzange
Bone cutting forceps
150 mm, 6"



MEAD
FO455R
Hohlmeißelzange
Bone rongeur
165 mm, 6 1/2"

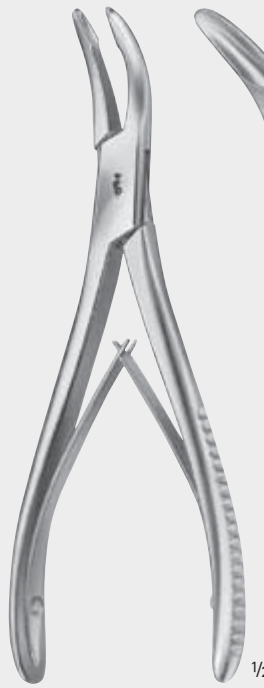

BANE-HARTMANN
FO457R
Hohlmeißelzange
Bone rongeur
175 mm, 7"



BEYER
FO514R



ZAUFGAL-JANSEN
FO515R

FO514R – FO515R
Hohlmeißelzange
Bone rongeur
180 mm, 7"

HOHLMEISSELZANGEN, KNOCHENSPLITTERZANGEN, NADELHALTER
BONE RONGEURS, BONE CUTTING FORCEPS, NEEDLE HOLDERS



HALSEY
BM205R
Nadelhalter
Needle holder
130 mm, 5 1/8"



BAUMGARTNER
BM215R
Nadelhalter
Needle holder
145 mm, 5 3/8"



CRILE-MURRAY
BM219R
Nadelhalter
Needle holder
150 mm, 6"





MAYO-HEGAR
BM235R – BM237R
Nadelhalter
mittelfeine Modelle
Needle holder
medium fine patterns

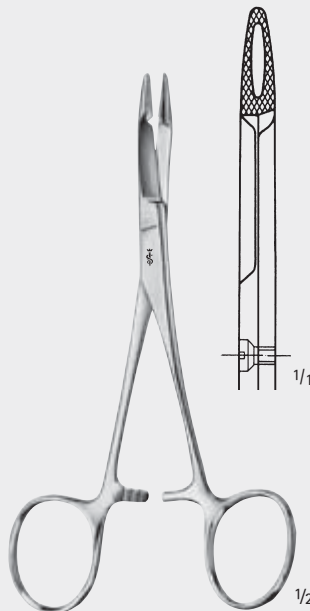

HEGAR-OLSEN
BM290R
Nadelhalter mit Schere
Needle holder with scissors
140 mm, 5 1/2"

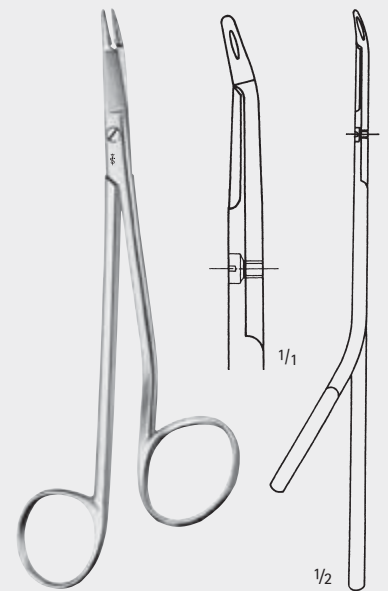

GILLIES
BM298R
Nadelhalter mit Schere
Needle holder with scissors
150 mm, 6"

NADELHALTER
NEEDLE HOLDERS



BM360R

140 mm, 5 1/2"



BM361R

170 mm, 6 3/4"



BM362R

200 mm, 8"

MATHIEU

BM360R – BM362R

Nadelhalter

Needle holder



CRILE

BM503R

Nadelhalter

Needle holder

150 mm, 6"



TOENNIS

BM510R

Nadelhalter, elastisches Modell

Needle holder, elastic pattern

180 mm, 7"



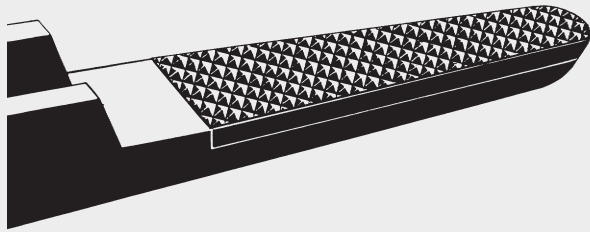

AESCULAP®-Nadelhalter sind durch die Struktur der Hartmetall-Maulteile auf das jeweilige, indikationsbezogene Nahtmaterial abgestimmt. Eine glatte Maulfläche sowie 3 verschiedene Haftprofile ermöglichen den „Griff“ der jeweiligen Nadel.

AESCULAP® needle holders have jaws with carbide inserts and according to the use required the resp. structure can be chosen. A smooth jaw surface as well as 3 different serrations enable a „grip“ of the respective needle.

DUROGRIP®

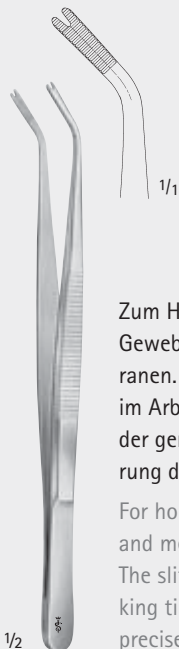

Zum Halten von Gewebe und Membranen. Der Schlitz im Arbeitsende dient der genauen Platzierung der Nadel.

For holding tissue and membranes. The slit in the working tip serves for precise positioning of the needle.

DA300R

Nahtpinzette, aufgebogen
Suture forceps, angled
150 mm, 6"



CASTROVIEJO

BM002R

DUROGRIP® Nadelhalter
DUROGRIP® Needle holder
145 mm, 5 1/4"



Wir empfehlen Hartmetall-Maulteile mit glatter Fläche für Nahtmaterial mit Teilung 0,2 mm für Nahtmaterial 0,4 mm 0,5 mm

We recommend carbide inserts

with smooth jaw surface for suture material with 0.2 mm pitch of serration for suture material 0.4 mm 0.5 mm

9/0 – 11/0
6/0 – 10/0
4/0 – 6/0
bis 3/0

9/0 – 11/0
6/0 – 10/0
4/0 – 6/0
up to 3/0

DUROGRIP® Nadelhalter mit Hartmetall-Plättchen

Kennzeichnung: Vergoldete Ringe, Branchenenden und Sperren

DUROGRIP® Needle holders with carbide inserts

Identification: gold-plated rings, handle ends and ratchets



BM003R

DUROGRIP® Nadelhalter
DUROGRIP® Needle holder
180 mm, 6 3/4"

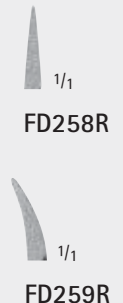

1/1

FD258R

1/1

FD259R

FD258R – FD259R

Mikro-Nadelhalter für Nahtmaterial von 6/0 – 8/0
Micro needle holder for suture material 6/0 – 8/0
180 mm, 7"

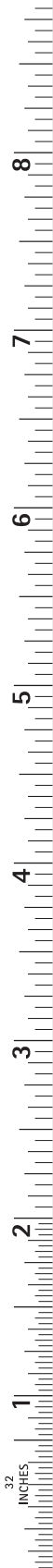

NAHTPINZETTE, DUROGRIP® NADELHALTER
 SUTURE FORCEPS, DUROGRIP® NEEDLE HOLDERS

»grazil«

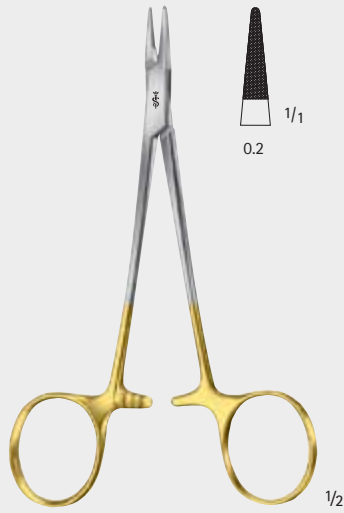

CONVERSE
BM011R
 sehr fein
 very delicate
 130 mm, 5 1/8"



HALSEY
BM012R
 130 mm, 5 1/8"

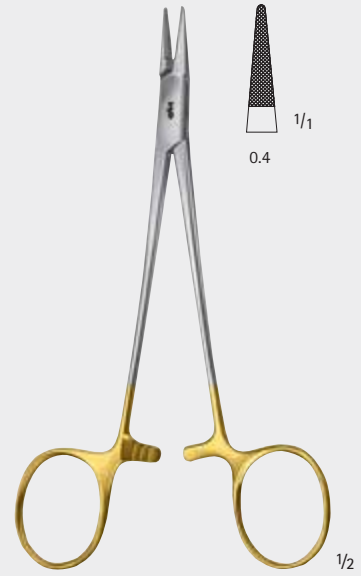

BABY-CRILE-WOOD
BM013R
 150 mm, 6"



CRILE-WOOD
BM016R
 145 mm, 5 3/4"



HEGAR-MAYO
BM065R – BM066R
 185 mm, 7 1/4"



SAROT
BM020R
 175 mm, 7"





DE BAKEY
BM033R – BM064R
sehr fein
very delicate



BM033R
165 mm, 6 1/2"



BM034R
210 mm, 8 1/4"



BM063R
165 mm, 6 1/2"



BM064R
210 mm, 8 1/4"



DE BAKEY
BM032R – BM035R



BM032R
150 mm, 6"



BM035R
180 mm, 7"

»grazil«



RYDER
BM054R – BM056R
sehr fein
very delicate



BM054R
135 mm, 5 1/4"



BM055R
155 mm, 6"



BM056R
175 mm, 7"



KILNER
BM018R
135 mm, 5 1/4"

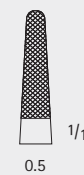

DUROGRIP® NADELHALTER
DUROGRIP® NEEDLE HOLDERS

Nadelhalter mit Schere,
ein Blatt fein gezahnt
Needle holder with
scissors, one blade fine
serrated



BM127R

Mit glattem Maul
With smooth jaws
125 mm, 5"

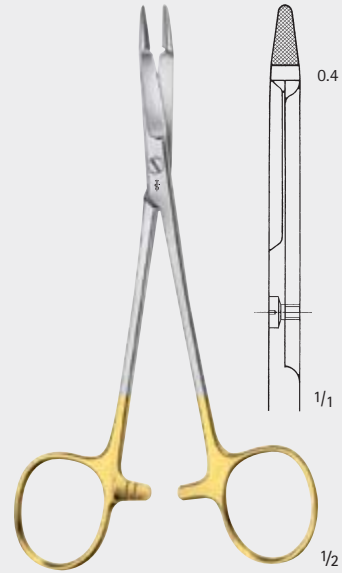

HEGAR-OLSEN modif. LANGE

BM128R

145 mm, 5 3/4"



HEGAR-OLSEN

BM124R

165 mm, 6 1/2"

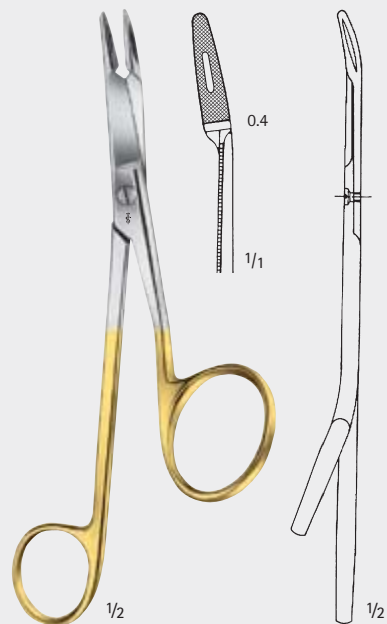

GILLIES

BM129R

160 mm, 6 1/4"





TOENNIS
BM186R
Elastisches Modell
Elastic pattern
180 mm, 7"



LANGENBECK
BM196R
200 mm, 8"

»grazi!«

DUROGRIP® NADELHALTER
DUROGRIP® NEEDLE HOLDERS

»grazil«

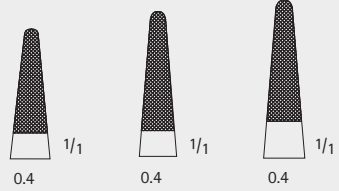
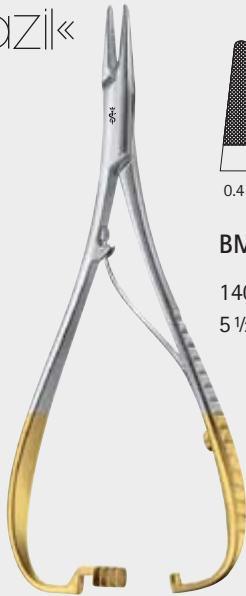

BM148R 140 mm, 5 1/2"
BM150R 170 mm, 6 3/4"
BM153R 200 mm, 8"

MATHIEU

BM148R – BM153R

DUROGRIP® Nadelhalter, feines Modell
DUROGRIP® Needle holder, delicate pattern

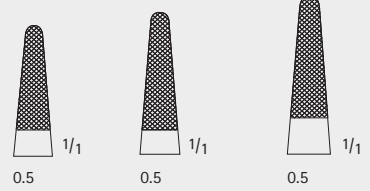
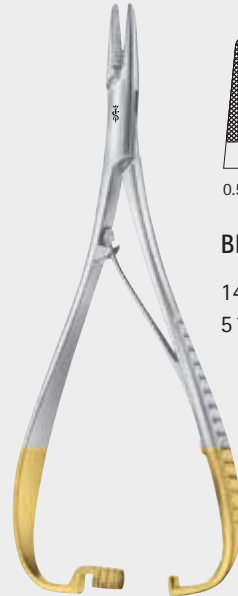

BM149R 140 mm, 5 1/2"
BM151R 170 mm, 6 3/4"
BM154R 200 mm, 8"

MATHIEU-STANDARD

BM149R – BM154R

DUROGRIP® Nadelhalter
DUROGRIP® Needle holder

»grazil«



LICHTENBERG
BM132R
DUROGRIP® Nadelhalter, elastisches Modell
DUROGRIP® Needle holder, elastic pattern
195 mm, 7 3/4"



HÖSEL
BM165R
DUROGRIP® Nadelhalter mit langem Hals
DUROGRIP® Needle holder with long neck
205 mm, 8"



ZAHNÄRZTLICHE CHIRURGIE
DENTAL SURGERY



BL907R 70 x 53 x 9 mm

Nadeldose
Needle case



BL941R 150 x 90 x 10 mm

Nadeldose
Needle case



BL910R 50 x 25 x 5 mm

BL911R 50 x 30 x 6 mm

BL915R 75 x 25 x 5 mm

Nadeldose
Needle case



BL930R 65 x 13 mm

BL932R 95 x 16 mm

Nadeldose komplett,
mit Innendose

Needle case complete,
with interior box

BL929R

-

Außendose allein,
unperforiert

Exterior box only,
non perforated



BL931R 62 x 11 mm

BL933R 90 x 14 mm

Innendose allein,
perforiert

Interior box only,
perforated

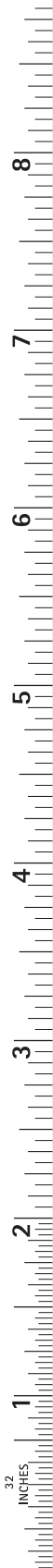



BOWMAN

- OB510 0.7 + 0.8 mm Ø, Fig. 00/0
- OB511 0.9 + 1.1 mm Ø, Fig. 1/2
- OB512 1.3 + 1.4 mm Ø, Fig. 3/4
- OB513 1.5 + 1.6 mm Ø, Fig. 5/6
- OB514 1.8 + 1.9 mm Ø, Fig. 7/8

Sonden, biegsam

Probes, malleable

130 mm, 5 1/8"



BN104R – BN136R

Knopfsonden

Probes

Knopf-Ø Ø of tips			Länge Length
1 mm	1.5 mm	2 mm	
-	BN113R	-	130 mm, 5 1/8"
BN104R	BN114R	BN134R	145 mm, 5 3/4"
-	BN116R	BN136R	160 mm, 6 1/4"





HAUER
DB776R

Medikamententräger
Medicine applicator
135 mm, 5 1/4"



STIEGLITZ
BD992R – BD993R

Splinterzange
Splinter forceps
140 mm, 5 1/2"

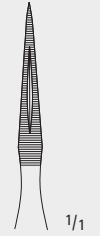

BD992R

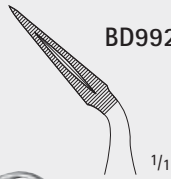

BD993R

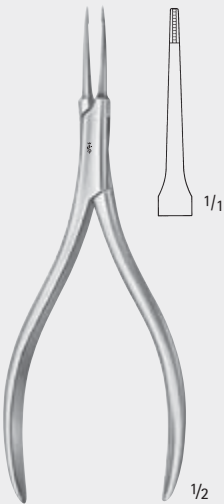

DA296R

Wurzelkanalinstrument
für abgebrochenes Wurzelkanal-
instrument
Nerve instrument
for broken nerve instrument
130 mm, 5 1/8"

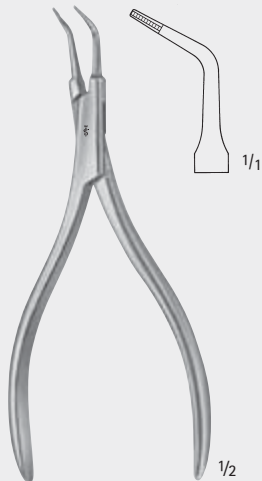

DA297R

Wurzelkanalinstrument
für abgebrochenes Wurzelkanal-
instrument
Nerve instrument
for broken nerve instrument
125 mm, 5"

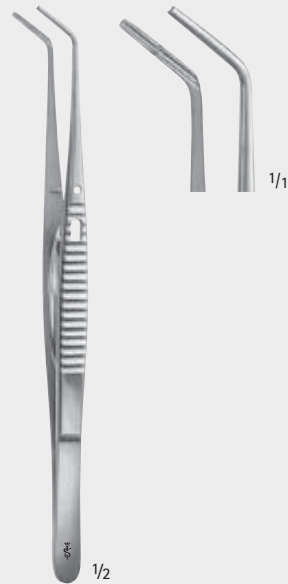

DA291R

Pinzette für Wurzelstifte
mit Schloss
Pin holding forceps
with lock
150 mm, 6"





ADSON

GF917R

mit Saugunterbrecher

with finger cut-off

190 mm, 7 1/2"



ADSON

GF919R

Ø 5,0 mm, Spitze 6,5 mm breit,
LUER-Bohrung

Ø 5.0 mm, tip 6.5 mm wide,
with LUER hub

180 mm, 7"





PLESTER

- GF939R Ø 1.5 mm
- GF940R Ø 2.0 mm
- GF941R Ø 2.5 mm
- GF942R Ø 3.0 mm

Mit Saugunterbrecher und Mandrin,
Griffplatte parallel zur Biegung, LUER-Bohrung

With finger cut-off and stylet,
thumb piece parallel to curve, with LUER hub

195 mm, 7³/₄"

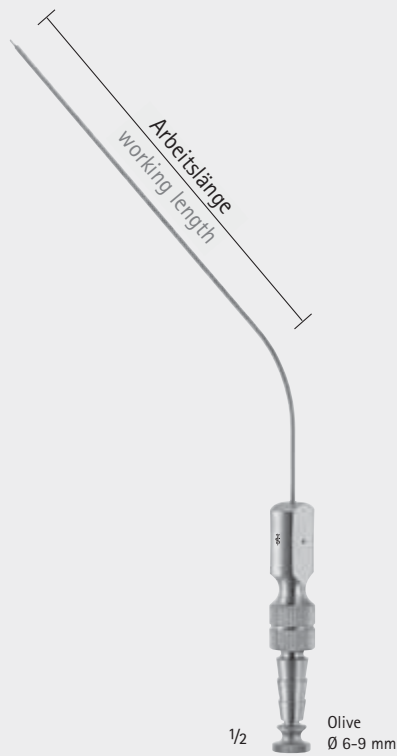

FERGUSSON

Ø	Arbeitslänge Working length	Arbeitslänge Working length
	110 mm, 4 ³ / ₈ "	130 mm, 5 ¹ / ₈ "
1.5 mm	GF350R	GF360R
2 mm	GF351R	GF361R
2.5 mm	GF352R	GF362R
3 mm	GF353R	GF363R
4 mm	GF354R	GF364R
5 mm	GF355R	GF365R

Mit Saugunterbrecher und Mandrin, Griffplatte 90° zur Biegung,
LUER-Bohrung

With finger cut-off and stylet, thumb piece 90° to curve, with
LUER hub

180 mm, 7"

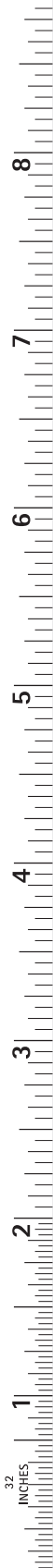

SAUGINSTRUMENTE, SPRITZEN SUCTION INSTRUMENTS, SYRINGES

AESCULAP® Zylinderampullenspritze „Aspira-plus II“ aus rostfreiem Instrumentenstahl (kein Chrom), mit Aspirationsvorrichtung

Nach Einschieben der Ampulle und Aufsetzen der Kanüle ist die Spritze injektionsbereit.

Durch leichtes Rechtsdrehen der Kolbenstange erfasst die Doppelkorkenzieherspitze den Moosgummikolben der Ampulle. Dadurch wird eine zuverlässige Aspiration ermöglicht.

Vorteile:

- Aufbereitung von rost- und säurebeständigem Instrumentenstahl anstelle von verchromten Material
- Umklappbare Hülse für Einführen und Auswerfen der Ampulle

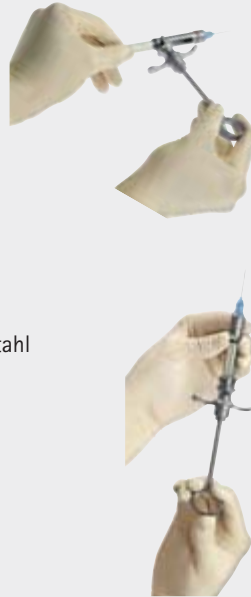

AESCULAP® Cartridge Syringe „Aspira-plus II“ made of stainless instrument-steel (no chrome), with aspiration device

After having inserted the ampulla and the cannula, the syringe is immediately ready for injection.

By a slight twist of the piston rod to the right the double corkscrew tip will grasp the foam rubber of the ampulla.

This enables a controlled aspiration.

Advantages:

- Processing by using corrosion- and acid resistant instrument steel instead of chrome material
- Cartridge insert and ejection by folding back the bush

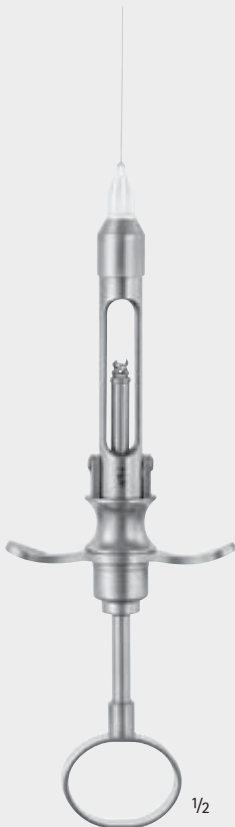

SL018R* 1.8 ml

SL022R* 2.2 ml

Spritze mit langem Kanülenkopf (SL002R)
Syringe with long needle attachment
(SL002R)

* Lieferung ohne Kanüle
Delivered without canula



SL118R* 1.8 ml

SL122R* 2.2 ml

Spritze mit Krückengriff, mit langem Kanülenkopf (SL002R)
Syringe with crutch handle, with long needle attachment
(SL002R)



SL002R*

Kanülenkopf, lang, geeignet für alle Einmalkanülen mit einem Gewindedurchmesser von 6 mm und langer Ampullen-Einstichkanüle (z. B. Sterican® Z, B. Braun etc.)

Needle attachment, long, suitable for all disposable needles with a thread diameter of 6 mm and long cartridge pick (e.g. Sterican® Z, B. Braun etc.)





SL028R* 1.8 ml
SL032R* 2.2 ml

Spritze mit kurzem
Kanülenkopf (SL033R)
Syringe with short needle
attachment (SL033R)



SL033R*

Kurzer Kanülenkopf allein, für
amerikanische Einmalkanülen mit
kleinem Gewinde (Ø 5,5 mm) und
kurzer Ampullen-Einstichkanüle
Short needle attachment only,
for American disposable needles
with small thread (Ø 5.5 mm) and
short cartridge pick



SL017R* 1.8 ml

Spritze ohne Kanülenkopf
Syringe without needle
attachment

* Lieferung ohne Kanüle
Delivered without canula



SL034R*

Kurzer Kanülenkopf allein, für
Einmalkanülen, mit großem
Gewinde (Ø 6 mm) und kurzer
Ampullen-Einstichkanüle.
Short needle attachment only,
for disposable needles, with
large thread (Ø 6 mm) and short
cartridge pick.

SPRITZEN, KLEINE SCHALE, LABORSCHALE
 SYRINGES, SMALL DISH, ROUND BOWLS



JG513R

Kleine Schale
 Abmessungen
 (oben x unten x Höhe)
 50 x 30 x 20 mm

Small dish
 50 x 30 x 20 mm



JG520R – JG525R

Laborschale
 Round bowls

	Inhalt (Liter) Capacity (litre)	Abmessungen in cm (oben x unten x Höhe) Dimensions in cm (upper x lower x height)
JG520R	0.02	4.0 x 2.8 x 1.9
JG521R	0.06	6.1 x 4.2 x 3.0
JG522R	0.16	8.3 x 5.4 x 4.1
JG523R	0.4	11.1 x 7.2 x 5.6
JG524R	1.0	15.1 x 10.0 x 7.3
JG525R	2.5	21.1 x 14.5 x 9.6



AESCULAP® Single Use Surgical Instruments



Weitere Informationen
finden Sie in unserem
Prospekt **C82001**

For further details see
brochure No. **C82002**

Gesamtkatalog Ambulante Chirurgie



Weitere Informationen
finden Sie in unserem
Prospekt **4008000**

For further details see
brochure No. **4008000**

AESCULAP® Power Systems

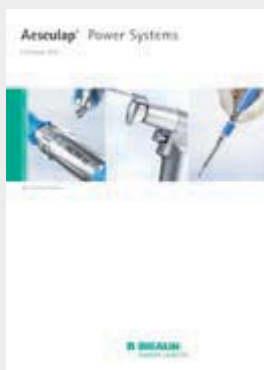

Weitere Informationen
finden Sie in unserem
Prospekt **O22701**

For further details see
brochure No. **O22702**

„Der rote Faden“



**Dentalchirurgische
Nähttechniken**

Stefan Beuer
Martin Stangl
teamwork media
dental publishing

